

ION[®]



Lighting Control Console Operations Manual

Version 2.0

Table of Contents

Introduction	1
Using this Manual	2
Register Your Ion	3
Help from ETC Technical Services	3
Important Concepts	4
Channel = Fixture	4
Output	4
Record Target	4
Move Instruction	4
Manual Data	4
Syntax Structure	4
Parameters and Parameter Categories	5
Tracking vs. Cue Only	5
Move Fade	6
Block vs. Assert	6
Live and Blind	7
HTP vs. LTP	7
Other Reference Materials	8
Help System	8
Online Eos Family (Eos Ti, Eos, Gio and Ion) User Forums	8

Chapter 1

System Overview	9
System Components	10
Console	10
Remote Processor Unit (RPU)	10
Remote Video Interface (RVI)	10
Radio Focus Remote (RFR)	10
iRFR and aRFR	10
Gateways	11
Console Geography	12
Terminology	13
Littlites®	14
Cleaning Ion	14
Outputting DMX	14
Console Capacities	15
Output Parameters	15
Channel Counts	15
Cues and Cue Lists	15
Record Targets	15
Faders	15



Chapter 2

System Basics	17
Setting Up the Hardware	18
Power	19
Power Up the Console	19
Power Down the Console	19
Your First Interaction	20
Single Monitor Configuration	20
Dual Monitor Configuration	21
The Central Information Area (CIA)	22
Parameter Display	22
Browser	22
Collapse/Expand the CIA	22
Lock the CIA	23
Favorite CIA Display	23
Locking the Facepanel	23
Using the Browser	24
Virtual Keyboard	24
Fader Module	25
Using Direct Selects	25
Direct Selects in Flexi Mode	26
Clear Functions	27
Display Control and Navigation	28
Opening and Closing Displays	28
Selecting Displays	29
Moving Displays	29
Scrolling within a Display	29
Expanding Displays	30
Zooming Displays	30
Graphical User Interface (GUI) Display Conventions	31
Indicators in the Live/Blind Display	31
[Data] Key	35
[Time] Key	35
[Label] Key	35
Using Flexichannel	36
Indicators in the Playback Status Display	37
Using [Format]	39
Encoders	45
Encoder Navigation	45
Locking the Encoders	45
Encoders in Blind	45
Flexi Encoders	45
Moving Light Controls	46
ML Controls	46
Using Softkeys	47
Context Sensitive Softkeys	47
Changing Softkey Pages	47

Chapter 3

Managing Show Files	49
Create a New Show File.	50
Open an Existing Show File	50
Selective Partial Show Opening	52
Merging Show Files	54
Printing a Show File	55
Saving the Current Show File.	57
Using Quick Save.	57
Using Save As	57
Importing Show Files	57
Exporting a Show File	58
Deleting a File	58
File Manager	58

Chapter 4

Patch.	59
About Patch	60
Displays	61
Flexichannel Views in Patch	62
Labeling	62
Patching Conventional Fixtures	63
Patching By Channel	63
Range Patching	63
Patching By Address	63
Using Output Address vs Port/Offset.	64
Replace	64
Helpful Hints	64
{Address} [n] [/]	64
Dimmer Doubling	65
Moving and Copying Channels	65
Swapping Channels.	66
Unpatch a Channel	66
Deleting Channels	66
Using {Offset} in Patch.	67
Creating multi-part and compound channels	67
Using the Scroller/Wheel Picker and Editor	68
Using the Picker.	68
Using the Editor	69
Calibrating a Scroller Using the Encoders.	72
Calibrating a Scroller Using the ML Display	74
Patching Moving Lights, LEDs, and Accessories	75
Display Pages in Patch	76
{Patch} Display and Settings	76
{Attribute} Display and Settings	78



{Database} Display and Settings	80
Using Device List	82
Dimmer List for CEM+, CEM3, and FDX 2000	82
RDM Device List	84
Patching Discovered Dimmers and RDM Devices	86
Errors and Warnings	86
Detaching Devices	87
Clearing the Patch	87
Reset Patch	87
Fixture Creator	88
Creating a New Fixture	88
Copying a Fixture	92
Merging Custom Fixtures into a New Show File	92
Importing a Custom Fixture	92
Update Library	92
Snap Parameters	93

Chapter 5 Setup 95

Opening Setup	96
Show	96
Desk	103

Chapter 6 Basic Manual Control 111

Selecting Channels	112
Select Channels From the Keypad	112
Selecting Channels from Faders	112
Using Groups as a Channel Collector	112
Offset	113
Setting Intensity	114
Level Wheel	114
Manual Control of Non-intensity Parameters (NPs)	115
Parameter Display	115
Setting Parameters with the Keypad	116
Adjusting Parameters Using + and -	116
Setting Non-intensity Parameters with the Encoders	116
Using the Color Picker	121
Home	123
Select Last	123
Multiple Intensity Channels	124
Lamp Controls	125
Using +% and -%	126
Channel Intensity	126
Non-intensity Parameters	126
Remainder Dim	127
Highlight and Lowlight	128

Lowlight Preset	128
Temporary Highlight Level	129
Highlight/Lowlight Rem Dim.	129
Sneak	130
Flip	131
Channel Check.	131
Address at Level.	131
Address Check.	131
Flash.	132
Flash On & Flash Off.	132
Using {Move To}.	132

Chapter 7

Using Groups 133

Recording Groups Live.	134
Ordered Channels	134
Offset	135
Editing and Updating Groups in Live	135
Selecting Groups	135
Deleting Groups.	135
Group List.	136
Open the Group List	136
Ordered View and Numeric View.	136
Editing Groups from the Group List	136
Using Groups as a Channel Collector	137

Chapter 8

Storing and Using Palettes 139

About Palettes	140
Palette Types	140
Intensity Palettes	140
Focus Palettes	140
Color Palettes	140
Beam Palettes	140
Palette Options	140
{By Type}	140
{Absolute}	140
{Locked}.	141
Storing Palettes Live	142
Storing Palettes with [Record]	142
Storing Palettes with [Record Only]	143
Using Filters with Palettes	144
Recalling Palettes.	145
Editing Palettes Live.	146
Rerecord	146



Update	146
Editing Palettes in Blind	147
Entering Blind Palette from Live	147
Editing in Blind	147
Editing Palettes in Spreadsheet View	148
Editing Palettes in List View	148
Deleting Palettes	149
Removing Channels from a Palette	149
Using By Type Palettes	150
Storing a By Type Palette	150
Editing By Type Palettes in Blind	150
Updating By Type Palettes	150

Chapter 9 Storing and Using Presets 151

Storing Presets Live	152
Storing Presets Using [Record]	152
Storing Presets using [Record Only]	153
Preset Options	153
Recalling Presets	154
Editing Presets Live	155
Rerecord	155
Update	155
Using the Preset List	156
Opening the Preset List	156
Editing Presets in Blind	157
Editing in Table View	157
Editing in Spreadsheet View	158
Deleting Presets	158
Removing Channels from a Preset	158

Chapter 10 Using Fan 159

About Fan	160
Fanning Parameter Data	160
Fan From the Command Line	160
Fanning References	161
Fanning Timing and Delays	161

Chapter 11 Working with a Single Cue List 163

Basic Cueing	164
Cue Numbering	164
Recording Cues in Live	165
Using Record	165
Using Record Only	166
Using Selective Store	167

Using [Cue Only / Track]	168
Timing.	169
Setting Cue Level Timing.	169
Non-intensity Parameter Category Timing.	170
Delay Time.	171
[Time][/]	171
Discrete Channel or Parameter Timing	172
Assigning Cue Attributes	173
Clearing Cue Attributes	175
Flags.	176
Block	176
Assert.	177
AllFade.	177
Mark.	177
Preheat	177
Using External Links	178
Modifying Cues Live	179
Using [At] [Enter]	179
Using Record.	179
Using Record Only.	180
Record and Record Only [+].	180
Move To.	180
[Update].	181
Recording and Editing Cues from Blind	186
From Summary or Table Views	187
From the Cue Spreadsheet	187
Using Encoders in Blind.	188
Deleting Cues.	189
In Track Mode	189
In Cue Only Mode	189

Chapter 12

Using Mark 191

AutoMark	192
Conditions Triggering an AutoMark.	192
Allowing a Live Move.	192
AutoMark and Timing.	192
Referenced Marks	193
Setting Referenced Mark Flags.	193
Applying Flags as Channels are Marked.	194
Reference Marks and Timing.	197
Mark Time	197

Chapter 13

Using Filters 199

Record Filters	200
Partial Filters	201
Removing Filters	201
Storing Data with Record Filters	201



Chapter 14	Working with Multiple Cue Lists	203
	Recording to a New Cue List	204
	Using Record	204
	Using Record Only.	204
	Using Assert	204
	Using AllFade	206
	Changing the Active Cue List	206
	Using [Go To Cue] with Multiple Cue Lists.	207
	Using Go To Cue 0	207
	Using Go To Cue Out	207
	Using the Cue List Index	208
	Open the Cue List Index	208
Chapter 15	Multipart Cues.	211
	About Multipart Cues	212
	Record a Multipart Cue in Live	212
	Creating a New Multipart Cue in Live	212
	Setting Multipart Cue Attributes	213
	Using Update in Live	213
	Storing a Multipart Cue in Blind	214
	Changing a Single Part Cue to a Multipart Cue.	214
	Changing a Multipart Cue to a Standard Cue	214
	Deleting a Part from a Multipart Cue	214
Chapter 16	Cue Playback	215
	Introduction to Playback.	216
	Playback Controls	216
	Selected Cue	217
	Live / Blind	217
	Out-of-Sequence Cues.	218
	Go To Cue	218
	Slider Module	220
	Assigning Faders.	220
	Changing Fader Pages	220
	Playback Fader Controls	221
	Go and Stop/Back	221
	Using Blackout.	221
	[Go To Cue] [0]	221
	Using Assert (Playback Button).	224
	Using Timing Disable.	224
	Using Freeze	224
	Using Stop Effect.	225
	Releasing Content From a Fader	225
	Using Rate Override	225
	Manual Master Cue Lists	226

Chapter 17	Advanced Manual Control	227
	Using [Copy To]	228
	Using [Recall From]	229
	Using {Make Null}	230
	In Live	230
	In Blind	230
	Using {Make Manual}	231
	Using {Make Absolute}	231
	Using {Query}	232
	Using [Capture]	233
	Using [Undo]	234
	Command History	234

Chapter 18	Using Park	235
	Using Park	236
	Park Display	236
	Parked Values in Live	236
	Scaled Parked Values in Live	237
	Parked Addresses in Live	237
	Park Values from the Park Display	238

Chapter 19	Creating and Using Effects	239
	About Effects	240
	The Effect List	240
	Effects Editor	241
	Effect Status Display	244
	Step Effects	245
	Program a Step Effect	246
	Absolute Effects	248
	Program an Absolute Effect	249
	Multiple Intensity HTP Effects	250
	Relative Effects	250
	Focus Effects	250
	Color Effects	251
	Linear Effects	251
	Define a Pattern Shape	252
	Program a New Relative Effect	252
	Apply an Existing Effect	253
	Recording an Effect in a Cue	253
	Editing Effects Live	253
	Stop an Effect	253
	Deleting an Effect	253
	Effects on Submasters	254



Configuring an Effect Submaster	254
Recording an Effect to a Submaster	254
Running an Effect from a Submaster	254
Delaying Effects	255

Chapter 20 Storing and Using Submasters 257

About Submasters	258
Recording a Submaster	258
Submaster Displays	259
Additive, Inhibitive, or Effectsub	259
Proportional vs. Intensity Master	259
HTP vs. LTP	260
Exclusive Submasters	260
Priority	260
Restore	261
Submaster Background State	261
Changing Fader Pages	262
On Fader Wings	262
On the Slider Module	262
Loading Submasters	263
On Fader Wings	263
On the Slider Module	263
Updating a Submaster	264
Releasing Content From a Submaster	264
Deleting a Submaster	264
Using Bump Button Timing With Submasters	265
Controlling Subfades Manually	265
Submaster List	266
Editing Submasters	266

Chapter 21 Using About 267

About [About]	268
[About]	269
About System	269
About Channel	270
About Address	272
About Cue	275
About IFCB Palettes	275
About Presets	275
About Groups	275
About Curves	276
About Effects	276

Chapter 22 Storing and Using Curves 277

About Curves	278
Creating and Editing Curves	279

Creating a Curve	279
Editing Curves	280
Applying a Curve	281
To Channels In Patch	281
To Cues	281
To Scroller Fans	281
Delete a Curve	281

Chapter 23 Storing and Using Snapshots 283

About Snapshots	284
Recording Snapshots	284
Recalling Snapshots	285
Editing Snapshots	285
Deleting Snapshots	285

Chapter 24 Storing and Using Macros. 287

About Macros	288
Store a Macro from Live	288
Using the [Learn] key	288
Macro Editor Display	290
Create a New Macro from the Display	292
Edit an Existing Macro	293
Play a Macro	294
Stop a Macro	294
Delete a Macro	294

Chapter 25 Using Magic Sheets 295

About Magic Sheets	296
Magic Sheet Display	297
Magic Sheet List	298
Display Tools	298
Navigating a Magic Sheet	299
Creating and Editing Magic Sheets	300
Quick Save	300
Layout Tools	301
Magic Sheet Object Library	303
MS Object Properties	307
Editing Objects on the Magic Sheet	308
Examples of Magic Sheets	309



Chapter 26	Virtual Media Server	311
	About Virtual Media Server	312
	Media Content	312
	Patching the Virtual Media Server and Layers	314
	Creating a Pixel Map	315
	Working with the Virtual Media Server.	317
	Effect Layers	322
	Pixel Mapping in a Multi-Console System	324
	Steps for Configuring a Multi-Console System	324
	Synchronizing Media Archives.	325
Chapter 27	Multiple Users	327
	About User ID	328
	Assigning User ID	328
Chapter 28	Using Partitioned Control	329
	About Partitioned Control	330
	How to Use Partitions	330
	Setting Up Partitioned Control	330
	Partition List	330
	Creating New Partitions	331
	Deleting Partitions	331
	Using Partitions	332
	Partitions in Playback	332
	Flexichannel in Partitioned Control	332
Appendix A	Eos Configuration Utility	333
	Overview	333
	What the Utility Does	333
	Eos Configuration Utility Reference	334
	General Settings.	336
	Network Settings	340
	Maintenance and Diagnostics	346
	Buttons	351
	Local I/O	351
	RFR	352
Appendix B	Facepanel Shortcuts	353
	Overview	353
	Facepanel and Displays.	353

Operations	354
------------------	-----

Appendix C **Multi-console and Synchronized Backup . 357**

Overview	357
Multi-console setup	358
Synchronized Backup.....	361
Mirror Mode	365

Appendix D **Using the RPU and RVI 367**

RPU Overview	367
Remote Processor Unit (RPU)	368
Start Up	369
Software Configuration.....	370
Basic Use Guidelines	371
Net3 Services	371
RVI3 and RVI Overview	372
Remote Video Interface 3 (RVI3)	372
Remote Video Interface (RVI)	373
Basic Use Guidelines for RVI3 and RVI.....	375

Appendix E **Remote Control..... 377**

Remotes Overview	377
Phone Remote.....	377
Radio Focus Remote (RFR)	378
Console Section Mode	379
Basic Use Guidelines	381
RFR Operation Modes	383
Technical Specifications.....	387
iRFR.....	388
aRFR	388

Appendix F **Universal Fader Wings 389**

Overview	389
1 x 20 Setup	389
2 x 10 and 2 x 20 Setup	389
User Guidelines for Fader Wings	392



Introduction

Welcome to the Ion Operations Manual. This manual is a comprehensive resource for users of the Ion control system.



Note:

For information on using show control with your system, see the Eos Family Show Control User Guide, which is available for download at www.etcconnect.com.

This chapter contains the following sections:

- ***Using this Manual*** 2
- ***Register Your Ion*** 3
- ***Help from ETC Technical Services*** 3
- ***Important Concepts*** 4
- ***Other Reference Materials*** 8
- ***Online Eos Family (Eos Ti, Eos, Gio and Ion) User Forums*** .8



Using this Manual

In order to be specific about where features and commands are found, the following naming and text conventions will be used:

- Facepanel buttons are indicated in bold **[brackets]**. For example, **[LIVE]** or **[Enter]**. Optional keys are indicated in **<angle brackets>**, for example, **<Cue>** or **<Sub>**.
- Browser menus, menu items, and commands you must perform are indicated in **bold text**. For example: In the **File** menu, click **Open**. Or: Press **[Record] [Preset] [Enter]**.
- Alphanumeric keyboard buttons are indicated in all CAPS. For example, TAB or CTRL.
- Keys which are intended to be pressed or held simultaneously are indicated with the “and” symbol. For example, **[Load] & [Timing Disable]**.
- Softkeys and clickable buttons in the Central Information Area (CIA) are indicated in bold **{braces}**. A note about **<More SK>** (more softkeys): this command is always indicated as optional, and is only indicated once in an instruction regardless of how many pages of softkeys exist. This is because there is no way to predict what softkey page you are on at any given time. Press **<More Softkeys>** until you find the required command.
- References to other parts of the manual are indicated in *italics*. When viewing this manual electronically, click on the reference to jump to that section of the manual.



Note: *Notes are helpful hints and information that is supplemental to the main text.*



CAUTION: *A Caution statement indicates situations where there may be undefined or unwanted consequences of an action, potential for data loss or an equipment problem.*



WARNING: *A Warning statement indicates situations where damage may occur, people may be harmed, or there are serious or dangerous consequences of an action.*

Please email comments about this manual to: TechComm@etconnect.com

Register Your Ion

Registering your Ion system with ETC ensures that you will be notified of software and library updates, as well as any product advisories.

To register your console, you will need to enroll in “My ETC,” a personalized ETC Web site that provides a more direct path of communication between you and ETC.

Register now at <http://www.etcconnect.com/product.registration.asp>.

Help from ETC Technical Services

If you are having difficulties, your most convenient resources are the references given in this user manual. To search more widely, try the ETC Web site at www.etcconnect.com. If none of these resources is sufficient, contact ETC Technical Services directly at one of the offices identified below. Emergency service is available from all ETC offices outside of normal business hours.

When calling for assistance, please have the following information handy:

- Console model and serial number (located on back panel)
- Dimmer manufacturer and installation type
- Other components in your system (Unison®, other control devices, etc.)

Americas

Electronic Theatre Controls Inc.
Technical Services Department
3031 Pleasant View Road
Middleton, WI 53562
800-775-4382 (USA, toll-free)
+1-608 831-4116
service@etcconnect.com

United Kingdom

Electronic Theatre Controls Ltd.
Technical Services Department
26-28 Victoria Industrial Estate
Victoria Road,
London W3 6UU England
+44 (0)20 8896 1000
service@etceurope.com

Asia

Electronic Theatre Controls Asia, Ltd.
Technical Services Department
Room 1801, 18/F
Tower 1, Phase 1 Enterprise Square
9 Sheung Yuet Road
Kowloon Bay, Kowloon, Hong Kong
+852 2799 1220
service@etcasia.com

Germany

Electronic Theatre Controls GmbH
Technical Services Department
Ohmstrasse 3
83607 Holzkirchen, Germany
+49 (80 24) 47 00-0
techserv-hoki@etcconnect.com

Important Concepts

Before using Ion, you should read and familiarize yourself with the concepts defined below. You will find that understanding these terms and concepts will improve your efficiency with Ion.

Channel = Fixture

A fixture is defined as a group of related addresses that together control a device. An example of a fixture would be an ETC Revolution. This moving light contains 31 parameters that together allow you to perform various functions such as pan and tilt. Each of these attributes is addressed by a different output.

Ion treats fixtures and channels as one and the same. Unlike former ETC consoles where a fixture occupied one channel for each parameter, Ion assigns each fixture a single channel number. Individual parameters are then associated with that channel as additional lines of channel information.

Output

Outputs are the method by which level changes to channels are conveyed to attached devices. These outputs are patched to channels. In its simplest form, an output is the data signal sent from the console to turn on a light or modify a fixture parameter.

Record Target

A record target is any data location that you can store data using a **[Record]** or **[Record Only]** command. Examples of record targets are cues, palettes, presets, and macros.

Move Instruction

A move instruction is any change to a parameter from its previous stored value. Any change to a channel's intensity is a move instruction. Any change to a channel's pan or tilt is a move instruction. Any change to a channel's color mixing is a move instruction, and so on.

Manual Data

Manual data is any value set for a channel via the command line. Manual data will remain at its value until a move instruction is provided for it.

Syntax Structure

Most instructions can be entered into Ion through the command line. The Ion command line expects instructions to be entered in a specific structure, or syntax.

Generally speaking, the order of syntax can be described as:

- What are you trying to affect? (Channel, group)
- What do you want it to do? (Change intensity, focus, pan and tilt)
- What value do you want? (Intensity at full, Iris at 50)

Naturally other commands will be used in the course of programming your show, but most other functions are modifiers of these three basic steps: modifying the channel(s) you are working with, determining what parameters of those channels you are impacting, and what value you want them to assume. When working with record targets, the syntax is similar.



Note:

Not all actions on Ion must be entered from the command line, although many will result in a command line instruction. Other actions bypass the command line entirely.

Enter

Since the command line can receive multiple edits and instructions at once, it is necessary to let Ion know when you have completed your instruction in the command line. This is done with the **[Enter]** key.

There are some commands which are self-terminating, and therefore do not require **[Enter]** to be pressed. Some (but not all) of these commands are:

- **[Out]**
- **[Shift] & [+]**
- **[Shift] & [-]**
- **[Full] [Full]**
- Actions from the direct selects

Parameters and Parameter Categories

Ion divides fixture parameters into four major *parameter categories*: Intensity, Focus, Color, and Beam. These are the parameters in each category:

- Intensity Intensity
- Focus Pan and Tilt
- Color. All color parameters (such as color wheel, CMY, scrollers, and so on).
- Beam Any parameter not covered in the other categories.

Tracking vs. Cue Only

Ion is, by default, a tracking console. This means two things. First, tracking relates to how cue lists are created. Once data is in a cue list, it will remain a part of that cue list, at its original setting, and track forward through subsequent cues, until a new instruction is provided or until it is removed from the cue list using filters or null commands.

Secondly, tracking relates to how changes to cue data are handled. Unless otherwise instructed by a Cue Only command, changes to a parameter in a cue will track forward through the cue list until a move instruction (or block command) is encountered.

It is possible to change the default setting of Ion to "Cue Only". This prevents changes from tracking forward into subsequent cues, unless overridden with a track instruction.

Ion also has a **[Cue Only/Track]** button that allows you to record or update a cue as an exception to the default setting. Therefore, if the console is set to Tracking, the button acts as Cue Only. If console is set to Cue Only, it behaves as a Track button.

Move Fade

Move Fade is a lighting control philosophy which determines how cues are played back. Ion adheres to this philosophy.

In a Move Fade system, parameters do not change from their current setting until they are provided a move instruction in a cue or are given a new instruction manually.

For example, in cue 1, channel 1 has been given an intensity value of 50%. This value does not change until cue 20, where channel 1 is moved to 100%. Therefore, channel 1 has a tracked intensity value of 50% in cues 2-19. If the user applies a manual intensity value of 25% while sitting in cue 5 (for example), that channel will stay at 25% until Cue 20 is recalled - because 20 is the next cue in which channel 1 has a move instruction. The original intensity of 50% will not be reapplied in subsequent cues unless specifically called out by the cue or manually performed.

Cue List Ownership

Ion is capable of running multiple cue lists. In a multiple-cue-list console, cue list ownership is an important concept. Cue list ownership is determined by the cue from which a channel is currently receiving its value. In Live, a parameter is considered to be “owned” by a cue list when it is receiving its current value from that cue list.

When alternating between cue lists in sequential playback, an active cue list does not necessarily own a channel unless that list has provided the last move instruction for that channel. For example, assume a channel is owned by cue list 1 and is at a tracked value. If a cue from another cue list is executed and provides a move instruction for the channel in the new cue, the channel is now owned by the second cue list. It will not return to cue list 1 until that cue list provides a move instruction for the channel.

Assert may be used to override this default behavior, allowing a cue list’s control over a channel to resume, even when the channel’s data is tracked.

This rule is not followed when executing an out-of-sequence cue. An out-of-sequence cue is any cue that is recalled via “Go To Cue”, a Link instruction, or manually changing the pending cue. In general applications, the entire contents of the cue (both moves and tracks) will be asserted on an out-of-sequence cue.

Block vs. Assert

In previous ETC consoles, placing a block instruction on a channel was a way to treat a tracked value as a move instruction, both in editing and playback. In Ion, this behavior is now split up. Blocked channel data is an editing convention only, and it prohibits tracked instructions from modifying the associated data. Blocked data has no impact on playback; the channels will continue to play back as though they were tracks. Assert is used to force playback of a tracked/blocked value.

Live and Blind

Live and Blind are methods to view and edit data in your show files. When you press the **[Live]** key, the screen will show you the live display. When you press **[Blind]**, you will see the blind display. In either case, you may use the **[Format]** key to alter how the data is displayed (see [Using \[Format\], page 39](#)).

When in Live, the data displayed represents the data being sent from the console at that moment. In other words, the parameter data that is “live” on stage. When you edit data in live, those changes will become active and visible on stage as soon as the command line is terminated.

When in Blind, the data displayed represents data from the record target you choose to view (cues, presets, palettes, and so on). When you edit data in Blind, changes will not automatically appear on stage, since the data you are modifying is not live. This is true even if the record target you are modifying is active on stage. It is possible to play a cue in Live, then switch to Blind and edit that cue in blind without affecting levels on stage. Edits in Blind do not require a **[Record]** command to be stored. They are considered stored when the command line is terminated. Any display that is not the Live display is considered Blind, and the Blind LED will be illuminated. For example, if you open patch, the blue LED on **[Blind]** will be lit to show that you are in a Blind display.

HTP vs. LTP

HTP (Highest-Takes-Precedence) and LTP (Latest-Takes-Precedence) are terms used to define the output of a channel parameter that is receiving data from multiple sources. In HTP, the highest level of all sources will be executed. In LTP, the most recent level received will be executed. Cue lists and submasters can operate as HTP or LTP for intensity parameters only. Non-intensity parameters (NPs) are always LTP. Submasters can operate as HTP or LTP for intensity. The default is HTP. Ion’s default cue list setting for intensity is LTP (see [HTP/LTP, page 209](#)). Ion’s default submaster setting for intensity is HTP.

HTP

HTP is only applicable to the intensity of a channel. HTP channels will output the level that is the highest of all inputs. HTP channels are also referred to as “pile-on”, because as control inputs are added (for example - you may bring up cues and multiple submasters that all have the same channel recorded at various levels), the system calculates which input has the highest level for that channel and outputs that level for the channel. As control inputs are removed (you pull some of the submasters down to zero), the console will adjust the channel level, if required, to the highest remaining level.

LTP

LTP is applicable to any parameter of any channel. LTP output is based on the most recent move instruction issued to the channel parameter. Any new values sent to the channel will supersede any previous values, regardless of the level supplied.

Ion determines the LTP value for a channel, which is overridden by any HTP input values that are higher than the LTP instruction. This is then finally modified by manual control.

Other Reference Materials

Help System

A keyhelp system is also contained within your system. To access help, press and hold **[Help]** and press any key to see:

- the name of the key
- a description of what the key enables you to do
- syntax examples for using the key (if applicable)



Note:

Keyhelp is included on most tangible action buttons on your Ion console. This includes most softkeys and clickable buttons as well as the traditional keys on the keypad.

*As with hard keys, the “press and hold **[Help]**” action can be also used with softkeys and clickable buttons.*

Online Eos Family (Eos Ti, Eos, Gio and Ion) User Forums

You are encouraged to visit and participate in the ETC Eos Family (Eos Ti, Eos, Gio and Ion) User Forum, accessible from the ETC web site (www.etcconnect.com). This gives you access to an online community of Eos, Eos Ti, Gio, and Ion users where you can read about other users' experiences, suggestions, and questions regarding the product as well as submit your own.

To register for the ETC Family (Eos Ti, Eos, Gio and Ion) User Forum:

- Step 1: Go to ETC's community web site (www.etcconnect.com/community). An introduction page to the online community will open.
- Step 2: You may register for the forum using the “**register**” link in the introduction or by clicking the “**join**” link in the upper right corner of the page.
- Step 3: Follow the registration instructions provided by the community page.

Chapter 1

System Overview

Inside this chapter you will find general descriptions of your Ion control console, how it fits into a network control system, and the various areas of user interface.

This chapter contains the following sections:

- **System Components**10
- **Console Geography**12
- **Cleaning Ion**14
- **Outputting DMX**14
- **Console Capacities**15

System Components

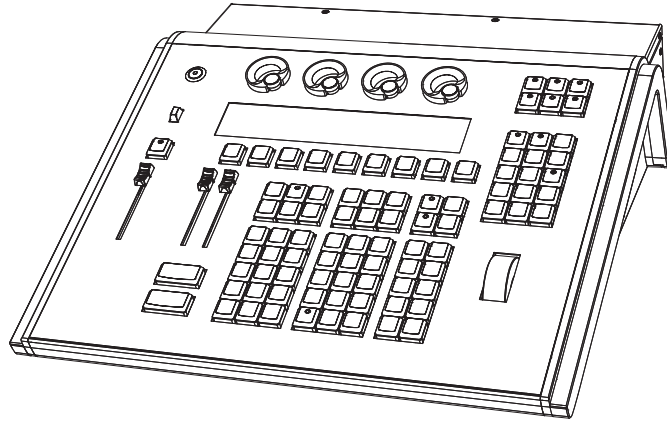

Console

Ion is designed from conception as a fully integrated controller for conventional lights and multi-parameter devices (for example: moving lights, LEDs, color scrollers, gobo wheels). Attention to detail across all areas of the system design and architecture allows you the utmost flexibility and customization of use.

Ion allows designers and programmers to develop a mutual vocabulary for control. This implementation of simple and uniform syntax for control provides a solid foundation for both experienced and inexperienced users.

Remote Processor Unit (RPU)

The RPU can be used as the primary, backup processor for the system, a client, or for primary playback in installations that do not require a facepanel after initial programming is completed.

For more information, see the appendix [Remote Processor Unit \(RPU\)](#), page 383.

Remote Video Interface (RVI)

The remote video interface allows remote interaction with the lighting control system. This can be for display purposes only. Additionally, with a mouse and alphanumeric keyboard attached, the RVI can be used as a remote programming station. The RVI provides supports for a maximum of two DVI or SVGA monitors, 1280x1024 minimum resolution.

For more information, see the appendix [Remote Video Interface \(RVI\)](#), page 379.

Radio Focus Remote (RFR)

The RFR provides wireless control of key front panel functions. The base station for the RFR can be networked into the system, or can connect to a console or remote device using the USB interface.

For more information, see the appendix [Remote Control](#), page 377.

iRFR and aRFR

The iRFR and aRFR provide wireless control of key front panel functions. [See "iRFR" on page 388.](#) [See "aRFR" on page 388.](#)

Gateways

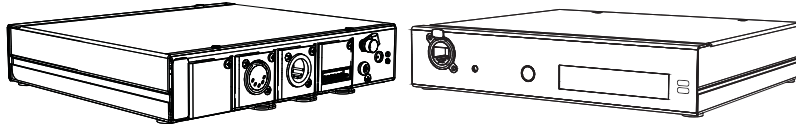

Ion is part of a fully networked system capable of direct output of both ETCNet2 and Net3. Gateways can be configured to listen to either ETCNet2 or Net3 and provide interface to devices in the lighting system that do not accept network communication directly. Gateways are provided for DMX/RDM output, show control input and output and analog input and output.

- Net3 to DMX/RDM gateways are provided with a maximum of four outputs, which can be male, female, or terminal strip.



Note: *Net3 Gateways only support RDM when in Net3 mode.*

- Show Control Gateway supports MIDI In/Thru and Out and SMPTE In.
- I/O Gateway supports 24 analog inputs, 16 SPDT contact closure outputs, and RS-232 serial protocol.

Console Geography

Below is a diagram of the Ion console with references made to specific areas of use. The terms and names for each area and interface are used throughout this manual.

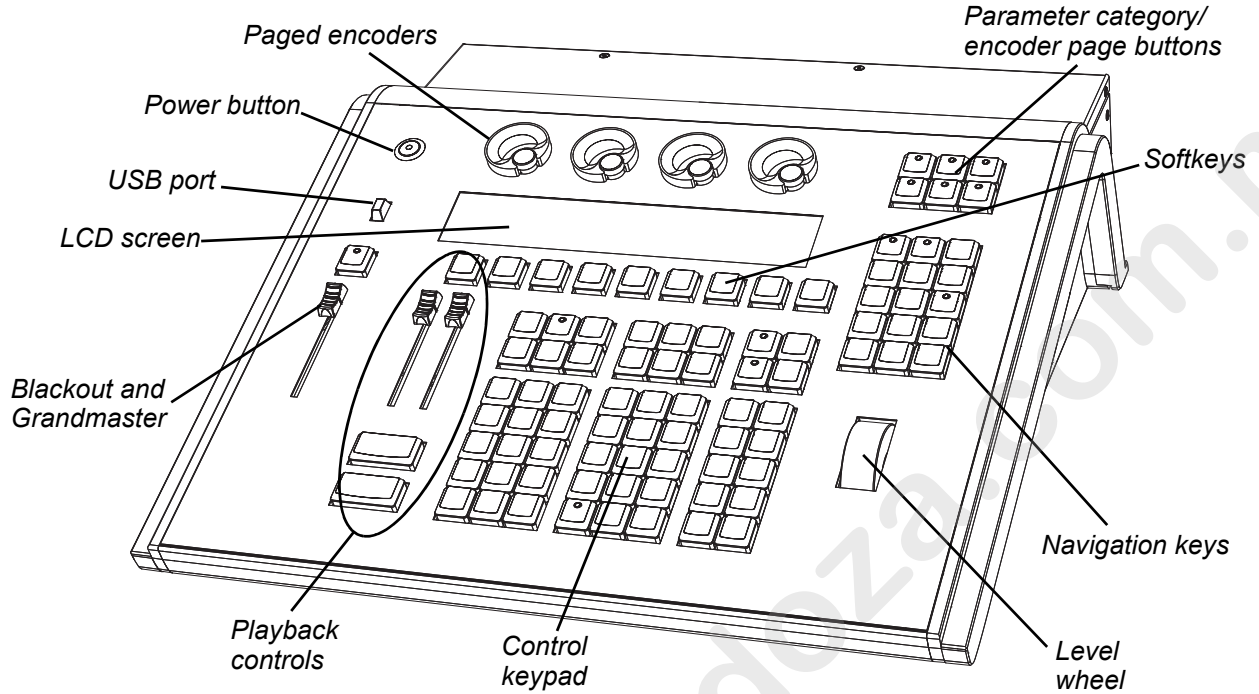

Current Ion Rear panel

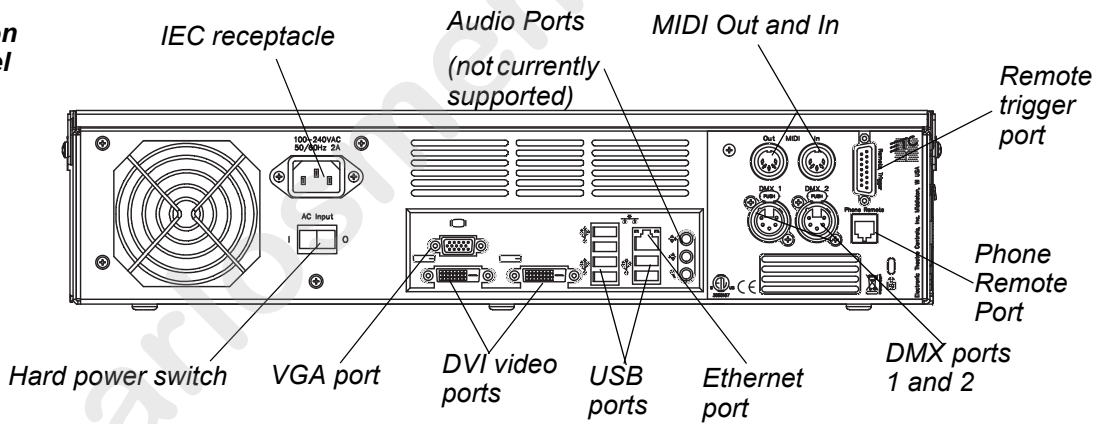

Original Ion Rear panel

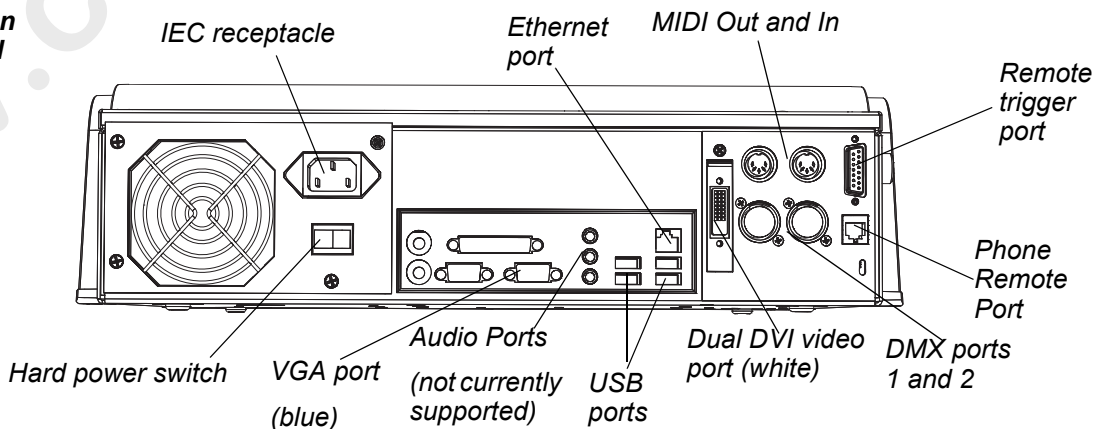

Terminology

Power Button

The power button on the front of the console is used to power up or power down. A separate power switch, located in the rear panel, can be used to disconnect power from the console's internal components.



WARNING: *Before servicing Ion, you must switch off the power on the rear panel and disconnect the power cord completely.*

USB Ports

One USB port is provided on the front of the console to connect any USB storage device. An additional USB ports on the rear panel can be used to connect peripherals such as an alphanumeric keyboard, pointing device, or touchscreen control for external monitors.



CAUTION: *The USB ports cannot be used for charging devices such as cell phones.*

Encoders

Encoders and the LCD (see below) for control of non-intensity parameters are provided at the top center of the console. The four encoders are pageable controls, which are populated on the LCD with the parameters used in your show.

LCD

This display accompanies the CIA as an additional user interface. This LCD offers you softkeys, encoder information, and an additional view of the command line.

Load

The load button is located above the fader pair at the bottom of the LCD and is used to load the specified cue.

Control Keypad

The control keypad area is divided into three general sections including record targets, numeric keypad and modifiers, and special function controls.

Level Wheel

Adjusts intensity for selected channels. It also provides scrolling and zoom functions in various modes.

Navigation Keypad

Used for quick access to the live and blind displays, format, paging, and navigation within displays.

Parameter Category/ Encoder Page Buttons

Parameter buttons are used to select parameter categories and change encoder pages. To post a parameter category to the command line, use **[Shift] & [Encoder Page Button]**.

IEEE Ethernet 802.3 Ethernet Port

Ethernet port for connection to a network switch, network gateways, and accessory devices.

Littlites®

You may connect a Littlite to the side of your Ion console.

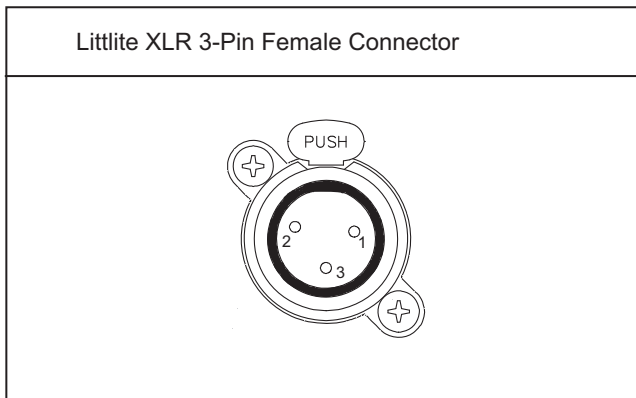

Dimming Littlites

Attached desk lamps can be dimmed either with the desk lamp control knob on the side of the console, or from the software.

Desk lamp controls are found in **Setup>Desk>Brightness Settings**. The **{Desk Lamp}** slider has a range of 0% (dimmiest) to 100% (brightest). The default setting is 0%. The console will set the desk lamp to this setting on startup of the application. See “[{Brightness Settings}](#)” on page 108.

The desk lamps can also be controlled by holding down **[Displays]** and rolling the level wheel.

Cleaning Ion

Should the exterior or LCD of your Ion require cleaning, you may gently wipe them with a dampened (**not dripping**), non-abrasive paper towel or soft cloth.

If this does not clean the console sufficiently, you may apply some window cleaner (containing ammonia is fine) to the cloth and repeat the process until clean.

Outputting DMX

In order to output levels from Ion, you can either use the DMX ports on the back of the console, or to output over a network, you may connect a Net3 gateway or Net2 node. If your devices receive Net3 or ETCNet2 directly, no gateway or node is required.

Ion has two DMX ports. To output, connect one 5 pin XLR cable per port. The first port will default to outputting the first universe of DMX, addresses 1-512, and the second port to the second universe, outputting addresses 513-1024. See [Local DMX Outputs, page 351](#) for information on reconfiguring the DMX ports.

Nodes and gateways will function with Ion out of the box without previous configuration. However if custom configuration is required, you will need to use either NCE (Network Configuration Editor) or GCE (Gateway Configuration Editor). GCE is installed on Ion by default and can be accessed in **ECU>Settings>Maintenance>Gateway Configuration Editor (GCE)**. NCE can be installed on the console or a Windows® PC for configuration.

For more information on Net3 gateways or Net2 nodes, see the product literature that accompanied the hardware or download it from our website at www.etcconnect.com.

Console Capacities

Output Parameters

- 1,024 outputs (DMX channels)
-or-
- 1,536 outputs (DMX channels)
-or-
- 2,048 outputs (DMX channels)
-or-
- 3,072 outputs (DMX channels)

Channel Counts

- 10,000 channels (any number from 1 to 99,999)

Cues and Cue Lists

- Up to 999 cue lists
- Up to 10,000 cues

Record Targets

- 1,000 Groups
- 1,000 x 4 Palettes (Intensity, Focus, Color and Beam)
- 1,000 Presets
- 1,000 Effects
- 1,000 Macros

Faders

- 1 dedicated Master Playback, with Go and Stop/Back
 - a maximum of 200 configurable playbacks, with Go and Stop/Back
 - a maximum of 300 configurable submasters, with Bump and Assert/Select

www.carlosmendoza.com.mx

Chapter 2

System Basics

This chapter explains the base level procedures for setting up, navigating, and understanding how to operate Ion.

This chapter contains the following sections:

- **Setting Up the Hardware**18
- **Power**19
- **Your First Interaction**20
- **The Central Information Area (CIA)**22
- **Using the Browser**24
- **Display Control and Navigation**28
- **Graphical User Interface (GUI) Display Conventions**31
- **Using [Format]**39
- **Using Flexichannel**36
- **Encoders**45
- **Moving Light Controls**46
- **Using Softkeys**47

Setting Up the Hardware

Follow these steps to prepare your Ion for use.

- Step 1: Place your console on a firm, level surface. Be sure to leave space for access to the rear of the console. You will need to connect several items to the ports on the back.
- Step 2: Connect any monitors to the proper ports on the back of the console.



Note: *Ion supports up to 2 monitors, either 2 DVI -D monitors or 1 DVI-D and 1 VGA.*

- Step 3: Connect the keyboard and mouse. Attach to the appropriate connector on the back of the console.
- Step 4: If you will be connecting to an Eos Family network, connect the appropriate Ethernet (CAT 5 or better) cable to the Ethernet port on the back of the console.
- Step 5: If you plan on using the DMX ports on the back of Ion to control your lighting system, attach the appropriate DMX connector and cable to the desired port. These ports default to output DMX universes one and two. Configuration is required to use any other universe. For more information, see [Local DMX Outputs, page 351](#) in the ECU appendix.
- Step 6: Attach the appropriate IEC power cable for your location to the IEC connector on the back of the console, just above the power switch.

Your console hardware is now ready to be powered up.

Power

Power Up the Console

- Step 1: Attach the appropriate power cable to the IEC connector on the rear of the console.
- Step 2: Press the I/O switch (I is “on”) next to the IEC connector on the rear of the console to turn power on. This will provide power to all internal electronics.



Note: *You need to wait about 30 seconds between steps 2 and 3.*

- Step 3: Press the power button, located in the top left corner of the console, above the USB port. The button LED will illuminate blue to indicate the console is running. The console will boot up into the Ion environment. The Ion system is now ready for use.



Note: *In the future, you may go straight to the welcome screen by adjusting a setting in the ECU. See [Open in Shell, page 337](#) in the ECU appendix.*

Power Down the Console

- Step 1: After saving your show (see below), in the browser menu select **Power Off Device**. A dialogue box opens asking you to confirm.
 - Step 2: Confirm this command by clicking **{OK}** in the dialog box. The console will power down.
- Or-
- Step 1: Press the power button, located on the face panel. A dialogue box opens asking you to confirm.
 - Step 2: Confirm this command by pressing **{OK}** in the dialog box or by pressing the power button again. The console will power down.



Note: *Ion is a persistent storage console. Therefore if you shut down your system without saving the show file, you will return to the same place in your show when you reboot.*



Note: *The console will display an improper shutdown message on the next power up if the console was not powered down from the browser menu or welcome screen.*

Your First Interaction

When you first start up Ion, you will immediately enter the Ion software environment.

Since Ion can be set up with one or two monitors, what you will first see depends partly upon the number of monitors you are using.

Single Monitor Configuration

When using a single monitor, the top half of the initial display screen becomes the primary viewing area for displayed information. Ion will first open with the live table display on the top (primary) half of the screen and the CIA on the bottom half of the screen.

When the CIA is open, one line of the playback status display is visible above the double arrows. You can view more of the playback status display by collapsing the CIA (see [Collapse/Expand the CIA, page 22](#)).



Initial View - Primary/CIA

Dual Monitor Configuration

When two monitors are used, one monitor will default to showing the CIA, and the other will default to having the live display and the playback status display open on tabs.

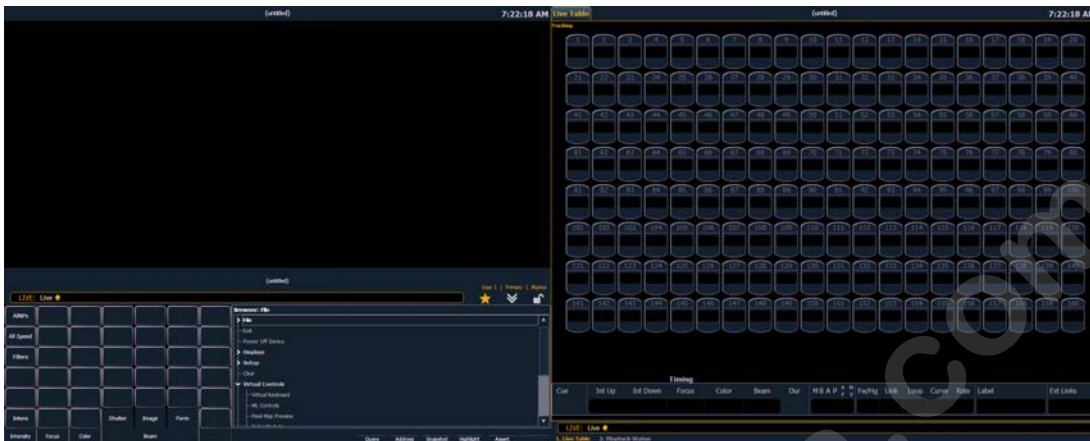

For additional information on displays, see [Display Control and Navigation, page 28](#).

Please see [Monitor Arrangement, page 338](#) for more information on configuring Ion for a dual monitor configuration.

The Central Information Area (CIA)

The Central Information Area (CIA) is displayed on the lower portion of the screen. By default, the CIA consists of two primary areas: the parameter display and the browser.

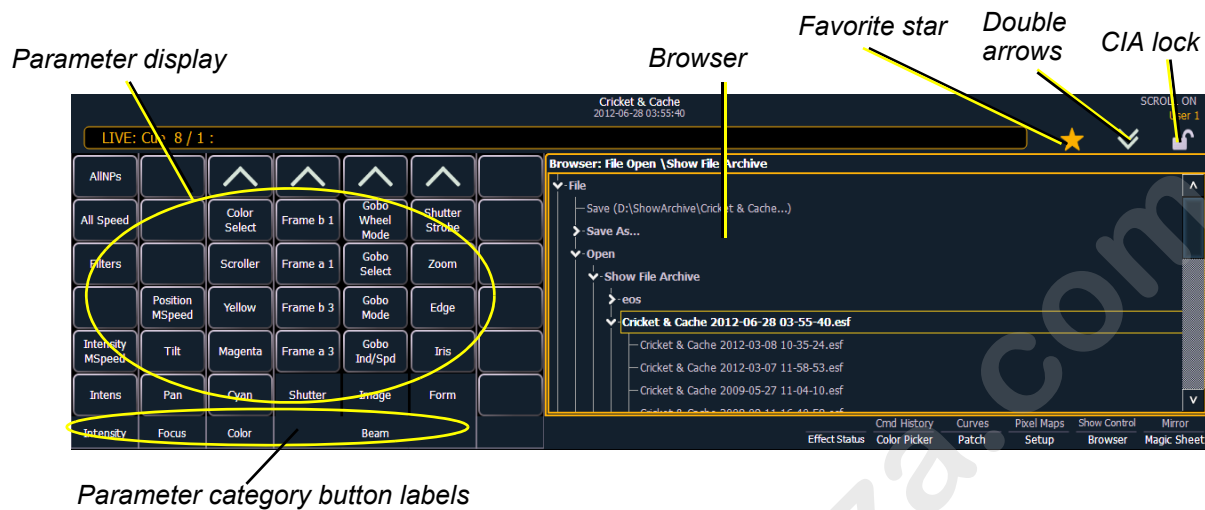

Parameter Display

This display shows the parameters available for patched channels. It is also where you can select which parameters to view in live or blind, or select parameters for command line control. The parameter display will dynamically change depending on the channel (fixture) selected and its applicable parameters.

Browser

The browser is the interface for numerous functions including saving a show, opening a show, changing settings, viewing record target lists, opening displays and many other functions.

Collapse/Expand the CIA

It is possible to collapse the CIA from view. To do this, you can click the **double arrow** icon centered above the CIA. The CIA will collapse from view, exposing a larger viewing area of whatever display is visible above the CIA. The double arrows will move to the bottom of the screen.

To expand the CIA into view again, click the **double arrow** at the bottom of the screen. The CIA will reopen.

Lock the CIA

You can lock the CIA in place to prevent it from being collapsed.

To lock the CIA, click on the **lock** above the browser. The double arrow above the CIA will disappear and the lock will “lock”.

To unlock the CIA, click the sunken **lock** again and the double arrows will reappear.

Favorite CIA Display

You can select a favorite default display for the CIA that will show when **[Displays]** is pressed. The standard default display for the CIA is the Browser.



The favorite display will show a gold star icon at the top of the CIA by the double arrows & lock. Displays that can be selected as a favorite, but are currently not, will show a grey star at the top of the CIA. Click on the grey star to make that display your favorite. That display will now be the new default display for the CIA. Displays that show up in the CIA but can not be the default display will not show the star icon.

The following displays can be set as the favorite CIA default:

- About
- Browser (default)
- Color Picker
- Direct Selects
- Virtual Sliders
- Virtual Keypad
- ML Controls
- Encoder Information Screen
- Effects Status

Locking the Facepanel

It is possible to lock out the facepanel, which prevents any actions from the command line or CIA. To lock out the facepanel, press **[Shift] & [Escape]**. To unlock the facepanel, press **[Shift] & [Escape]** again.



Note: *This will also lock any fader wings or USB connected peripherals.*

Using the Browser

To use the browser, you must first draw focus to it by clicking anywhere in the browser area of the CIA or by pressing the **[Displays]** key. If the browser is not visible, double pressing **[Displays]>Browser** will always bring up the browser.

When focus is on the browser, the window border highlights in gold. The scroll lock LED illuminates red and the paging keys will now control selection in the browser.

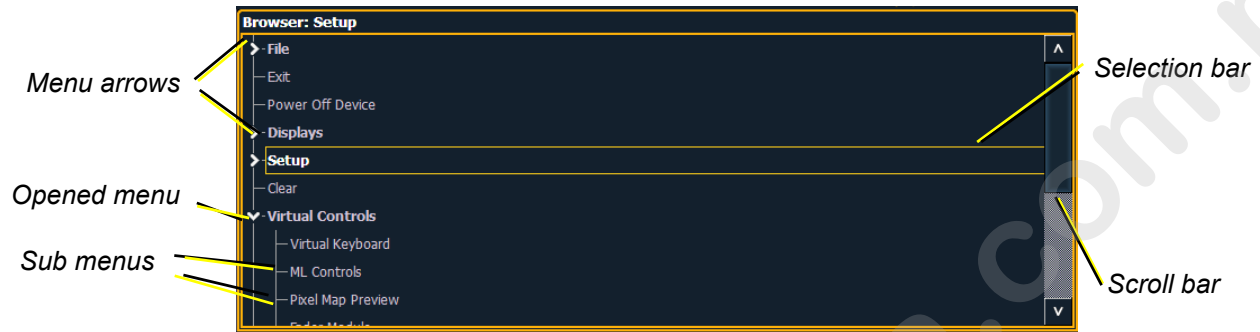

- Use the page arrow keys to move the selection bar up and down the list. You can also use the level wheel to scroll through the list.
- When the bar highlights the desired menu, press **[Page ▶]** to open the menu.
- Continue pressing **[Page ▶]** to open submenus.
- Scroll to the item you wish to open using **[Page ▲]** or **[Page ▼]** and then press **[Select]**. You may also click the item you wish to open and then press **[Select]**. You can also use the level wheel to scroll in the browser.
- If you wish to close a submenu scroll to that item and press **[Page ◀]**.
- To draw focus to the CIA press the **[Displays]** key.
- Additional presses of **[Displays]** will minimize or restore the CIA.



Note: The **[Select]** key can be used to confirm a choice in the browser.

Virtual Keyboard

It is possible to open a virtual keyboard in the CIA which mimics the hard keys found on the actual Eos keypad. The keypad will not match the facepanel on Ion. This virtual keyboard is accessible from the browser.

To open the Virtual Keyboard on a monitor:

- Step 1: Go to **Browser>Virtual Controls>Virtual Keyboard**. A window will open in the CIA displaying your monitor placement options for the keyboard.
- Step 2: Click the placement option in which you want the keyboard to appear.

To close the Virtual Keyboard on a monitor:

- Step 1: Go to **Browser>Virtual Controls>Close Module**. The placement screen will appear again in the CIA.
- Step 2: Click the placement of the module you wish to close. The module will be removed.

Fader Module

If you prefer to have faders available to you, the monitors can be populated with virtual faders, called fader modules.

To open the fader module on a monitor:

- Step 1: Go to **Browser>Virtual Controls>Fader Module**. A window will open in the CIA displaying your monitor placement options for the module.
- Step 2: Click the placement option in the CIA in which you want the module to appear.

To close the fader module on a monitor:

- Step 1: Go to **Browser>Virtual Controls>Close Module**. The placement screen will appear again in the CIA.
- Step 2: Click the placement of the module you wish to close. The module will be removed.

Using Direct Selects

Direct selects allow access to a number of controls, including a channel select display. If there are more items than can be viewed at once, you may view subsequent pages by using the page buttons (**{Page ▲}**, **{Page ▼}**) by the direct selects.

Selecting Channels with Direct Selects

Channel direct selects are highlighted when selected. Channel selection is generally an additive process, if channels 1-5 are selected, pressing **{Channel 6}** adds channel 6 to the selection, leaving channels 1-5 also selected. Pressing **{Channel 6}** again will deselect the channel.

If you have labeled channels in patch, those labels will be displayed above the channel number when viewing channels in the direct selects.

It is possible to double hit a channel button. This selects that channel and deselects any previously selected channels.

- **{Channel 1}** - adds channel 1 to currently selected channels, if not currently selected.
- **{Channel 1} {Channel 10}** - adds channels 1 and 10 to currently selected channels.
- **{Channel 1} {Channel 1}** - selects channel 1, deselects all other channels.
- **{Page ▼}** - pages direct selects down by one page.
- **{Page ▲}** - pages direct selects up by one page.

Direct Selects

Ion gives you the option of opening direct select modules on the monitors.

To open the direct selects on a monitor:

- Step 1: Go to **Browser>Virtual Controls>5 x 10 Direct Select Module**. A window will open in the CIA displaying your monitor placement options for the module.
- Step 2: Click the placement option in which you want the module to appear.

To close the direct selects on a monitor:

- Step 1: Go to **Browser>Virtual Controls>Close Module**. The placement screen will appear again in the CIA.
- Step 2: Click the placement of the module you wish to close. The module will be removed.

For information on populating direct selects see [Organizing the Direct Selects](#).

Organizing the Direct Selects

You have considerable flexibility in how you organize the direct selects. They may be arranged to display one of several different types of data.

To choose which information to view:

- Step 1: Click the **{Select}** button for any block of direct selects. You will be offered the following choices to view: Channels, Groups, Intensity Palettes, Focus Palettes, Color Palettes, Beam Palettes, Presets, Macros, Effects, and Snapshot.
- Step 2: Click the button for the data you wish to view and the associated direct selects will populate with any recorded information of that type. If there is no recorded information of that type the block of buttons will remain empty but will populate with data of that type as associated record targets are stored.
- Step 3: You may also click **{Select}** again, without choosing any option, to return to the previous state.

You can increase/decrease the size of any set of direct selects by pressing the **{20/50}** button, which will change the display between one set of 50 buttons and two sets of 20 buttons. Or you may press the **{100}** button to expand to a full set of 100 buttons. Press **{100}** again to switch back to the previous view.

You may also press the **{Expand}** button (located beneath the **{Select}** button) to expand a set of direct selects to full screen. Press **{Expand}** again to return the set to its previous size and mapping. Century and Millennium buttons will display when direct selects are in expand mode.

When the direct selects are opened on a tab, two sets of direct selects will be displayed.

Direct Selects in Flexi Mode

Direct selects can be placed into a flexi mode, which will remove empty tiles. When **{Select}** is pressed, the **{Show Flexi}** button will display.

On



Off

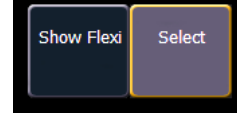

Note:

A single empty direct select tile may remain if the adjacent direct select tiles are not sequential. This is to allow an easy way to insert a new direct select between the existing ones.



Show Flexi is Off



Show Flexi is On

Clear Functions

You can access the various clear options from the browser by selecting **{Clear}** from the main browser menu. The clear functions window will open in the CIA.

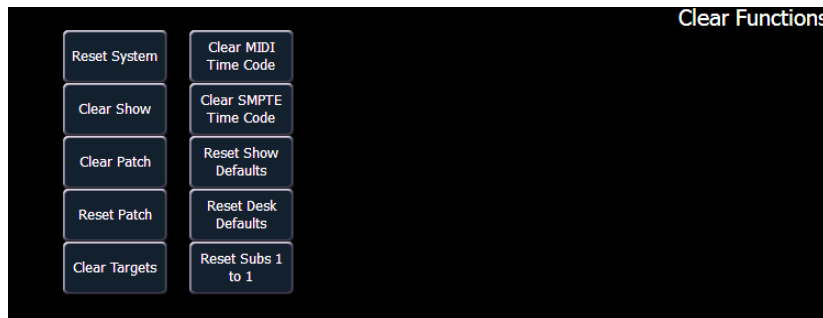

From this menu you can select one of the available clear options by clicking on the desired button in the CIA. Ion will ask you for a confirmation before performing the selected clear. For **{Clear Targets}**, Ion will allow you to choose which record targets you want to clear.



From the **{Clear Targets}** screen you can select which record targets you wish to clear. The buttons at the center of the CIA represent all of the record targets that you can choose to clear. By default all components are selected (gray) and will be cleared. To withhold any targets from being cleared, simply deselect them in the CIA by clicking the respective button.

To reselect all targets, click the **{Reset}** button and all buttons will return to gray (selected). To stop the process, click the **{Cancel}** button.

When you have selected or deselected all of the record targets you require, click **{OK}**.

After clearing, the CIA will return to the browser. If you want to perform additional clear functions, you must select **{Clear}** from the browser again.

To exit the clear functions screen without clearing, press the **[Displays]** key at any time or select a clear button and then select **{Cancel}** from the confirmation screen.

Reset System vs Clear Show

Using **{Reset System}** will open a new show file and reset the Setup options to their defaults. Using **{Clear Show}** will only open a new show file.

Reset Patch vs Clear Patch

Using **{Reset Patch}** will clear your patch and set it to a 1-to-1 patch. Using **{Clear Patch}** will only clear out the patch.

Display Control and Navigation

Opening and Closing Displays

The live/ blind display will always open as tab 1. The playback status display will always open as tab 2. Neither of these displays can be closed.

Other displays are numbered as they are opened. Tab numbering is useful for navigating to views.

Displays can be opened and closed in different ways, depending on the display. Many displays are accessible from the browser, while other displays are accessible from the LCD softkeys. The blind displays of record targets (also called “lists”) can be quickly accessed by double pressing the record target button (for example, **[Preset] [Preset]** opens the preset list).

From the browser

Open and navigate the browser as described in [Using the Browser, page 24](#). When you open a new display (such as the cue list index, group list, or patch) and it is posted in a tab view, it will open on monitor 2. If the display does not open as a tab view (such as “setup” or the browser) it will open in the CIA.

Again, any time you wish to return to the browser, simply press **[Displays]** and then **{Browser}** and it will be made available.

From the hardkeys

You can open list views of any record target by double-pressing the key for the desired record target.

From the LCD softkeys

To open any displays accessible from the softkeys, press **[Displays]**. The softkeys will repaint to display:

- Effect Status
- Color Picker
- Patch
- Setup
- Browser
- Magic Sheet
- Command History
- Curves
- Pixel Maps
- Show Control
- Mirror

Any of these softkeys will open the associated display with a single press.

Closing Displays

To close any tab display, select the display by using the **[Tab]** key or other means of navigation. When the desired display is active, press **[Escape]** to close it.

To close a display in the CIA, press the **[Display]** key and the browser will reappear.

To close all displays except for the live/blind display and the playback status display (tabs 1 and 2), press **[Shift] & [Tab]**.

Selecting Displays

When a display is selected, the screen is highlighted in a gold border and the display name (such as “1. Live Channel”) will be in gold as well. When a display is not selected, there is no border and the tab name is gray.

If a display is already open, it can be selected in the following ways:

- Press **[Tab]** to change focus from the currently selected tab to the tab immediately to the right. If no tabs are to the right, the selection moves to the first tab on the left of all available monitors.
- Press **[Tab] & [n]**, where “n” represents the tab number of the desired tab.
- Press **[Live]** or **[Blind]** to automatically bring live/blind into focus. If there are multiple instances of live/blind, pressing **[Shift] + [Live] / [Blind]** brings the next live/blind tab into focus.
- Double press a record target button (such as **[Preset]** or **[Submaster]**) to either open the associated display or select it if it is already open.

Moving Displays

To move the active display from one monitor to another, press and hold the **[Tab]** key and use the page arrow keys to move the display in the direction of the desired screen. One press of the left or right page keys will move the display to the next screen in that direction. To move it back, press the opposite arrow key.

Scrolling within a Display

By default the page keys will advance/retreat a display by one page per press. However, to scroll through displays you may press the **[Scroll Lock]** key on the keypad. The LED on the button illuminates red when in scroll lock mode.

Scroll lock is a toggle state. When scroll lock is first pressed:

- **[Page ▼]** - scrolls table, spreadsheet and channel views down,
- **[Page ▲]** - scrolls table, spreadsheet and channel views up,
- **[Page ►]** - scrolls table and spreadsheet views right,
- **[Page ◀]** - scrolls table and spreadsheet views left.

Expanding Displays

[Expand] allows a tab to be viewed across multiple external monitors.

To expand a display to an adjacent monitor, press **[Expand] & [Page ►]** if in table views or **[Expand] & [Page ▼]** if in either view.

To collapse an expanded view, press **[Expand] & [Page ◀]** if in table views or **[Expand] & [Page ▲]** if in summary views.



Note:

*Please note that you must have two monitors attached to Ion to use the **[Expand]** feature.*

If the display you are expanding is at the right most position, the display will expand onto the first (or left most) monitor.

Zooming Displays

You may zoom in and out on displays. To do this, press and hold the **[Format]** button and scroll the **Level Wheel** to alter the display. Scrolling the wheel up zooms in. Scrolling the wheel down zooms out. Zooming the channel summary display when it is in 100 channel mode is not supported. You can also zoom by holding down the left mouse button and rolling the scroll wheel on a mouse.

Graphical User Interface (GUI) Display Conventions

Ion relies on many traditional ETC indicators which you may be familiar with, as well as some new ones. This section identifies the graphical and colorful conventions used in Ion to indicate conditions to you.

Indicators in the Live/Blind Display

This is the live/blind summary view.



Note: The color and text conventions described below apply regardless of the format of live/blind being used (see [Using \[Format\], page 39](#)).

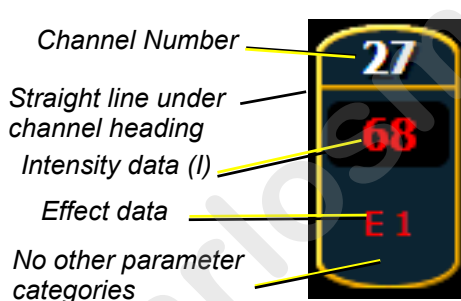

Conventionals

Most of the channels in the above image are conventional channels (intensity is the only available parameter).

Conventionals have a straight line beneath the channel number. They also display only the top field, intensity, as no other parameters are available on a conventional channel.

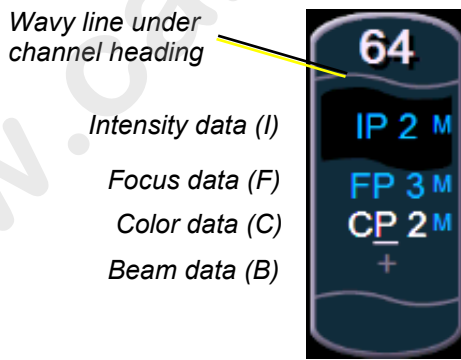

Moving Lights or Multi-parameter Devices

Several channels in the image are moving lights (possessing more parameters than just intensity).

Moving light channels have a wavy line beneath the channel number as well as parameter category indicators at the bottom of the channel.

This view also has additional data fields beneath intensity (F, C, B). This information can be suppressed by pressing and holding **[Data]** and any of the encoder paging keys (Focus, Color, Image, Shutter, or Form). Doing so will leave only the intensity field and FCB indicators at the bottom of the channel.

F, C, B icons when collapsed



Color indicators

Ion uses color to indicate the selection state and information about channel or parameter levels.

Channel numbers/channel headers



Selected Unselected Unpatched Deleted

- **Gray number** Unpatched channel number.
- **White number** Selected channel number.
- **Bright White number** . . Channel is parked.
- **Gold number** Channel is captured.
- **Gold outline** Selected channel.
- **Number with no graphic** Deleted channel.

Channel or parameter levels

- **Bright Red** Manual Data (any data that has been set but not yet stored to an active cue or submaster) on all consoles using the same user ID.
- **Dark Red** Manual Data (any data that has been set but not yet stored to an active cue or submaster) from other consoles that are using different user IDs. *Different User ID*
- **Blue** The intensity value is higher than in the previous cue. Non-intensity parameters (NPs) are in blue when any move instruction has occurred. Unmarked.
- **Green** The intensity value is lower than in the previous cue. Also used in reference marking to indicate a channel is marked.
- **Magenta** Value is unchanged from the previous cue (tracked).
- **White** The value is blocked.
- **White with an underscore** Value is auto-blocked.
- **Gray** Default or the value is a null value (from either **{Make Null}** or a filter). When nulled, a gray “n” appears next to the value.
- **Yellow** Data set from a submaster.



Note:

When data is in transition (moving), it will appear in a lighter version of its color. This includes up/down fades for intensity, non-intensity moves from cues, submaster, and timed manual changes.

- **MK** Indicates the channel is marked for a later cue. The cue number is indicated in the other categories (see “Q” below).
- **N** Indicates the value is null (from either **{Make Null}** or a filter).
- **P** Indicates the channel is parked.
- **Ph** Indicates the channel is at a preheat level.
- **Pr** Indicates that the value is referenced to a preset. This text is followed by a number, indicating which preset is being referenced. The preset label may also be shown if this setting is enabled (see [Show Reference Labels, page 107](#)). Holding down **[Shift] & [Label]** will toggle between the preset label and preset number.
- **Q** Found in the non-intensity categories of a marked channel. The “Q” is followed by a number indicating which cue the mark is in preparation for.
- **t** The channel has discrete (parameter/category-specific) timing.
- **+** Found in place of parameter data in summary view. Indicates that not all parameters in that category are at the same value. This indicator is found only in the summary view or in table views when the parameters are collapsed into a category view.
- **!** Indicates an ACN, RDM, or dimmer error.
- **ND** Indicates that a channel has been patched as a non-dim fixture type.
- **S** Indicates that a channel is stored to a shielded submaster.
- **R** Indicates a manual reference override. Manual changes have been made that override a previously stored reference (such as to a palette or preset). Once recorded, the reference will be broken. If updated, the referenced target will be updated as well, unless otherwise instructed.
- **M** Indicates a mark is placed, but manual, and must be stored. Is blue when stored. “m” indicates cue is not marking.

[Data] Key

Pressing and holding **[Data]** allows you to view the values behind any referenced or marked data. **[Data]** exposes the next lower reference level. So if you view a palette reference and press **[Data]**, the absolute data will be displayed instead. If you are viewing a preset, absolute or palette data will be displayed, depending on what is contained in the preset.

The **[Data]** key is also used in combination with the encoder paging keys to change the level of detail in summary and views, and to select parameters to view in spreadsheet modes.

[Time] Key

Pressing **[Shift] & [Time]** allows you to view discrete timing data behind any channel parameter. Keep **[Time]** held down to page. **[Time]** exposes channel or parameter specific timing for any channels in the current cue. The first value is the delay time. If "--" is displayed, there is no delay. The value to the right of the / is the transition time.

When the **[Time]** button is pressed on a terminated command line, the selected cue is always displayed for time modification. To add discrete timing to channels on a terminated command line, those channels must be reselected. The **[Select Last]** command can be helpful. [See "Select Last" on page 123.](#)

[Label] Key

Pressing and holding **[Shift] & [Label]** toggles the view to show reference labels or numbers depending on what display setting is being used. [See "Show Reference Labels" on page 107.](#)

Using Flexichannel

Flexichannel (use of the **[Flexi]** key) allows you to view only channels meeting a certain criteria in the live/blind display, therefore removing unwanted data from view. Flexichannel has several available states which include allowing you to view:

- All channels
- All patched channels
- Manual channels
- All show channels (any channels that have data stored in a cue or submaster)
- Active channels (channels with intensity above zero or a move instruction)
- Selected channels

In flexi mode, any selected channels (including the last channel selection) are always included in the view. Gaps in channel numbers are indicated by a vertical line between the channels where a gap in numbering occurs.

To change flexi modes in the live/blind display, press **[Flexi]** to cycle through the views listed above. When **[Flexi]** is held down, the softkeys change to represent all of the available flexi states. You can select the desired flexi view from those keys.

[Next/Last] can be used to select the next or last channel in the current flexi mode.

[Thru] can be used to view only channels in the current flexi mode (except for selected channels mode) as long as either the first or last channel in the **[Thru]** range is included in the current flexi mode. To include channels not in the current flexi mode, **[Thru] [Thru]** can be used.

Flexichannel with Timing

You may also engage a “Channels with Timing” flexichannel state by pressing **[Flexi] & [Time]**. This will display all channels that have discrete timing in the current cue and will remove channels without discrete timing from view.

You may still press **[Shift] & [Time]** to view the discrete time behind any parameter or category.

The display will remain in this state until you disengage it by pressing **[Flexi] & [Time]** again.

View Channels

You may select specific channels to appear in another flexichannel state called “View Channels”. This state does not exist until you select channels to view. After view channels is activated, it will appear in the rotation of flexichannel states when **[Flexi]** is pressed.

To select channels to view:

- Step 1: Select channels on the command line (do not press **[Enter]**).
- Step 2: Press and hold **[Flexi]**.
- Step 3: Press **{View Chans}**. The “View Channels” flexi state will be created and the channels you selected will be visible in it.

The channels you selected will be visible in this flexi state until you select other channels and press **{View Chans}** again. At any time, you can access the last channels you defined for this state by pressing **[Flexi]** until this state is visible.

To redefine the selected channels in the state, simply follow the steps above again.

Indicators in the Playback Status Display

Indicates the timing for a category.

If blank, default time is used and there is no move instruction

Indicates that timing has been applied but there is no move instruction.

The screenshot shows the 'Playback Status' window for 'Cricke' & 'Cache' at 5:37:27 AM. It displays a cue list for 'List 11' with columns for Cue, Int Up, Int Down, Focus, Color, Beam, Dur, MB A P A M F V, Fw/Hg, Link, Loop, Curve, Rate, Label, and Ext Links. Cue 1 is highlighted in gold and has a '5' in the Int Up field. Cue 2 has a '5' in the Int Up field. Cue 2.5 has a '5' in the Int Up field and a '+' sign. Cue 3 has a '5' in the Int Up field and a '+' sign. Cue 4 has a '5' in the Int Up field and an '*' sign. Cue 5 has a '5' in the Int Up field, a '5' in the Int Down field, and a '+' sign. Cue 6 has a '1' in the Int Up field, a '2' in the Int Down field, a '+' sign, and a '+' sign. Cue 7 has a 'Man' button in the Int Up field. The master control bar at the bottom shows 'Master: List 11 s 4.6 100% 0.0 1 2' and various function keys (F1-F10) with indicators for wash, inh, and GM.

Sneak Counter

Color indicators

- Gold Any item (cue, list, page) highlighted in gold indicates “current”.
Outlined in gold indicates “selected”.
- Red. Cue fade is in progress (cue list area)

Text indicators

- + (see cue 6) Indicates that there is discrete timing within the associated cue. Found in the cue display “Timing” area.
- * (see cue 4) Indicates the cue has an allfade command. Found in the cue display “Flags” area.
- - Indicates a dark move, a cue that has any non-intensity parameters moving on channels whose intensity is at 0.
- x Indicates that a mark has been placed, but the mark is broken.
- A or a (see cues 3&4) Indicates an asserted cue. “A” indicates the entire cue is asserted. “a” indicates a channel or parameter assert only. Found in the cue display “Flags” area.
- B or b (see cue 2&5) Indicates a blocked cue. “B” indicates the entire cue is blocked. “b” indicates a channel/parameter block only. Found in the cue display “Flags” area.
- D. AutoMark is disabled.

- F9 (see in cue 8)Indicates a follow time associated with the cue (in this case, 9 seconds). Found in the cue display.
- H4 (see in cue 6)Indicates a hang time associated with the cue (in this case 4 seconds). Found in the cue display.
- IIndicates an intensity blocked cue. Found in the cue display “Flags” area.
- M or mIndicates a marked cue. “M” indicates an AutoMark or a reference mark that is used by a subsequent cue. “m” indicates a reference mark that is currently unused by any subsequent cue (see [Using Mark, page 191](#)). Found in the “Flags” area.
- P (see in cue 3)Indicates the cue will preheat. Found in the cue display “Flags” area.
- R (see in cue 8)Indicates the source cue which refers back to an earlier mark (see [Referenced Marks, page 193](#)).
- E 1*(see in cue 2.5)Indicates a cue level effects override.
- M1 (see in cue 3)Indicates a linked macro.
- Q2/1 (see in cue 6)Indicates a linked cue.
- S1 (see in cue 1)Indicates a linked string.



Note:

For more details on information contained in the playback status display, see [Playback Status Display, page 42](#).

Using [Format]

Some displays have multiple formats. When the display is first opened, it opens in its default view. The default view for Live/Blind is table view, with all parameter categories displayed. When the default format has been changed, those new settings will be used whenever the display is changed back to that format.

Live and Blind share formatting. When you change from one format to another format, you are always working with the same format until you change it. The exception to this is spreadsheet, which is only available in blind. If you are working in blind spreadsheet, when you return to live you will be working with the table or summary view, based on which one you were last using.

Summary View

The summary view displays the largest number of channels of any of the formats. Below you can see channels 1-60 are shown. This format is best used to see large numbers of channels' intensity data and/or parameter category data. Individual parameters are not visible in this view.

FCB icons will appear at the bottom of the channel area for channels that have those parameters patched to them.

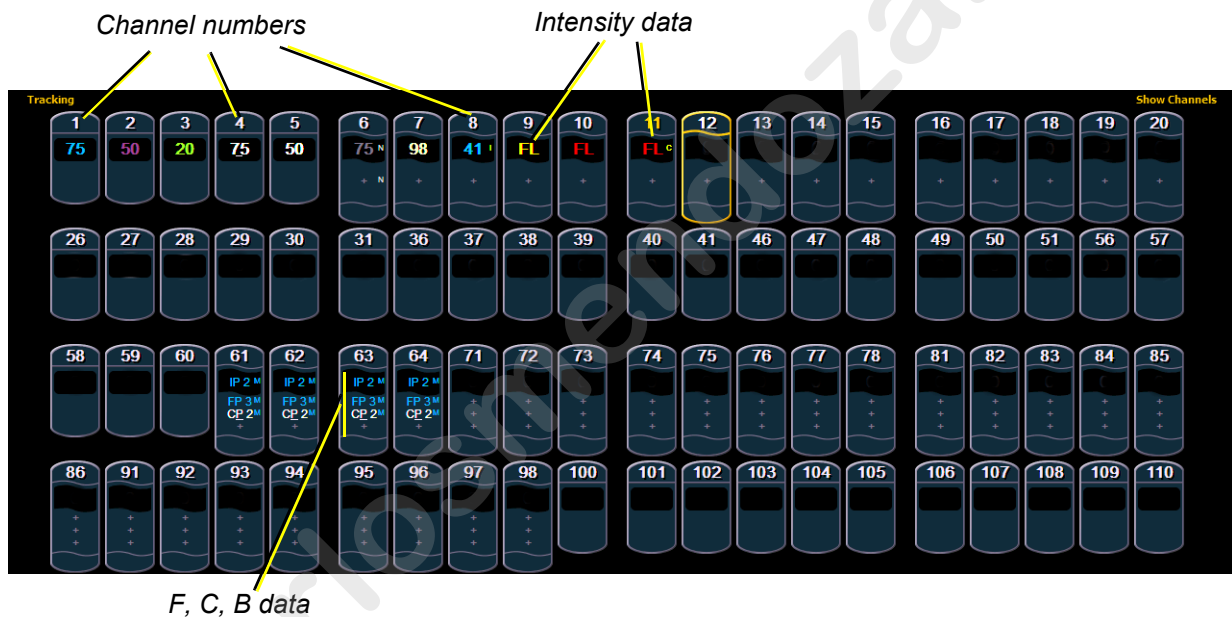

To collapse the summary view, hold down the **[Data]** key and press any encoder paging key (located to the right of the LCD).



Summary View Collapsed

When the summary view has been collapsed to show only intensity data, you may include focus, color, or beam data in the summary view by holding down the **[Data]** key and pressing any encoder paging key (located to the right of the LCD). This displays all categories.

Table View

Table view is available in live or blind. Unlike summary view, table view displays the fixture type associated with channels and details about each channel's category *or* parameter levels.

In live, table view displays all active channel data being output from Ion. In blind, it will display all data for a single record target (cue, preset, palette) depending on what is viewed. In table view, focus, color, and beam information can be viewed in either a summary of these three categories.

To expand a category to show detail, press the **[Data]** key and the associated parameter key. For example, **[Data] & [Color]** will change the color category from a summary view to a detailed one. To collapse a category, press the **[Data]** key and the associated parameter key. You cannot hide a category from view.

When a category has been expanded, to hide or reveal only certain parameters, press and hold **[Data]** and then select the parameter buttons of the appropriate parameters in the CIA. The parameters will be displayed or suppressed depending on the current view.

Notice that when you hold down the **[Data]** button, the buttons of parameters that are currently selected for viewing will be highlighted in the CIA.

In the table view, a slight space is provided between fixture types, giving a clear delineation between them. The name of the fixture type is displayed at the top of the section for that fixture.

Channels with only intensity parameters will display the same as in summary view.

The screenshot displays the 'Live Table' interface for 'Cricket & Cache' at 4:00:48 AM. The interface is divided into several sections:

- Tracking:** A grid of channels (6-20) with parameters: Dimmer, Color (Scroller, Hue, Saturate), and IP 3.
- Expanded category:** A detailed view of the Color parameters (Scroller, Hue, Saturate) for channels 26-31.
- Parameter data:** Individual parameter buttons for channels 40-51.
- Summarized category:** A simplified view of the Color parameters (Scroller, Hue, Saturate) for channels 61-64.
- Fixtures with only type-specific parameters displayed:** A section for 'Mac 700 Profile Basic' with parameters: Focus, Color (Cyan, Magenta, Yellow, Color Select, Color Wheel Mode, Hue, Saturate, Wheel Shade, Wheel Shade Mode), and Beam.
- Fixture types:** The name 'Mac 700 Profile Basic' is displayed above the fixture-specific parameters.
- List 1:** A table with columns: Cue, Int Up, Int Down, Focus, Color, Beam, Dur, M, B, A, P, A, M, F, V, Fw/Hg, Link, Loop, Curve, Rate, Label, Ext Link. Row 7 shows: Cue 7, Int Up 5, Int Down 5, Focus 5, Color 5, Beam 5, Dur 5, M L, Label 'blue blinder', Ext Link 'Q6 / 4'.
- Bottom:** 'LIVE: Cue 7 : 1. Live Table'

Live Table View

Spreadsheet (Blind Only)

Spreadsheet format is available only in blind mode. It is useful for viewing channel data and trends for multiple cues, submasters, palettes, or presets at one time. Cues and other record targets are displayed on the vertical axis and channel data is visible on the horizontal axis.

Since this is a blind-only view, changes made in this view are immediate and do not require a record or update.

As with table view, spreadsheet format allows you to choose exactly which parameters you want to view. Parameters can be expanded/suppressed by holding **[Data]** and pressing the desired parameter buttons in the CIA. Category data is not available in spreadsheet, but you may hide all parameters of a specific category by holding **[Data]** and pressing the desired parameter category button (also called "encoder paging keys"). By default, the spreadsheet view displays just intensity.

Cue numbers Channel number Parameters

Blind Spreadsheet Cricket & Cache 12:20:11 PM

Cue	1	2	3	4	5	6	7	8	9	10	11
1	50	50	50	50	50						
2	40	40	40	75	75						
3	30	30	30	30	30	92	92	92	92	92	92
4	30	30	30	30	30	92 A	92 A	92 A	92 A	92 A	92 A
5	30 A	30 A	30 A	30 A	30 A	92	92	92	92	92	92
6	30	30	30	30	30	92	92	92	92	92	92
7	30	30	30	30	30	25	25	25	25	25	25
8	30	30	30	30	30	25	25	25	25	25	25

List 11 Timing Flags Attributes

Cue	Int Up	Int Down	Focus	Color	Beam	Dur	M	B	A	P	A	M	F	V	Fw/Hg	Link	Loop	Curve	Rate	Label	Ext Links
1	1	2				1	m								F5						S1

BLIND: Cue 11 / 1 : Cue 11 / 1

1. Blind Spreadsheet 3: Cue List Index

Playback Status Display

The playback status display allows you to view a range of cues in the current cue list, all cue attributes for those cues, and a view of the fader configurations for 10 pages of 10 faders each (for a total of 100 visible faders).

Holding down **[Time]**, while a cue is fading, will display the cue category times counting down in the cue list display area. The default action is to show the total time not the countdown. To always show the countdown, a **{PSD Time Countdown}** option is available in Setup, see [{Displays}, page 107](#). When the **{PSD Time Countdown}** is enabled, the cue category times will countdown as a cue is fading. To see the total time, hold down the **[Time]** key. **{PSD Time Countdown}** is “disabled” by default.

When focus is on the playback status display, you can use the paging keys to navigate in the display. An optional command line for the playback status display is available. The optional command line must be enabled to use. See [“{Displays}” on page 107](#).

There are three formats for the playback status display. By default, it will be an expanded cue list format. With the playback status display selected, press **[Format]** to toggle between the formats.

Expanded Cue List Format

Pressing **[Format]** with the playback status display active will access this format. In expanded cue list, the view of the active cue list increases to the full size of the display. The current fader page is still visible at the bottom of the screen.

The screenshot shows the Playback Status display in expanded cue list format. The display is titled "Cricket & Cache" and shows the time "6:40:00 AM". The cue list is titled "List 11" and "Timing". The table below shows the cue list:

Cue	Int Up	Int Down	Focus	Color	Beam	Dur	M B A P A F M V	Fw/Hg	Link	Loop	Curve	Rate	Label	Ext Links
1	1 / 2					1	m	F5						S1
2	5					5	B A	H3						
2.5	5	+				12								E 1*
3	5			5		5	A P L		1	3				M1
4	5			5		5	a *							
5	5 (5) /		5	5	5	10	b a L						Test 1 2 3	
6	1 / 2	+	3	4	5	20	M	H4			901			Q2 / 1
7	Man					0								
8	5					3.33	R a	F9				150		Relay1 / 1

Below the table, the fader control area shows the "Master:" section with "List 11" selected, "S 0.5", "100%", and "0.0". The fader page number is "1" and the fader numbers are "1" through "10". The fader numbers are labeled "F1" through "F10". The fader page number is labeled "Fader page number" and the fader numbers are labeled "Fader numbers".

Split Playback Status Display

Pressing **[Format]** with the playback status display active will access this format. With the playback status display split, two different cue lists can be displayed at the same time by locking. If both cue lists are unlocked, they will display the same list.



Note:

The first time you access the split playback status display, you may need to adjust the splitter bar between the two lists to see the second list.

Locked cue list

Unlocked cue list

The screenshot shows the 'Playback Status' window for 'Cricket & Cache' at 6:40:44 AM. It is split into two sections: 'List 11' (locked) and 'List 1' (unlocked). Below these is a 'Master' control bar and an 'Optional Command Line'.

Cue	Int Up	Int Down	Focus	Color	Beam	Dur	M	B	A	P	A ^M	F ^V	Fw/Hg	Link	Loop	Curve	Rate	Label	Ext Links
1	1	2				1	m						F5						S1
2	5					5	B	A					H3						E 1*
2.5	5					12													M1
3	5			5		5	A	P	L					1	3			Test 1 2 3 1	
4	5			5		5	a	*											
5	5	5		5	5	10	b	a	L										
6	1	2	3	4	5	20	M						H4			901			Q2 / 1
7	Man					0													

Cue	Int Up	Int Down	Focus	Color	Beam	Dur	M	B	A	P	A ^M	F ^V	Fw/Hg	Link	Loop	Curve	Rate	Label	Ext Links
1	5		5	5	5	2.5											200		Q6 / 1
2	4	8				8								2/1				scene1	
2.5	5					12													E 1*
3	10					10	b											scene2	Q6 / 2
4	5	5				10												scene3	
5	3	3	5	5	5	20			L									fun stuff	Q6 / 3
6	5		2	10	5	10			L									cool stuff	
7	5		5	5	5	5			L									blue blinder	Q6 / 4

Master: List 11 100% 0.0 1 2

1 0.0 L3 0 S1 wash 0 S2 inhib 0 S3 0.0 L6 100 GM

F1 F2 F3 F4 F5 F6 F7 F8 F9 F10

LIVE: Cue 2.5: Cue 1 /

1. Live Table 3. Cue List Index 4. Effects Playback Status

Optional Command Line

Fader Display Format

Pressing **[Format]** with the playback status display active will access this format.

The screenshot displays the Fader Display Format interface, which is divided into two main sections: a cue list table and a master cue list timeline.

Cue List Table: This table lists cues for "List 11" with columns for Cue, Int Up, Int Down, Focus, Color, Beam, Dur, MB A P A M F V, Fw/Hg, Link, Loop, Curve, Rate, Label, and Ext Links. Cues 1 through 8 are shown, with cue 1 highlighted. A yellow box highlights the "Timing" columns (Int Up, Int Down, Focus, Color, Beam, Dur) for cues 1 through 5.

Master Cue List Timeline: This section shows a timeline for "List 11" with a master cue list (1-10) and submasters (S1, S2, S3, S10, S20). The timeline includes a "Master cue list timeline" and "Faders 1-10". A yellow box highlights the "Other cue list" (1-10) and "Submasters" (S1, S2, S3, S10, S20) columns.

Labels and Callouts:

- Current cue list:** Points to the "List 11" header.
- Cues:** Points to the "Cue" column.
- Timing data:** Points to the "Timing" columns (Int Up, Int Down, Focus, Color, Beam, Dur).
- Cue flags:** Points to the "MB A P A M F V" column.
- Cue attributes:** Points to the "Fw/Hg, Link, Loop, Curve, Rate, Label, Ext Links" columns.
- Other cue list:** Points to the "1-10" cue list in the timeline.
- Submasters:** Points to the "S1, S2, S3, S10, S20" submasters in the timeline.
- Master cue list timeline:** Points to the "1-10" cue list in the timeline.
- Faders 1-10:** Points to the "F1-F10" faders in the timeline.

Encoders

The encoders are one of two ways to control the non-intensity parameters (NPs) of multiple-parameter devices. The four encoders are identified by the encoder LCD, just beneath the encoders.

Encoder Navigation

Use the encoder page buttons (located to the upper right of the encoder LCD) to choose which parameters are currently available on the encoders. There are six readily usable buttons: **[Focus]**, **[Color]**, **[Custom]**, **[Form]**, **[Image]**, and **[Shutter]**. Pressing any of these will change the parameters controlled by the encoders.

Some fixtures have more parameters than can be displayed on one encoder page. The number of pages for each category is displayed at the right side of the encoder screen. To view the other pages, simply press the **[Color]**, **[Custom]**, **[Shutter]**, **[Image]**, or **[Form]** button to advance the pages, or press an encoder button with a number key to go directly to the page you want to access. The number of pages is indicated in the LCD.

Encoders can be switched from course mode into fine by holding down **[Shift]** while using an encoder will put it in fine mode for as long as **[Shift]** is held down. Once **[Shift]** is released, the encoder will return to course mode.

Locking the Encoders

It is possible to lock out the encoders. To lock out the encoders, press **[Escape]** & [Encoder Page Keys]. To unlock, press any of the [Encoder Page Keys].

Encoders in Blind

The encoders and level wheel are disabled by default when in the blind display. Pressing an [Encoder Page Keys], for example **[Color]**, will enable the encoders and level wheel. When the encoders are disabled, trackball functionality for pan and tilt will also be disabled.

Flexi Encoders

Holding down **[Flexi]** and an [Encoder Page Keys], for example **[Image]**, will put the encoders into Flexi mode. In Flexi mode, any empty locations for parameters not applicable for selected channels will be suppressed.

Moving Light Controls

An additional tool for controlling the non-intensity parameters (NPs) of multiple parameter devices is the ML Controls. The ML Controls is found with the other virtual controls in the browser. Navigate to **Browser>Virtual Controls>ML Controls**.

You will need to have a multi-parameter device selected to properly view this display. The display will change based on the device selected. If you have a device that only has intensity and color parameters, the ML Control display will only show intensity and color parameters.

ML Controls

Controls available in this display will change based on the fixture selected.

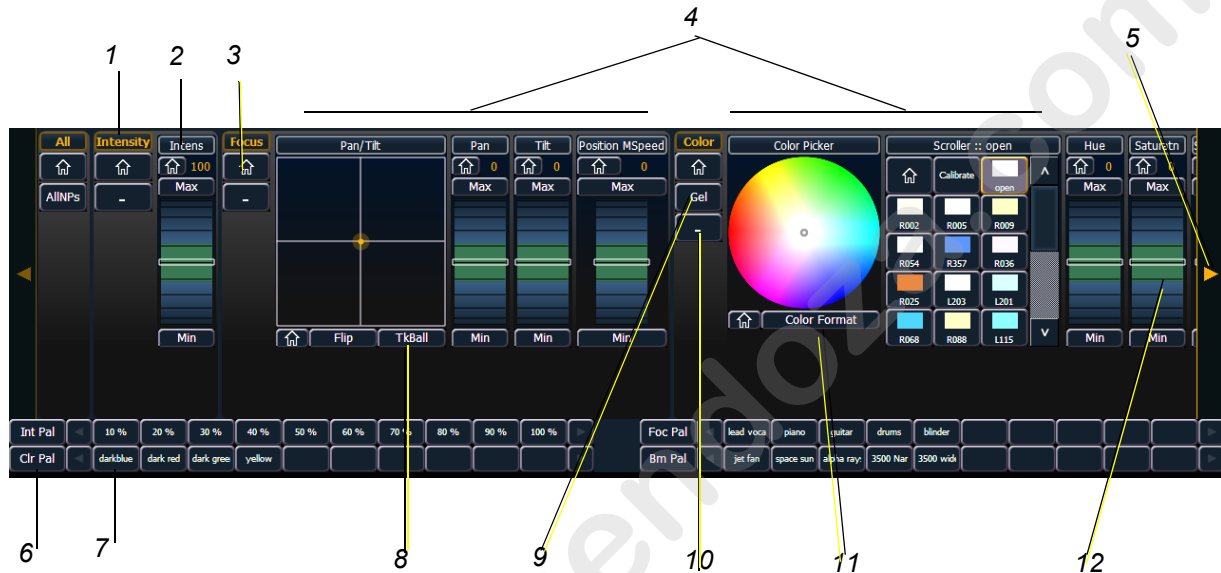

- 1 Category button (Clicking this button will show or collapse the encoder wheel, see #12)
- 2 Parameter button (Clicking the button will put the parameter on the command line.)
- 3 Home button allows you to home a specific parameter or attribute of a parameter.
- 4 Parameter attributes
- 5 Arrow to scroll through a fixture's available categories.
- 6 Palette button (Clicking the button will put the palette on the command line.)
- 7 Palette Select buttons. Will display number or label.
- 8 Gives pan and tilt functionality to a mouse or trackball.
- 9 Opens the gel picker.
- 10 Collapses or expands categories.
- 11 Toggles the color format from Hue/Saturation to absolute parameter data and back.
- 12 Virtual encoder (Click and hold close to the center line for slow movement, further away for faster movement.)

Using Softkeys

Some of the features and displays in Ion are accessible from the softkeys, which are located in the bottom right area of the LCD.

Pressing the **[Displays]** button accesses the following softkeys:

- Effect Status
- Color Picker
- Patch
- Setup
- Browser
- Magic Sheets
- Command History
- Curves
- Pixel Maps
- Show Control
- Mirror

Context Sensitive Softkeys

Softkeys are context sensitive and will change depending on the active display, the current command in the command line, the active record target and so on.

Changing Softkey Pages

When there are more relative softkeys than the six available softkey buttons, the LED in the **[More SK]** button will light. Press **[More SK]** to view the additional softkeys.

www.carlosmendoza.com.mx

Chapter 3

Managing Show Files

This chapter explains how to create, open, and save your show files. Each of these operations are accomplished through the browser area in the CIA.

This chapter contains the following sections:

- **Create a New Show File** 50
- **Open an Existing Show File** 50
- **Merging Show Files** 54
- **Printing a Show File** 55
- **Saving the Current Show File** 57
- **Using Quick Save** 57
- **Using Save As** 57
- **Importing Show Files** 57
- **Exporting a Show File** 58
- **Deleting a File** 58
- **File Manager** 58

Create a New Show File

To create a new show file, navigate within the browser to: **File> New>** and press **[Select]**.

You will be prompted for confirmation that you want to create a new show. Press **{OK}** to confirm or **{Cancel}** to discontinue the operation. **{Patch 1to1}** will be selected by default. If you wish to not have a 1 to 1 patch, deselect the **{Patch 1to1}** button and click **{Ok}**.

A new show created with **{Patch 1to1}** selected will have a 1 to 1 patch and 1 to 1 channel to sub assignment.

Open an Existing Show File

Names of show files may appear in the browser list in normal text or in **bold text**. Files in normal text indicate that there is only one show file stored by that name.

Bold show names indicate that there are several versions of the show file stored under that name, the bold one being the most recent. To access the most recent show file, simply select the bold name. You may right arrow **[↵]** from the bold name to expand a list of previous versions beneath it in the browser. Select the desired show from the expanded list.

To open an existing Ion show file, navigate within the browser to: **File> Open>** and press **[Select]**.



Ion provides you with multiple locations to retrieve an Ion show file (.esf) including:

- Show File Archive - This is the default storage location for show files when a show file is created and saved. Older versions of the show file will be listed under the most current version. This allows you the ability to open the latest version or an earlier version of a show file if desired.
- File server - if one is connected. When there is no file server connected, it will not display in the browser.
- USB device - When a USB device is connected and an Ion show file (.esf) is available on the device, you will notice the USB is displayed in white text and is expandable.

Open the desired location:

- To open a show file from the Show File Archive, navigate within the browser to: **File> Open> Show File Archive** and press **[Select]**.
- To open a show file from the file server, navigate within the browser to: **File > Open> File Server>** and press **[Select]**.
- To open a show file from a USB device, navigate within the browser to: **File> Open> Name of Drive** and press **[Select]**.

Select the specific show file

- Navigate within the specified storage location and select the show file you wish to open, press **[Select]**.
- If the selected show has multiple time stamps and you wish to load an older version, navigate to the desired revision and press **[Select]**.

This will open the partial show loading screen in the CIA.

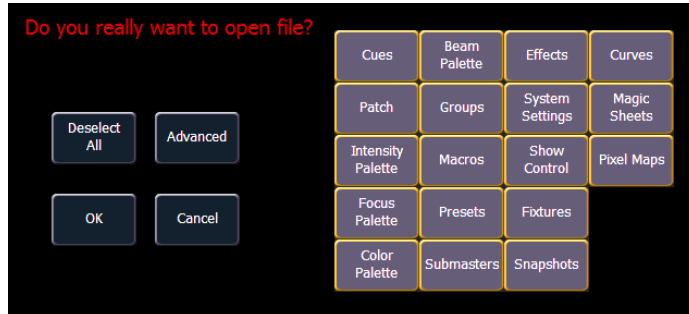

From this screen you can select which components of the show file you wish to load. The buttons at the center of the CIA represent all of the show components that you can choose to load. By default all components are selected (gray) and will be loaded. To withhold any show components from loading, simply deselect them in the CIA by clicking the respective button.

To reselect all show components, click the **{Reset}** button and all buttons will return to gray (selected). To stop the show load process, click the **{Cancel}** button.

When you have selected or deselected all of the show components you require, click **{OK}**.

Ion loads the selected show to the console.



CAUTION:

On a partial show open, if any record targets are not opened, any existing data of that type will be cleared from the console. To merge show data, merge should be used. See "Merging Show Files" on page 54.

Selective Partial Show Opening

If you select the **{Advanced}** button in the partial show opening screen, you will have the opportunity to load partial components from the show file and be able to specify the desired location of those partial components in the new show file.



CAUTION: *On a partial show open, if any record targets are not opened, any existing data of that type will be cleared from the console. To merge show data, merge should be used. See “Merging Show Files” on page 54.*

For example, you could specify only cues 5-10 from cue list 2 and load them as cues 20-25 in cue list 7 in the new show. You could also specify only specific palettes, presets, effects, and so on. To see the complete list of show components, press the **{Advanced}** key in the partial show loading screen.

Do you really want to open file?

Type	List	List Target	Start	End	Target
Cues					
Patch					
Groups					
Effects					
Presets					

Selected Show Components

As you specify components, they are added to a table in the CIA. In the table, fields with a dark background may be edited, fields with a light gray background do not apply to that component. For each component in the list, you can specify the desired range by clicking in the proper area in the table and entering numbers from the keypad. The columns in the table are:

- List - The list you are taking data from (such as a cue list).
- List Target - The list you are adding the data to.
- Start - The first in a range of components (such as a range of cues).
- End - The last in a range of components.
- Target - The desired location of the components in the new show file (for ranges, this will be the location in the new show of the first component in the range, the others will follow in order).

To open only partial components from a show file:

- Step 1: From the browser, navigate to the desired show file (see [Open the desired location;](#), page 50).
- Step 2: When the partial show load screen appears, click the **{Advanced}** button. The partial components selection screen will appear in the CIA.
- Step 3: Select the show components that you wish to load by clicking on their respective buttons on the left side of the CIA. The components will appear in the list to the right as you select them.
- Step 4: Click any fields for which you want to enter specific numbers. The field (if editable) will highlight in gold.
- Step 5: Enter the numbers using the keypad to specify the desired cues/groups/effects and so on.
- Step 6: Click **{OK}** to load the components to the new show.

You may exit the partial show load screen at any time by clicking the **{Cancel}** button. This will return you to the browser.

You may clear all selected components from the table at any time by clicking the **{Reset}** button.

You may exit the advanced loading screen at any time by clicking the **{Advanced}** button. This will return you to the general partial show load screen.

Partial Patch Opening

You have the option to selectively open partial patch information or fixtures into a show file by selecting the **{Advanced}** button in the partial show opening screen.



Note:

It is important to remember that on a partial patch open, if any record targets are not opened, any existing data of that type will be cleared from the console. To keep that data, merge should be used.

You can specify the desired range by selecting the proper area in the table and entering numbers from the keypad. The columns in the table that relate to patch are:

- Start - The first in a range of components.
- End - The last in a range of components.
- Target - The desired location of the components in the new show file (for ranges, this will be the location in the new show of the first component in the range, the others will follow in order).

Merging Show Files

Ion supports the merging of .esf show files.



Note: *Merging show files is different from opening show files. When you do a partial open of show components, untouched record targets are cleared. When you do a merge, those record targets remain.*

You have the option of merging .esf show files from the Show File Archive, a File Server (if connected), or a USB device.

To merge a show file, navigate within the Browser to: **File> Merge>**. Navigate to the desired storage location and press **[Select]**. When using merge, Ion displays only the available files. Navigate to the specific file and press **[Select]**.

This will open the merge screen in the CIA. From this screen you can choose which aspects of the show file you want to merge. By default all aspects are unselected (black). Selected show aspects will appear in gray.

If you select the **{Advanced}** button in the merge show loading screen, you will have the opportunity to load partial components from the show file and be able to specify the desired location of those partial components in the current show file.

For example, you could specify only cues 5-10 from cue list 8 and load them as cues 20-25 in cue list 7 in the current show. You could also specify only specific palettes, presets, effects, and so on. To see the complete list of show components, press the **{Advanced}** key in the merge show loading screen.



Selected Show Components

As you specify components, they are added to a table in the CIA. In the table, fields with a dark background may be edited, fields with a light gray background do not apply to that component. For each component in the list, you can specify the desired range by pressing the proper area in the table and entering numbers from the keypad. The columns in the table are:

- List - The list you are taking data from (such as a cue list).
- List Target - The list you are adding the data to.
- Start - The first in a range of components (such as a range of cues).
- End - The last in a range of components.
- Target - The desired location of the components in the new show file (for ranges, this will be the location in the new show of the first component in the range, the others will follow in order).

To merge only partial components:

- Step 1: From the browser, navigate to the desired show file (see [Open the desired location;](#), [page 50](#)).
- Step 2: When the merge show load screen appears, press the **{Advanced}** button. The partial components selection screen will appear in the CIA.
- Step 3: Select the show components that you wish to merge by pressing on their respective buttons on the left side of the CIA. The components will appear in the list to the right as you select them.
- Step 4: Press any fields for which you want to enter specific numbers. The field (if editable) will highlight in gold.
- Step 5: Enter the numbers using the keypad to specify the desired cues/groups/effects and so on.
- Step 6: Press **{OK}** to load the components to the current show.

Partial Patch Merging

You have the option to selectively merge partial patch information into a show file by selecting the **{Advanced}** button in the partial show merge screen.

You can specify the desired range by selecting the proper area in the table and entering numbers from the keypad. The columns in the table that relate to patch are:

- Start - The first in a range of components.
- End - The last in a range of components.
- Target - The desired location of the components in the new show file (for ranges, this will be the location in the new show of the first component in the range, the others will follow in order).

Printing a Show File

Ion provides you with the ability to save a show file or aspects from a show file to a PDF file for printing. Ion has three locations to save the PDF files including the Show File Archive, the File Server (if connected), or a USB device (if connected). Saving the PDF file to a USB (F:) device, allows you to then print the PDF from a personal computer. Printing directly from Ion is not supported. To save a PDF of an Ion show file, navigate within the browser to: **File> Print>** and press **[Select]**.



This will open the printing screen in the CIA. From this screen you can choose which aspects of the show file you want to save to PDF. By default all aspects are selected (gray) and will be saved. To

withhold any show aspects from printing, simply deselect them in the CIA by touching the respective button. Deselected show aspects will appear in black.

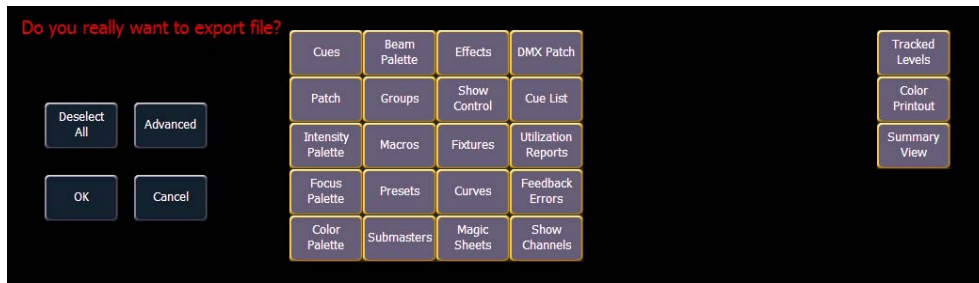

To reselect all show aspects, press the **{Reset}** touchbutton and all buttons will return to gray (selected). To stop the show file from being saved to a PDF and return to the browser, press the **{Cancel}** button. When you have selected/deselected all of the show aspects you require, press the **{OK}** touchbutton to create the PDF file.

You can also choose to print specific portions of show aspects. To select this information, press the **{Advanced}** button. The touchbuttons at the center of the CIA will again represent all of the show aspects that you can choose. By default all aspects will be deselected (black).

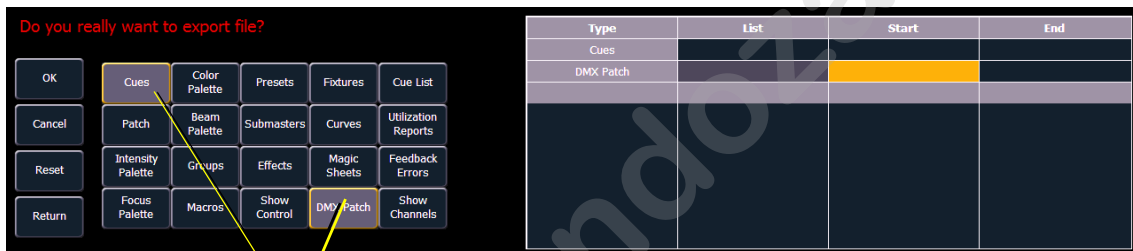

Selected Show Component

As you select aspects, they will be added to the table in the CIA. For each component in the list, you can specify the desired range by pressing the proper area in the table and entering numbers from the keypad. The columns in the table are:

- List - The list you are taking data from (such as a cue list).
- Start - The first in a range of components (such as a range of cues).
- End - The last in a range of components.

To deselect all show aspects, press the **{Reset}** touchbutton and all buttons will return to black (deselected).

To return to the main print screen, press the **{Advanced}** button. To stop the show file from being saved to a PDF file and return to the browser, press the **{Cancel}** button. If you are ready to save the file, press the **{Ok}** button. You will be prompted to name the file.

The PDF will have the show name, date and time it was created, and date and times for when the show file was last saved. It also gives the Ion software version information. If multiple aspects were selected to save to the file, there will be hyperlinks at the top of the PDF so you can quickly jump to a section.

Saving the Current Show File

To save the current show data, navigate within the browser to: **File> Save>** and press **[Select]**.

The Show File Archive is the default storage location for show files when they are saved. The new time stamp located beneath the show file name on the CIA indicates that the show file has been saved.

All previous saves are stored in the Show File Archive with the time stamp following the file name.

Using Quick Save

To save the current show data to the hard drive without having to navigate to the browser, hold down **[Shift] & [Update]**.

Using Save As

To save an existing Ion show file to a different location or with a different name, navigate within the browser to: **File> Save As>** and press **[Select]**.



Ion provides you with three locations to save an Ion show file (.esf) including the Show File Archive, the File Server (if connected) or a USB device (if connected).

Navigate to the desired storage location and press **[Select]**. When using “Save As” to save the show file to a specific location, the alphanumeric keypad will display on the CIA. Name the show file and press **[Enter]**. The show file will be saved in the specified location with the show file name you entered with a time stamp suffix.

By default, the current show file name will be used. Pressing **[Label]** or **[Delete]** on the console, or DELETE on an alphanumeric keyboard will remove the default show label when doing a Save As.

Importing Show Files

Ion supports the import of standard USITT ASCII and Lightwright® text files.



Note:

Ion supports ASCII show file import from a number of other control consoles, including the Congo, Obsession, Expression and Emphasis product lines, as well as the Strand 300 Series. Please note that all show files must be saved in an ASCII format prior to importing them into Ion.



CAUTION:

The way data is stored and used is often different between different desks. Imported data may not playback exactly the same between desks. Not all data (such as effects and macros) may be imported. This varies by product.

You have the option of importing standard USITT ASCII (.asc) or Lightwright (.txt or .asc) from the Show File Archive, a File Server (if connected), or a USB device.

To import a show file, navigate within the Browser to: **File> Import> (Type of file to import)** and press **[Select]**. If you are importing an USITT ASCII file, you will have two options, Import as Library Fixtures or Import As Custom Fixtures. Import as Library Fixtures will allow Ion to try to match the fixtures in the file with fixtures in the Ion library. Import as Custom Fixtures will bring the fixtures in as they are in the file. It is recommended to use Import as Custom Fixtures.

Navigate to the desired storage location and press **[Select]**. When using import, Ion displays only the available files. Navigate to the specific file and press **[Select]**.

Exporting a Show File

Export your Ion show file to a standard USITT ASCII, .csv, Focus Track, or Fast Focus Pro show file using the export feature.

To export your Ion show file in ASCII format, navigate within the browser to: **File> Export>** and press **[Select]**

You have the option of exporting your show file in ASCII format to the Show File Archive, to a File Server (if connected), or to a USB device.

Navigate to the desired storage location and press **[Select]**. The alphanumeric keypad will display on the CIA. Name the show file and press **[Enter]**. The file will be saved in the specified location with the file name you entered with a “.asc” file extension.

You can export Ion show files as a .csv format by navigating within the browser to: **File> Export> CSV** and select the location for the export, the Show File Archive, a File Server (if connected), or to a USB device.

Files can also be exported as in a Focus Track or Fast Focus Pro format by going to **File> Export> Fast Focus Pro** or **Focus Track** and select the location for the export, the Show File Archive, a File Server (if connected), or to a USB device.

Deleting a File

Ion provides you with the ability to delete show files from the Show File Archive and the File Server from within the browser.

To Delete a Show File

Navigate within the browser to: **File> Open** and press **[Select]**. Navigate to the desired show file and press **[Delete]**. Press **[Enter]** to confirm or any other key to abort the deletion process.

To Delete a Folder

The folder must first be empty.

Navigate within the Browser to: **File> Open** and press **[Select]**. Navigate to the desired folder and press **[Delete]**. Press **[Enter]** to confirm or any other key to abort the deletion process.

File Manager

Ion has a file manager, which provides a way to manage show files. [See “File Manager” on page 347.](#)

Chapter 4

Patch

Patch is where fixture assignments and properties are stored and can be viewed. Once a channel is patched to an output, and the output is connected to a device (for example a dimmer, moving light, or accessory), the channel will then control that device.

This chapter contains the following sections:

- **About Patch**60
- **Displays**61
- **Patching Conventional Fixtures**63
- **Using the Scroller/Wheel Picker and Editor**68
- **Patching Moving Lights, LEDs, and Accessories**75
- **Display Pages in Patch**76
- **Using Device List**82
- **Clearing the Patch**87
- **Fixture Creator**88

About Patch

Ion treats fixtures and channels as one and the same, meaning each fixture is assigned a single control channel number. Individual parameters of that fixture, such as intensity, focus, color, and beam are also associated with that same channel number but as additional lines of channel information.

Patching can be done via two different methods: manually entering a patch and by patching devices using RDM via the Device List in patch. RDM allows bi-directional communication between the desk and any RDM devices over RDM or Ethernet. [See “Using Device List” on page 82.](#)

For manual patching, you are required to enter only the simplest data to patch a device and begin programming your show, such as the channel number, the device type (if needed), and address. When you provide more information in the patch, you will have more detailed control and improved function during operation.

One or more devices may be patched to a single channel. For example, you may want to patch a group of dimmers to the same channel. In addition you may patch multiple devices to the same channel for building a compound or accessorized fixtures. For example a Source Four[®] with a color scroller and a gobo changer may be patched to a single channel. This is referred to as a compound channel. [See “Creating multi-part and compound channels” on page 67.](#)

Displays

To begin patching your show, you must first open the patch display. To open the patch display, press **[Displays]** and then **{Patch}**.

The patch display will open on an available external monitor and the CIA will display patch controls. If there are no monitors attached, patch will open on one of the on-board monitors.

From within the patch display, you can open the Device List to use RDM to patch any RDM compatible devices. For more information about Device List, see [Using Device List, page 82](#).

Chan	Address	Type	Label	Interface					Output
				ACN	EDMX	DMX	AVAB	ARTN	
1	1	Dimmer		*	*	*			0
2	2	Dimmer		*	*	*			0
3	3	Dimmer		*	*	*			0
4	4	Dimmer		*	*	*			0
5	5	Dimmer		*	*	*			0
6	P1 51	Dimmer		*	*	*			0
	P2 71	Coloram 2 Scroller		*	*	*			0
7	P1 52	Dimmer		*	*	*			0
	P2 72	Coloram 2 Scroller		*	*	*			0
8	P1 53	Dimmer		*	*	*			0
	P2 73	Coloram 2 Scroller		*	*	*			0
9	P1 54	Dimmer		*	*	*			0
	P2 74	Coloram 2 Scroller		*	*	*			0
10	P1 55	Dimmer		*	*	*			0
	P2 75	Coloram 2 Scroller		*	*	*			0
11	P1 56	Dimmer		*	*	*			0
	P2 76	Coloram 2 Scroller		*	*	*			0
12	P1 57	Dimmer		*	*	*			0
	P2 77	Coloram 2 Scroller		*	*	*			0

Patch Channel:
1. Live Table 4. Patch

The patch screen will display the following information if available:

- **Channel** - the patched channel number. In patch by address mode, channel will appear blank if not currently patched.
- **Address** - the patched output address. In patch by channel mode, address will appear blank if not currently patched. Pressing **[Data]** toggles the display from showing address as patched by the user, output address, and the port/offset. See [“Using Output Address vs Port/Offset” on page 64](#).
- **Type** - device or dimmer type that is patched.
- **Label** - displays the assigned label of the channel or address. See [Labeling, page 62](#).
- **Interface** - displays which interfaces will be used for the device. See **{Interface}** in [{Patch} Display and Settings, page 76](#).
- **Output** - displays the current live intensity level. Value is displayed as 0-255, with 255 being full.

Status in the Patch Display

Status flags will display on the far left of the patch display to advise you when a channel or address requires your attention.

A red “!” or yellow “?” will display when there is a warning or error from an RDM, CEM+, CEM3, or ACN device. See [“Errors and Warnings” on page 86](#).

Flexichannel Views in Patch

In patch by channel mode, **[Flexi]** can be used to view only those channels that are currently patched. In patch by address mode, **[Flexi]** can be used to view only those addresses that are currently patched. By pressing **[Flexi]**, you can toggle the view between patched channels/addresses, selected channels, and all channels/addresses.

Holding down **[Flexi]** will display the following softkeys:

- **{Flexi All}** - displays all the channels or addresses depending on which view is used.
- **{Patch}** - displays only the patched channels or addresses.
- **{Selected}** - displays any selected channels or addresses.
- **{View Channels}** - displays those channels selected for the View Channels flexichannel state.
- **{Partitioned}** - only available when partitioning is enabled. Displays the following options:
 - Partitioned Channels
 - Partitioned Patched Channels
 - Partitioned Selected Channels
 - Partitioned View Channels

Labeling

To label a channel or address, press the **[Label]** key with the channel or address selected on the command line. You can use the virtual alphanumeric keyboard or an external keyboard to enter the desired label text.

Patching Conventional Fixtures

For patching fixtures, there are two different patch modes: patch by channel and patch by address. Ion defaults to patch by channel mode. Pressing **[Format]** while in the patch display will toggle the mode between patch by channel and patch by address.



Note: *When working with conventional devices, you can patch in either mode easily. When working with compound channels or multiple parameter devices, such as moving lights, it is recommended to work in patch by channel.*

Patching By Channel

Chan	Address
1	1
2	2
3	3
4	4
5	
6	P1 51
	P2 71

In patch by channel mode, **[2] [0] [At] [1] [Enter]** patches channel 20 to address 1. Pressing **[At]** will post address to the command line while patching by channel.

Additional examples of patch by address:

[5] [At] [1][0][0] [Enter] - patches channel 5 to address 100.

[2][0][3] [At] [1][2] [Enter] - patches channel 203 to address 12.

Range Patching

Range patching using the **[Thru]** key allows you to quickly patch a group of channels. **[1][Thru][2][0] [At] [1] [0] [Enter]** patches channels 1 through 20 to addresses 10 through 29.

You can also use the **[+]** and **[-]** keys. **[1] [+][4] [+][8] [At] [1] [Enter]** patches channel 1 to address 1, channel 4 to 2, and channel 8 to 3. The **[Group]** key can also be used if groups have been created.



Note: *Range patching only works with channels. If you try to range patch addresses, parts for the channel will be created. See "Creating multi-part and compound channels" on page 67.*



Note: *If you try to patch a channel or address that exceeds the desk's capacity, an error message saying number out of range will display on the command line.*

Patching By Address

Address	Chan
1	1
2	2
3	3
4	4
5	21 P3
6	21 P1
7	21 P2

Pressing **[Format]** while in the patch display will toggle the mode between patch by channel and patch by address.

[2] [0] [At] [1] [Enter] patches address 20 to channel 1. Pressing **[At]** will post channel to the command line while patching by address.

Additional examples of patch by address:

[5] [At] [1][0][0] [Enter] - patches address 5 to channel 100.

[2][0][3] [At] [1][2] [Enter] - patches address 203 to channel 12.



Note: *If, at any point, you try to patch an address that is already in use, Ion will post an advisory to indicate this, preventing you from duplicating addresses in your patch.*

Using Output Address vs Port/Offset

The output address is the DMX or network DMX (often called EDMX) address. Examples of output addresses are 510, 1, and 1024.

Port/offset refers to the DMX universe or port and the offset of the address. For example, since a single DMX port can transmit 512 addresses (known as a “universe”), the port/offset for address 515 would look like 2/3 because address 515 is the 3rd address of universe 2.

An example of patching by port/offset in patch by address mode is **[2]/[1][0] [At] [2][0] [Enter]**, which patches universe 2 address 10, or 522, to channel 20.



Note: *As it is possible to patch by either address or port/offset, pressing the **[Data]** key will move between showing the patch as it was originally entered, then the output address values, and last the port/offset.*



Note: *An address can not be assigned to multiple channels, but a channel can have multiple addresses assigned to it.*

Replace

By default, if you patch an address to a channel that is already patched, Ion will create a new part for the new address. If you want to replace the current address with the new, use **{Replace}**:

- **[n] {Replace} [n] [Enter]** - replaces the address in part 1 of the selected channel.

Helpful Hints

[At] [Next] [Enter] finds the next available address range large enough to accommodate the selected device.

Examples of **[At] [Next]**:

- **[At] [2] [/] [Next] [Enter]** - finds the next available address range on universe 2.
- **[At] [7] [7] [7] [Next] [Enter]** - finds the next available address after 777.

[At] [/] [n] [Enter] can be used to patch an address on the same universe that was last used.



Note: *You can open or merge patch data from other show files, see [Partial Patch Opening, page 53](#) and [Partial Patch Merging, page 55](#) for more information.*

{Address} [n] [/]

The syntax **{Address} [n] [/]** can be used to select a full universe in patch.

- **[channel list] {Address} [n] [/] [Enter]** - changes the addresses of all the selected channels to a new universe while using the same offset.
- **{Address}[2] [/] [Copy To] [Copy To] <Address> [3] [/] [Enter]** - moves all channels with addresses in universe 2 to the same offsets in universe 3.
- **{Address} [n] [/] {Unpatch}** - unpatches all patched addresses in the selected universe.

Dimmer Doubling

You can patch channels in Ion to accommodate for dimmer doubling with Sensor dimmer racks. This is done using the softkeys available in patch (**{No Dim Dbl}**, **{A}**, and **{B}**).

For Example:

Let's assume you patch 96 channels of dimmers to addresses 1-96.

- **[1] [Thru] [9] [6] [At] [1] [Enter]**

Now you wish to dimmer double 1-12 of your Sensor+ rack and you want these to be channels 97-108. To patch this, press:

- **[9] [7] [Thru] [1] [0] [8] [At] [1] {B} [Enter]**

Channels 97-108 are patched to address 1-12 B, while channels 1-12 are now patched to address 1-12 A.

To remove the dimmer doubling from these addresses, you must first press **[Format]** to enter Address mode and then press:

- **[1] [Thru] [1] [2] {NoDimDbl} [Enter]**

Addresses 1-12 have been returned to single dimmer modes and channels 97-108 are now unpatched.

By default, doubled dimmers start with an offset network DMX address value of 20000. Therefore, in the above example, address 1B (channel 97) is actually controlled by network DMX address 20001. Address 2B is actually controlled by network DMX address 20002 and so on. This offset matches the default offset in CEM+ / CEM3 when configuring your Sensor dimmer rack for dimmer doubling. To change the default offset value, see [Show Settings, page 96](#).



Note: For Ion, dimmer doubling needs to be turned on per DMX port in the ECU. See ["Local DMX Outputs" on page 351](#).



Note: There is also a Dimmer Doubling setting for Net3 Gateways with DMX outputs. This is used with Sensor racks that are connected via DMX. The Gateway must be properly configured.

Moving and Copying Channels

Channels and their data can be moved from one location to another within patch. Channel data can be copied between different channels. You can also move the channel data from one channel to a different one.

- **[1] [Copy To] [Copy To] [7] [Enter]**

The second press of the **[Copy To]** key changes the command from copy to into move to.

This syntax will move the patch information for channel 1 to the patch for channel 3. All data in the show file that was stored at channel 1 is also move to channel 3.

To copy a channel to another location within patch:

- **[1] [Copy To] [2] [Enter]**

To copy a channel to another location within patch and all record targets in the show:

- **[1] [Copy To] [2] {Plus Show} [Enter]**

To copy a channel to another location with all record targets in the show but not the patch data:

- **[1] [Copy To] [2] {Only Show} [Enter]**

To copy on the notes and keyword fields from one channel to another:

- **[1] [Copy To] [2] {Only Text} [Enter]**

Swapping Channels

Channels can be swapped for each other in patch:

- **[1] {Swap} [2] [Enter]**

This syntax will replace channel 1's data with channel 2's and vice versa in patch and throughout the entire show.



Note: *Move To and Swap always impact the entire show.*

Unpatch a Channel

To unpatch a channel while in patch you can press:

- **[n] {Unpatch} [Enter]**

The **{Unpatch}** softkey, will reset all the properties of the channel to the default. This includes removing the device type if specified.

To retain all the elements of the channel, besides the address, you would instead use:

- **[n] [At] [0] [Enter]**

Unpatched channels may also have data stored.

Deleting Channels

It is possible to delete channels in patch. Deleting channels is different from unpatching in that deleted channels cannot be manipulated or have data stored for them. When deleted, the channel numbers will still be visible in the live/blind display, but the channel graphic will be removed from the display.

For Example:

To delete channels in the patch display, press:

- **[6] [Thru] [1] [0] [Delete] [Enter] [Enter]**

-or-

- **[Delete] [1] [Thru] [1] [0] [Enter] [Enter]**

Using {Offset} in Patch

Using the **{Offset}** feature in patch allows you to force a numerical offset between the starting address of channels in patch or for offsetting your channel selection. This feature is useful when you want to start your addresses at some known multiplier.

- **[1] [Thru] [5] [At] [1] {Offset} [3] [1] [Enter]** - fixtures will be patched with a patch address offset of 31 channels, allowing you to have additional space within the patch for a given fixture type regardless of configuration or personality.
- **[1] [Thru] [2] [0] {Offset} [2] [At] [1] {Offset} [2] [0] [Enter]**- selects every other channel in the list and patches them with an offset of 20 addresses.



Note:

For multiple parameter devices, Ion will automatically offset the addresses based on the fixture type.

Creating multi-part and compound channels

A multi-part channel is any channel that has more than one dimmer patched to it. A compound channel has multiple profiles patched to it that make up one channel, an example would be a dimmer with a scroller and auto-yoke. By default, Ion will add a part if you are trying to patch to a channel that has already been assigned an address.

To patch a multi-part channel in address format:

- **[5] [1] [3] [At] [8] [Enter]**

Assuming channel 8 was previously patched to an address, this will create a part 2 and address it at 513.

To patch a multi-part channel in channel format:

- **[9] [At] [5] [4] [0] [Enter]**

Assuming that channel 9 is already patched to an address, this will create a part 2 and address it at 540.

- **[8] [Part] [2] [At] [5] [1] [3] [Enter]**

This will create a part 2 for channel 8 and address it at 513. If you wish to patch by address while in the channel view, press:

- **{Address} [5] [1] [3] [At] [8] [Enter]**

This will perform the same action as the previous example, assuming channel 8 was previously patched to an address.

To select multiple parts for editing:

- **[1] [Part] [1] [Thru] [5]**

This is useful for deleting or assigning new addresses to existing parts.

To patch a compound channel in channel format:

- **[1] [Part] [2] [At] [5] {Type} <scroller profile>**

Creates a part 2 for channel 1 and assigns it the selected scroller profile. See [{Patch} Display and Settings, page 76](#) for more information on using **{Type}**.

Using the Scroller/Wheel Picker and Editor

The scroller and wheel picker allows you to choose a specific scroll, color wheel, gobo wheel, or effect wheel from standard manufacturers and associate them with fixtures. You may also create customized scrolls/wheels using the editor to match custom devices installed in your fixture.



Note: *Scrollers, color wheels, gobo wheels, and effect wheels can be created without first selecting or patching a fixture.*

Using the Picker

Default color and pattern media for the selected fixture, as determined in the fixture library, is displayed in the **{Attributes}** page. Only the media attributes that are available for the selected fixture will display.

In the image below, the selected channel is a Source Four Revolution[®] with a color scroller and two gobo wheels. If the selected channel included other wheels, each device would be represented in the display with a button.

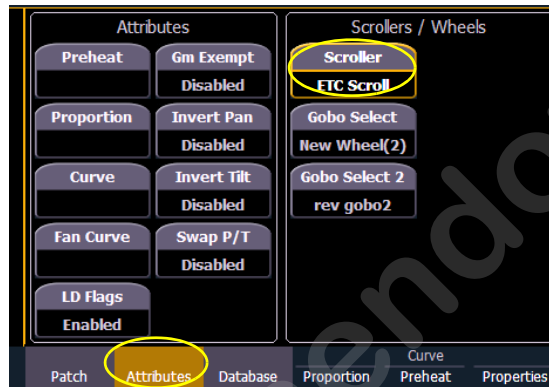

Select the desired attribute to open the picker

The picker displays on the left half of the CIA when you select the specific attribute (**{Scroller}**, **{Color Wheel}**, **{Gobo Wheel}**, or **{Effect Wheels}**). The picker displayed is specific to the selected attribute (the scroll picker will display when **{Scroller}** is pressed, the color wheel picker will display when **{Color Wheel}** is pressed, and so on).

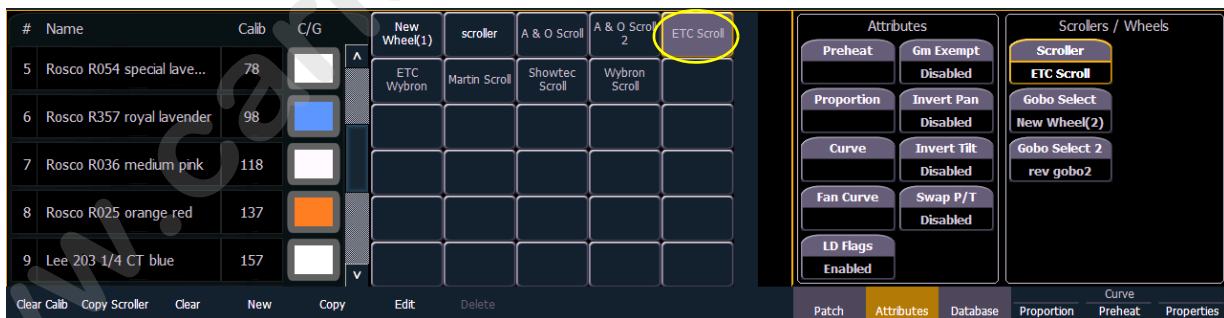

Select the scroll / wheel type.

The picker displays buttons for the standard scroll or wheel type of the selected channel. The default selection is the wheel as shipped from the manufacturer (derived from the fixture library). Displayed to the left of the standard scroll/wheel selection is a list of each color/gobo as they are installed in the selected device (frame by frame). When the color or pattern image is available, it will display next to the frame name.

In the above image, **{ETC Scroll}** is the default scroll for the selected ETC Source Four Revolution. The list of gel colors as they are installed in the scroll are displayed to the left with a color chip for easy reference. Selecting any other type, such as **{Martin Scroll}**, updates the frame list.

The softkeys displayed beneath the picker are **{Clear Calib}**, **{Copy Scroller}**, **{Clear}**, **{New}**, **{Copy}**, **{Edit}**, and **{Delete}**.

- **{Clear Calib}** - clears out the calibration data for the whole scroller wheel and returns to the wheel's default data.
- **{Copy Scroller}** - used to copy a scroller wheel and its calibration to another channel. See ["Scroller Calibration Column" on page 73](#).
- **{Clear}** - clears the selection type from the selected channel in the picker.
- **{New}** - creates a new scroll or wheel and provides additional softkeys to enable the Editor. See [Using the Editor](#) below.
- **{Copy}** - makes a copy of the currently selected scroll/wheel type, which can then be edited using the editor. See [Using the Editor](#) below.
- **{Edit}** - used to edit an existing scroll or wheel.
- **{Delete}** - used to remove the selected frame only from a scroll or wheel that you have created.

Using the Editor

The editor is used to create new or edit copied scrolls and wheels. While in the picker display, you can create a new scroll or wheel by pressing the **{New}** softkey or make a copy of an existing scroll or wheel by selecting the source, then pressing the **{Copy}** softkey.

The editor does not limit how many frames you can add to the scroll or wheel for the selected fixtures. Keep in mind that any fixture has its own limitations. For example, a Source Four Revolution color scroller is limited to 24 frames. If you have created a custom color scroll with 30 frames, the Source Four Revolution will only provide you access to the first 24 frames that you created. This applies to wheels as well.

When using the editor, the following softkeys are available for use:

- **{Insert}** - inserts a new frame above the selected frame.
- **{Delete}** - removes the selected frame.
- **{Edit}** - changes the selected frame.
- **{Invert}** - reverses the order of the frames.
- **{Done}** - completes the editing process.

Editing a copy of a scroll or wheel

If a copy has been made of an existing scroll or wheel, the copied scroll or wheel will display as **{New Wheel n}** before the standard manufacturer offerings. The frame list will include an exact duplicate of the copied selection.

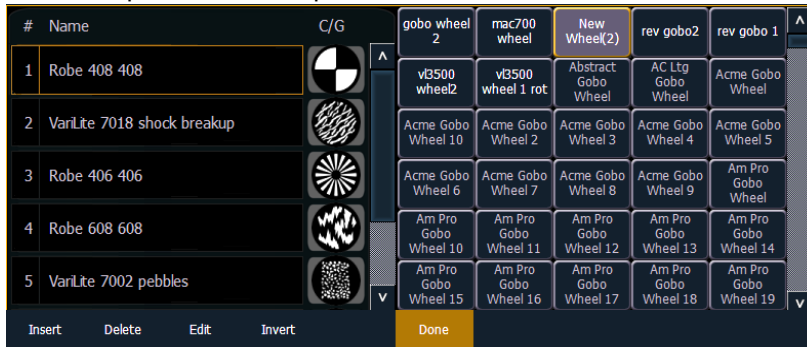

To make a change to a frame, first select the frame then press **{Edit}** to display the media selection. Or you can insert a new frame above a selected frame using the **{Insert}** softkey.

For example, to insert a new frame in between existing frames 2 and 3, select frame 3 and press the **{Insert}** key. The media selection will display.

Manufacturer List Manufacturer catalog Cataloged media

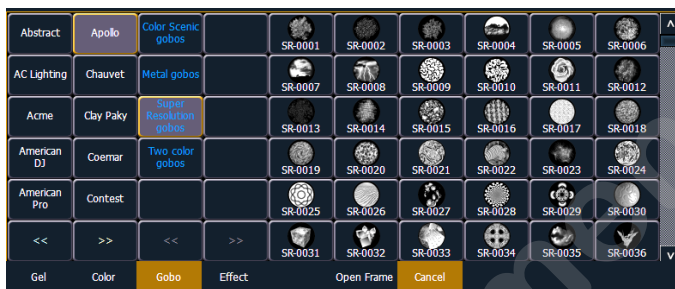

The media selection includes the following softkeys:

- **{Gel}**, **{Color}**, **{Gobo}**, and **{Effect}** - each will display available media selections as they are cataloged by the associated scroll or wheel manufacturers.
- **{Open Frame}** - places the frame in Open White.
- **{Cancel}** - cancels the media selection and returns to the frame editor.

When a manufacturer is selected from the list, the catalog selection changes to display only the selected manufacturer's offerings. When a specific catalog is selected, the media will display in the last three columns of the editor.

When you make a media selection, the display returns to the new wheel frame list where additional frames can be edited in the scroll or wheel.

Scroller Fan Curves

Curves can be applied to the scroller fan parameter allowing for the output of the fan to be controlled by the intensity of the channel. The curves available for this are the same used for intensity parameters and cues. [See "Storing and Using Curves" on page 277.](#)

To set a curve to a scroller fan, go to **Displays>Patch>Attributes>Fan Curve** for each scroller.

Calibrating a Scroller Using the Encoders

You can calibrate the center point of any frame in a scroller using the calibrate feature. Calibrating a scroller is normally done from the live display. You can also calibrate using the ML display. See [“Calibrating a Scroller Using the ML Display” on page 74.](#)



Note:

It is recommended that you calibrate your scroller frames starting with the last frame and working backward to the first frame. This will help ensure a complete and accurate calibration.

Calibration may need to be performed when you initially patch a scroller and may need to be adjusted through the course of operation as spring tension changes in a color scroller.

To calibrate a scroller:

- Step 1: Select the channel of the scroller you wish to calibrate.
- Step 2: Press the **[Color]** encoder button. Multiple presses may be required before the scroller encoder is visible in the encoder LCD.
- Step 3: Use the encoder to move all the way to the last frame of the scroller.
- Step 4: If you are in course mode, press the encoder to switch to “Fine” mode. The **{Calibrate}** touchbutton will appear as one of the scroller buttons in the LCD.
- Step 5: Continue adjusting the frame in fine mode until the frame is centered in the desired position.
- Step 6: Press **{Calibrate}** in the encoder LCD. The new center position is now stored for the selected channel.
- Step 7: Press **{Last}** in the encoder LCD to move to the center point of the previous frame.
- Step 8: Visually verify if the center point of the new frame is accurate. If it is, press **{Last}** again to move to the previous frame in the scroll. If not, follow the calibration procedure again.
- Step 9: Repeat steps 4-8 until you have calibrated all of the frames

Scroller Calibration Column

Calibration information will be displayed in the scroller calibration column.

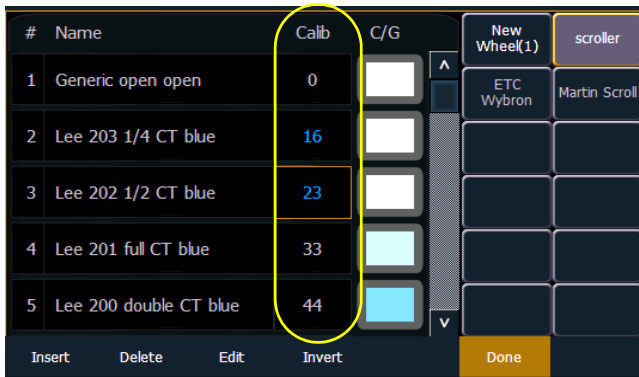

#	Name	Calb	C/G	New Wheel(1)	scroller
1	Generic open open	0		ETC Wybron	Martin Scroll
2	Lee 203 1/4 CT blue	16			
3	Lee 202 1/2 CT blue	23			
4	Lee 201 full CT blue	33			
5	Lee 200 double CT blue	44			

Values in gray are default data, and the values in blue are calibrated data.

The displayed calibration information is the DMX address that puts the frame into its center position. Information in the calibration column can be manually edited by clicking on it and typing in a new DMX address.



Note:

Calibration data will only be applied to scroller wheels that are assigned to a channel. Data will not be displayed when viewing a wheel with an empty command line.



Note:

Calibration data can be returned to its default by clicking on the data and pressing **[Clear]**. If you are entering in new data and hit **[Clear]**, the data will return to the default and not any previously calibrated data.

Pressing the softkey **{Clear Calib}** will clear out the calibration data for the whole scroller wheel, returning it to the default data.

Scroller wheels and their calibration data can be copied to other channels.

- **[1] {Copy Scroller} [2] [Enter]** - copies the scroller and calibration data from channel 1 to channel 2.

Scrollers that have calibrated data will display a “~” after their name.

The **{Calibrate}** button will now only appear on scroller parameters that are currently not at the center of a frame.

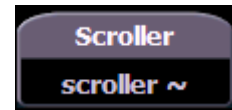

Calibrating a Scroller Using the ML Display

You can calibrate the center point of any frame in a scroller using the calibrate feature. This will ensure that color scroll frames will be centered over the aperture of the fixture when you advance a color scroll frame-by-frame. You can do this using the ML Controls display.



Note:

It is recommended that you calibrate your scroller frames starting with the last frame and working backward to the first frame. This will help ensure a complete and accurate calibration.

Calibration may need to be performed when you initially patch a scroller and may need to be adjusted through the course of operation as spring tension changes in a color scroller.

To calibrate a scroller:

- Step 1: In the Live display, select the scroller channel.
- Step 2: Use the **[ML Controls]** key to open the ML Controls display.
 - The color category will display automatically with the Hue and Saturation encoders and a frame picker.
- Step 3: To begin calibrating, click on the **{Scroller ::}** button. The scroller encoder will be displayed.
- Step 4: Use the scroller encoder to adjust the centerpoint of a frame. It is recommended that you start with the last frame in the scroll.
- Step 5: When the frame is centered, click **{Calibrate}**.
- Step 6: Repeat for any remaining frames that need to be calibrated.

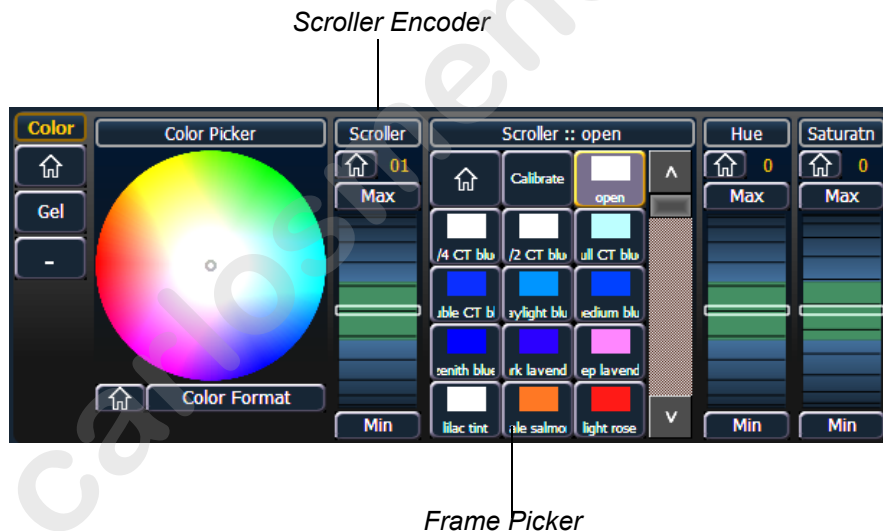

Patching Moving Lights, LEDs, and Accessories

The process of patching moving lights requires more detail than patching a dimmer. Specific information is required for more advanced control of the features offered by moving lights.

It is recommended that when patching moving lights, LEDs, and accessories that you work in patch by channel mode.

After you have entered the channel number, click **{Type}**. You will then select a device type from the fixture library.

Press **{Manfctr}** from the CIA to display the fixture library. The two columns on the left are pageable and show manufacturer names. Use the arrow buttons to scroll the list of manufacturers. Selecting a manufacturer repaints the device columns with all devices from that manufacturer that are available for patching.

Scroll through the device list and make your selection. If a fixture has multiple modes, clicking on its name will open a list of available modes. After the selection is made, the fixture or device type will be placed on the command line after the channel number and displayed in the box beneath the **{Type}** button.

Notice the three softkeys **{Favorites}**, **{Manfctr}**, and **{Add Favorite}** located beneath the CIA.

{Favorites} provides you with the option of showing only the library of fixtures or devices that are already patched in the show, your favorites, and Ion's default devices. **{Manfctr}** shows all fixtures or devices available in the library sorted by manufacturer.

{Add Favorite} will add a fixture or device to your favorites list. If you want to delete a fixture or device from the favorites list, click **{Edit}** while in the favorites display. Select the device you wish to remove and click **{Delete}**.



Press **[At]** and then enter a starting address for the selected channel or group of channels. The desk will automatically offset addresses based on the fixture type selected.

To select a device interface (optional), click **{Interface}**. See [“Protocols” on page 221](#).

Click the **{Attributes}** softkey to set detailed moving light attributes. The following buttons may be available on this page depending on the device selected: **{Preheat}**, **{Proportion}**, **{Curve}**, **{Fan Curve}**, **{LD Flags}**, **{GM Exempt}**, **{Invert Pan}**, **{Invert Tilt}**, **{Swap P/T}**, **{Scrollers}**, **{Gobo Wheels}**, **{Color Wheels}**, and **{Effect Wheels}**. See [“{Attribute} Display and Settings” on page 78](#).

If your moving light includes parameters such as a color scroller or gobo wheel and you have custom gels or non-standard patterns installed, use the Scroller/Wheel Picker and Editor to modify the device patched. The more specific your patch data (including accurate colors and patterns), the more detailed programming and operating will be. See [“Using the Scroller/Wheel Picker and Editor” on page 68](#).

Display Pages in Patch

Softkeys available for use while in patch include **{Patch}**, **{Attributes}**, and **{Database}**. Pressing any of these softkeys opens a paged view of the patch display and redraws the CIA to an expanded view of fields related to the selected page.

When creating and editing your patch, page through each of these softkeys individually to enter more specific data about your selected device.

{Patch} Display and Settings

When patch is opened, Ion defaults to this display. It provides access to data input fields that you may use to define devices in your lighting system.

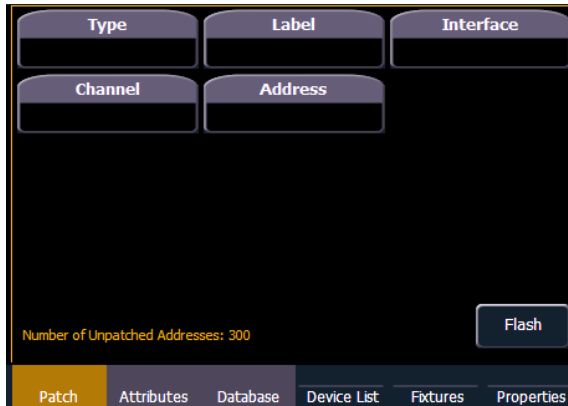

- **{Channel}** - In the patch display, all channels are displayed in numerical order. When multiple devices are patched to the same channel, the channel number is only displayed in the first row, additional devices are indicated with part extensions (example P2) on the next row of the table.
 - Select the channel number using the control keypad or the direct selects.
- **{Type}** - Ion defaults to patching dimmers. To specify a specific device type for the selected channel, press the **{Type}** button from the CIA.
 - The two columns on the left side of the CIA are pageable and show manufacturer names. The four columns to the right of the manufacturer's list are pageable devices that are available from the selected manufacturer for patching.
 - Selecting a specific manufacturer repaints the display with all devices that are available from that manufacturer. After you select a device, the fixture/device type appears in the command line, in the **{Type}** box in the CIA, and in the "Type" field for that channel in the patch display.
- **{Label}** - An optional user-defined label. You can use the **[Label]** key to display the virtual PC keyboard on the CIA. Pressing **{Label}** or **[Label]**, after a label has already been assigned, will display the label on the command line for editing purposes. Pressing **[Label [Label]** will delete the text.
 - **[1] [At] [5] [Label] <S4 house right> [Enter]** - patches channel 1 to output 5 and labels channel it "S4 house right".

- **{Address}** - A required entry field for any device. You may use **[At]** instead of the **{Address}** button.
 - Use the keypad to define the starting address for the device (from 1 to 65536) or a port and offset value.
 - You may enter a start address without defining an end address. Ion will draw this information from the library data. If you wish to leave a larger output gap than required by the library, use **[Offset]**. See [Using {Offset} in Patch, page 67](#).
 - If you specify a start address that conflicts with other channels already patched, the conflicting channels will be unpatched after a confirmation is provided by the user.
- **{Interface}** - An optional field used to specify what network interfaces should be used for the output. When the field is left blank, the default data output is used as selected in the **{Network}** and **{Local I/O}** sections of the ECU. For more information about setting defaults see [Output Protocols, page 342](#) and [Local DMX Outputs, page 351](#). The interface options available are sACN, Net 2- EDMX, ArtNet, Avab UDP, and Local DMX, depending on what has been enabled in the **{Network}** and **{Local I/O}** sections of the ECU for the desk. If an output option is not enabled, it will not appear in the **{Interface}** list.
- **{Flash}** - will bring a channel or address to full, and then every other second the level will move to 15%. That will hold for 1 second, and then the level will return to full. The channel or address will keep flashing until either the command line is cleared or **{Flash}** is selected again.

{Attribute} Display and Settings

The **{Attributes}** page provides you with optional fields for additional information and details about the configuration of your rig. Attribute settings include **{Preheat}**, **{Proportion}**, **{Curve}**, **{Fan Curve}**, **{LD Flags}**, **{GM Exempt}**, **{Invert Pan}**, **{Invert Tilt}**, and **{Swap P/T}**.

When the selected device includes a color scroller, a **{Scroller}** button will be displayed in the CIA, when the selected device includes a color wheel, a gobo wheel, and/or effect wheel, **{Color Wheel}**, **{Gobo Wheel}**, and/or **{Effect Wheel}** buttons will appear.

Press the desired attribute button and use the keypad to set the attribute value.

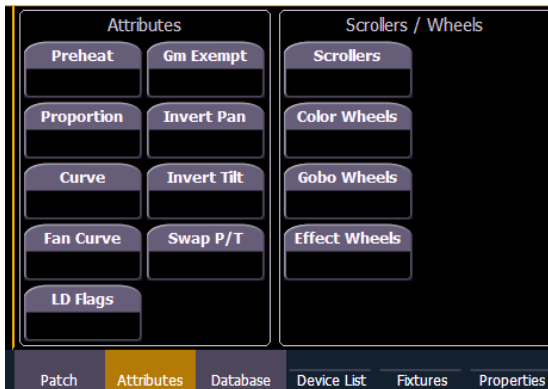

- **{Preheat}** - This field allows you to specify an intensity value to preheat incandescent filaments. When a preheat flag is applied to a cue, any channels that are fading from zero to an active intensity and have been assigned a preheat value in patch will preheat in the immediately preceding cue.
 - **[1] {Preheat} [0] [3] [Enter]** - channel 1 is assigned a patched preheat value of 3%.
The preheat flag is applied to a cue as an attribute when the cue is recorded.
- **{Proportion}** - An attribute to set a modifier for the intensity of the device. If the patch limit is set at 90% (for example), the actual output will always be 10% lower than the specified intensity parameter, as impacted by the various playbacks or submasters. This value is set numerically in a range of 0% to 200%.
 - **[1] {Attributes} {Proportion} [1] [2] [5] [Enter]** -applies a 125% proportion to channel 1.
 - **[1] {Attributes} {Proportion} [Enter]** - removes the applied proportion from channel 1.
- **{Curve}** - Used to assign a curve to an address in patch. In patch, curve is applied to intensity parameters only.
 - From channel view:
 - **[1] {Curve} [4] [Enter]** - applies curve 4 to the intensity parameter of channel 1.
 - **[2] [Part] [3] {Curve} [3] [Enter]** - applies curve 3 to the intensity assigned to channel 2, part 3.
 - From address view:
 - **[3] {Curve} [3] [Enter]** - assigns curve 3 to address 3.
 - **[3] [/] [2] {Curve} [4] [Enter]** - assigned curve 4 to universe 3, address 2.
- **{Fan Curve}** - Used to assign a curve to the scroller fan parameter, which allows for the output of the fan to be controlled by the intensity of the channel. Curves available for this are the same used for intensity parameters and cues.



Note:

*When **{Curve}** or **{Fan Curve}** is pressed, a list of the available curves will be displayed. Clicking on an available curve will assign it.*

- **{LD Flags}** - This field allows channels to contribute to live and dark move flags in the playback status display. Disabling will prohibit those channel moves from contributing to the live and dark move flags. This is enabled by default.
- **{GM Exempt}** - Used to exempt channels from grandmaster, blackout, rem dim, and go to cue 0 operations.
- **{Invert Pan} {Invert Tilt}** - A moving light attribute used to invert the output of pan, tilt, or both. Select either the **{Invert Tilt}** or the **{Invert Pan}** button on the CIA.
 - **[2] {Attributes} {Invert Pan}** - inverts the output of the pan parameter on channel 2.
- **{Swap P/T}** - A moving light attribute used to exchange pan and tilt levels. Select the **{Swap}** button on the CIA.
 - **[2] {Attributes} {Swap}** - swaps the pan and tilt parameters for channel 2.
- **{Scrollers}** - An attribute used to change the scroll loaded in a scroller or moving light. Select the **{Scrollers}** button on the CIA to display the scroller picker and the scrolls available for your device. *See "Using the Picker" on page 68.*
 - **[2] {Attributes} {Scrollers}** - opens the Scroller Picker in the CIA for scroll selection for channel 2.
- **{Color Wheels}** - An attribute used to change the color wheel loaded in a moving light. Select the **{Color Wheels}** button on the CIA to display the wheel picker with the options available for your device. *See "Using the Picker" on page 68.* "More" as shown in the patch display, indicates additional parameter properties are available for the selected device, such as the color and gobo wheels.
 - **[4] {Attributes} {Color Wheels}** - selects channel 4 and opens the wheel picker in the CIA for color wheel selection.
- **{Gobo Wheels}** - An attribute used to change the gobo wheel loaded in a moving light. Select the **{Gobo Wheels}** button on the CIA to display the wheel picker with gobo options available for your device. *See "Using the Picker" on page 68.*
 - **[3] {Attributes} {Gobo Wheels}** - selects channel 3 and opens the Wheel Picker in the CIA for gobo wheel selection.
- **{Effect Wheels}** - An attribute used to change the effect wheel loaded in a moving light. Select the **{Effect Wheels}** button on the CIA to display the wheel picker with the options available for your device. *See "Using the Picker" on page 68.* "More" as shown in the patch display, indicates additional parameter properties are available for the selected device, such as the color and gobo wheels.
 - **[5] {Attributes} {Effect Wheels}** - selects channel 5 and opens the wheel picker in the CIA for effect wheel selection.

{Database} Display and Settings

The **{Database}** page provides you with additional fields for entering information that can be used by the “Query” function. These fields include **{Notes}** and **{Text 1}** through **{Text 4}**. Clicking on **{Text 1}** through **{Text 4}** will open up a display for selection of keywords. It will display keywords that were already created as well as showing an option for creating new keywords. Clicking on **{New Keyword}** will display an alphanumeric keyboard for entering in a new keyword

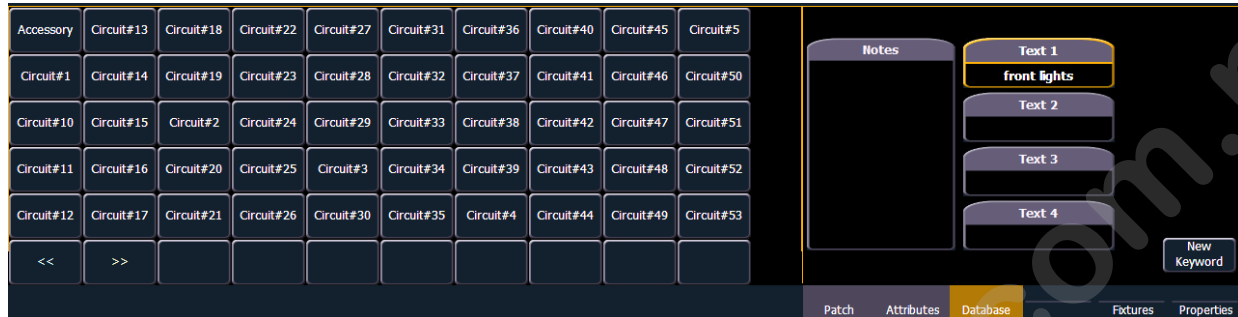

- **{Text}** - Text fields are used to provide up to four keywords about any channel or group of channels. These fields can be anything that you think is important about a channel, such as its location (FOH), an attribute of it (wash, spot) or other characteristics of the channel (such as gel R80). You may use the virtual keyboard in the CIA, or an external keyboard, to provide up to 30 characters of key words about the device.
 - **[5] {Database} {Text 1} < FOH right> [Enter]** - adds text to channel 5.
- **{Notes}** - Provides you the ability to attach a text note to a channel or group of channels. Select the **{Notes}** button on the CIA to display the virtual keyboard. You may type a label or any length of note regarding your channel in this space.
 - **[5] {Database} {Notes} <this fixture is a backup to channel 15 for front of house right / new lamp installed on 10/4/06> [Enter]** - adds a note to channel 5.

Adding Keywords in Patch

If you plan on being able to query channels based on a keyword association, the keyword must be defined in patch.

To enter a keyword for a channel:

- Step 1: Press **[Displays]**, to the right of the CIA.
- Step 2: Press **{Patch}** at the bottom of the CIA.
- Step 3: Press **{Database}**.
- Step 4: Select a channel or range of channels in the command line.
- Step 5: Touch one of the **{Text (1-4)}** touchbuttons in the CIA to specify which keyword you are entering. A list of previously defined keywords will be posted. Select from these or press **{New Keyword}**. A virtual alphanumeric keyboard will appear.
- Step 6: Type the keyword or words you wish to use.
- Step 7: When finished, press **[Enter]**.

Once keywords have been created, they will appear in the keyword section of the CIA when a query is performed. For more information on keyword queries see [Using {Query}, page 232](#).

Deleting Keywords from the Database

Keywords can be deleted from any of the four text fields in the database. To delete a keyword from the entire database, you would use the following syntax:

- ***[Delete] {Text1} <orange> [Enter] [Enter]***

This will delete orange anywhere it was used in any text field of any channel.

To just delete a keyword from a specific channel, you would use the following syntax:

- ***[1] {Text1} [Enter]***

That would delete the text from channel 1's first text field only. If you wanted to delete the second text field, you would select **{Text2}** and so on.

Using Device List

The Device List is used to discover, configure, and monitor compatible Remote Device Management (RDM) and network devices. RDM allows for bi-directional communication between a RDM compatible device, such as a lighting fixture, and your desk.

Two lists, dimmer and RDM, make up the device list.

The dimmer list is the area of patch that handles setting up dimmer feedback from CEM+, CEM3, and FDX 2000. You can also do some configuration of dimmers from this list.

The RDM List is the area of patch that handles RDM feedback with devices. You can also do some configuration of devices from this list. Once RDM compatible devices have been patched, they keep communicating with the desk to allow you to know when things like blown lamps happen or if a device goes offline for some reason. [See “RDM Device List” on page 84.](#)

The Device List displays all discovered devices during the current session and all devices that have been stored in the show file.



Note: Desks only support RDM devices that are connected through an external ACN gateway. Supported gateways are the ETC Net3 4 or 2 port Gateways. Gateways need to be running version 5.1 or newer.

Dimmer List for CEM+, CEM3, and FDX 2000



Note: For Dimmer Feedback, these software versions are required: CEM+ v3.0 and newer, CEM3 v1.3.1 and newer, and FDX v3.4.0 and newer.

To use the Dimmer Feedback area of the Device List, you must first enable feedback. In the network tab of the ECU, when using CEM+ or CEM3, make sure **{Sensor Feedback}** is enabled, or when using FDX 2000, make sure that **{FDX}** is enabled. The default setting is disabled for both. [See “Interface Protocols” on page 343.](#)

Open the Dimmer Feedback display while in the patch display by pressing **{Device List}> {Dimmers}**. When the dimmer list is opened, the dimmers will be displayed in Patch by Address mode.

The screenshot shows the 'Patch (Dimmers)' window with a table of dimmer properties. The table has columns for Address, Chan, Label, System, Rack, Lug, Module Type, Firing Mode, Control Mode, Curve, and Loads. The 'Loads' column is currently empty. The table contains 19 rows of data, all with 'Unnamed' labels and 'D20' module types.

Address	Chan	Label	System	Rack	Lug	Module Type	Firing Mode	Control Mode	Curve	Loads
4		Unnamed	0	1	4	D20	Normal	Dimmable	Mod Square	
5		Unnamed	0	1	5	D20	Normal	Dimmable	Mod Square	
6		Unnamed	0	1	6	D20	Normal	Dimmable	Mod Square	
7		Unnamed	0	1	7	D20	Normal	Dimmable	Mod Square	
8		Unnamed	0	1	8	D20	Normal	Dimmable	Mod Square	
9		Unnamed	0	1	9	D20	Normal	Dimmable	Mod Square	
10		Unnamed	0	1	10	D20	Normal	Dimmable	Mod Square	
11		Unnamed	0	1	11	D20	Normal	Dimmable	Mod Square	
12		Unnamed	0	1	12	D20	Normal	Dimmable	Mod Square	
13		Unnamed	0	1	13	D20	Normal	Dimmable	Mod Square	
14		Unnamed	0	1	14	D20	Normal	Dimmable	Mod Square	
15		Unnamed	0	1	15	D20	Normal	Dimmable	Mod Square	
16		Unnamed	0	1	16	D20	Normal	Dimmable	Mod Square	
17		Unnamed	0	1	17	D20	Normal	Dimmable	Mod Square	
18		Unnamed	0	1	18	D20	Normal	Dimmable	Mod Square	
19		Unnamed	0	1	19	D20	Normal	Dimmable	Mod Square	
20		Unnamed	0	1	20	D20	Normal	Dimmable	Mod Square	
21		Unnamed	0	1	21	D20	Normal	Dimmable	Mod Square	
22		Unnamed	0	1	22	D20	Normal	Dimmable	Mod Square	

Ion will display the following information that it receives from the dimmers:

- Address
- Channel
- Label
- System
- Rack
- Lug
- Properties
 - Module Type
 - Firing Mode
 - Control Mode
 - Curve
- Loads
 - Recorded Loads



Note: *The System ID number from CEM3 is not currently supported.*



Note: *Rack numbers and dimmer numbers need to be unique for Ion to properly recognize them. For CEM+, dimmers also need to be patched to different sACN addresses.*

With a dimmer or dimmers selected, you can edit various dimmer settings in the property view, which will display in the CIA. Items with a caret (>) are editable. When multiple dimmers are selected together for editing, an "*" will show for data that is different between the selected dimmers.

Dimmer Feedback	Value
Label	*
Module Type	D20
System/Rack/Lug	*
Rack Dimmer Level	0%
Rack Dimmer Source	Streaming ACN
Recorded Load	Not Recorded
Actual Load	0 Amperes
Firing Mode	> Normal
Control Mode	> Dimmable
Curve	> Mod Square
Threshold	> 1%

FDX dimmers will not display data for the following:

- Recorded Load
- Actual Load
- Rack Dimmer Source
- Threshold
- Scale Minimum
- Preheat Enable
- Preheat Timing
- AF Enable



Note: *When dimmers are discovered, they are not automatically attached to patched channels in Ion; you must attach a dimmer to a channel. See [“Patching Discovered Dimmers and RDM Devices”](#) on page 86.*

RDM Device List

Before you can start using the RDM Device List, you must first enable **{RDM}** in the network tab of the ECU. By default RDM is disabled. See *"Interface Protocols" on page 343*. RDM must also be enabled on the DMX ports of the Gateway. The Gateway needs to be running version 5.1 or newer.

Open the RDM Device List while in the patch display by pressing **{Device List}> {RDM}**.

You will need to make sure that **{Device Discovery}** is enabled.

{Device Discovery} is disabled by default. The **{Device Discovery}** option will not display if **{RDM}** is disabled in the ECU.



Note: ***{Device Discovery}** will automatically disable when you leave the patch display.*

When the RDM device list is opened, the devices will be displayed in Patch by Address mode. At the top of the list is a RDM indicator. This indicator shows incoming and outgoing RDM traffic.

The screenshot shows the "Patch (RDM)" interface with a table of discovered devices. The table has columns for Address, Chan, Label, Manufacturer, Model, Footprint, and Eos Type. The "RDM Activity Indicator" is visible at the top right of the table area.

Address	Chan	Label	Manufacturer	Model	Footprint	Eos Type
1-3	P1	There 1	ETC	Source 4 Daylight	3	No RDM Data Available
	P2	Here 1	ETC	Source 4 Daylight	3	No RDM Data Available
21-25	P1	Here 2	ETC	Desre Vvvd 40	5	No RDM Data Available
	P2	There 2	ETC	Source 4 Tungsten	3	No RDM Data Available
41-50		Here 3	ETC	Source 4 Lustr	10	General
61-74		Here 4	ETC	Desre Vvvd 40	14	No RDM Data Available
81		Here 5	ETC	Source 4 Tungsten	1	No RDM Data Available
101-102		Here 6	ETC	Desre Tungsten 40	2	No RDM Data Available
121		Here 7	ETC	Desre Tungsten 40	1	No RDM Data Available
141-154		Here 8	ETC	Desre Vvvd 40	14	No RDM Data Available
161-163		Here 9	ETC	Desre Daylight 60	3	No RDM Data Available
201-210		Here Side 10	ETC	Source 4 Lustr	10	No RDM Data Available

Ion will display the following information that it receives from the RDM devices:

- Address (a part will be added if multiple devices are discovered with the same address)
- Channel
- Label
- Manufacturer
- Model
- Footprint

Ion will also display what personality from the Ion library the device matches in the Ion Type column. This information will not display until you first select the device. Once the device has been selected for the first time, Ion will extract the type information from the device and display it.

The following messages may display in the Ion Type column:

- No RDM Data Available - no model specific RDM data has been extracted from the device.
- Extracting RDM Commands - currently getting the command data from the device.
- Extracting RDM Fixture - currently getting the data required to create a fixture definition for the device.
- Extracting RDM Sensors - currently getting the sensor definitions from the device.
- Offline - no model specific RDM data has been extracted from the device and it is now offline.

With a device or devices selected, you can edit various device settings in the property view, which will display in the CIA. Items with a caret (>) are editable. When multiple devices are selected together for editing, an "*" will show for data that is different between the selected devices.

Device Property	Value
Device Model Description	*
Manufacturer Label	ETC
Device Label	> *
Software Version Label	1.3.0.9.0.07
DMX Personality	> *
DMX Start Address	> *
Identify Device	> Off
LED Curve	> *
LED Strobe	> On
LED Output Mode	> Regulated
LED Red Shift	> Off

The following buttons will also display in the property view:

- **{Device Properties}** - opens the properties list for the selected RDM device.
- **{Sensors}** - displays if the selected device has sensors. Pressing **{Sensors}** will open the sensors list.
- **{Lamp Controls}** - displays if the selected device has lamp controls. Pressing **{Lamp Controls}** will open the lamp controls list.
- **{Ignore Errors}** - when enabled, errors messages will not display in the live/blind displays. They will still display in about and the properties display in patch.
- **{Reload RDM Data}** - deletes the fixture data from the desk and reloads it from the device.
- **{Flash}** - triggers the identity function of the RDM device. The identity function may defer between different manufacturers' devices. For example, Wybron scrollers identify by wiggling their gel back and forth.
- **{!}** or **{?}** - displays if selected device has errors. Pressing **{!}**/**{?}** will open the error list.



Patching Discovered Dimmers and RDM Devices

When dimmers/devices are discovered, they are not automatically attached to any patched channels in Ion. If you want the benefits of dimmer or RDM feedback, you must attach a dimmer or device to a channel.

If you patch a dimmer/device's address to a channel, while in the device list display, the dimmer/device will be automatically attached to that channel. However, if you patch outside of the device list, you will need to **{Attach}** the device to the channel.



Note: *If the dimmer/device's address is not yet used in the patch, it is easiest to patch the address to a channel in the dimmer list or device list screen.*

<Chan> [X] {Attach} or **<Address> [X] {Attach}** will link that channel/address in patch and the dimmers/devices at that address.

When a channel number is attached to a dimmer/device, by patching it or using **{Attach}**, the channel's fixture type is changed to the dimmer or device fixture type.

The advantages of attaching a dimmer to a channel are:

- The desk warns you when a channel's attached dimmer has an error or is offline.
- Items that are attached between patch and the device list will display a caret (>) beside their channel/address in patch.

The advantages of attaching a device to a channel are:

- Its fixture type is copied to the channel.
- The desk warns you when a channel's attached device is offline or has an error.
- The device will always appear in the device list display, even if the device is offline.
- Items that are attached between patch and the device list will display a caret (>) beside their channel/address in patch.

Errors and Warnings

One of the advantages of using dimmer and RDM feedback is error and warning reporting. If something happens with a patched and attached dimmer/ device, you will be notified in live, patch, and about.

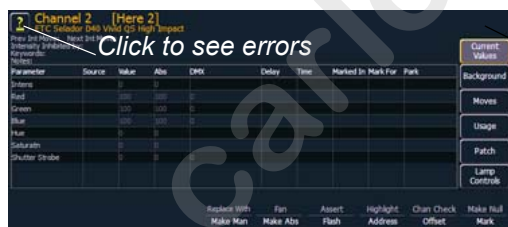

About

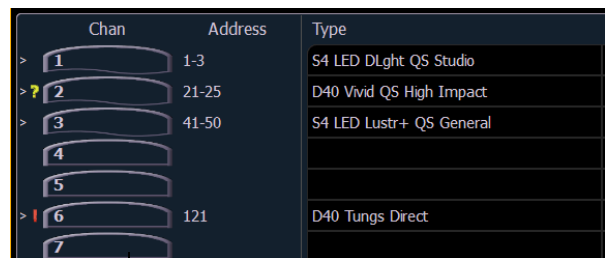

Patch



About Errors



Live

The notifications you can see are:

- A red "!" means that the dimmer/ device has errors, such as overtemp, breaker trip, and lamp out.

- Yellow “?” means that the dimmer/ device has a warning message. Warning messages can include:
 - Multiple devices’ addresses overlap
 - Multiple devices of different devices at this address
 - Patched fixture type mismatch
 - Patched fixture address mismatch
 - Offline

Detaching Devices

Pressing **{Attach}** twice will post the **{Detach}** command.

<Chan> [X] {Attach} {Attach} or **<Address> [X] {Attach} {Attach}** will remove the link between that channel/address and the device at that address.

Clearing the Patch

You can clear the patch entirely by accessing the clear functions from the browser. Select **{Clear}** from the main browser menu. The clear functions window will open in the CIA.



To clear the patch, click **{Clear Patch}**. A confirmation is required before the patch will be cleared.

To exit the clear functions screen without clearing, press the **[Displays]** key at any time or select a clear button and then select **{Cancel}** from the confirmation screen.

Reset Patch

You can use **{Reset Patch}** to clear out your patch, and set it to a 1-to-1 patch.

Fixture Creator

Ion provides you with the ability to create your own fixture type within patch and store it with your show file. You can name the fixture, assign all necessary parameters, define the address and operational range of those parameters, and set lamp controls.

The fixture creator is accessible from patch. Once a fixture has been created, it is stored in the show file. It is *not* added to the fixture library. If you want to use the created fixture in another show file, you will need to use merge. [See “Merging Custom Fixtures into a New Show File” on page 92.](#)

To open the fixture creator:

- Step 1: Press **[Displays]> {Patch}** to open the patch display.
- Step 2: Press the **{Fixtures}** softkey. This will open a list displaying those same fixtures that are currently patched. This is the fixture creator.

Number	Type / Label	Number Of Parameters	Remote Dimmer
1	Color Block DB4 M1	13	
2	Coloram 2 Scroller	3	
3	Dimmer	1	
4	Mac 2000 Profile 168	27	
5	Mac 700 Profile Basic	27	
6	Revolution RWM/RWM	20	
7	S4 LED Lustr+ QS Stage	13	
8	Sensor Dimmer	1	
9	VL3500 Spot	32	

New Copy Delete Update Lib Return

Creating a New Fixture

New fixtures are created from the fixture creator list in the CIA (see above). You can either create a new fixture, or copy an existing fixture to edit. [See “Copying a Fixture” on page 92.](#)

To create a new fixture, press **{New}**. A new fixture will be added to the fixture list.

Name New Fixture

Once the new fixture appears in the list, it is recommended that you name the fixture you are about to create.

To name a fixture in the creator list:

- Step 1: Use the **[Page]** keys, mouse, or touchscreen to select the new fixture.
- Step 2: Press **[Label]** or **{Type}**. You can press **[Label]** twice to clear the name. The virtual keyboard will open in the CIA.
- Step 3: Enter the desired name for the new fixture on the virtual (or attached alphanumeric) keyboard.
- Step 4: Press **[Enter]**. The name will appear in the “Type” column for the new fixture.

Add parameters

After naming the fixture, you can specify which parameters the new fixture contains.

To add parameters to a new fixture:

- Step 1: Use the **[Page]** keys, mouse, or touchscreen to select the new fixture.

Step 2: Press **{Edit}**. That fixture will open in a new display in the CIA.

new fixture (1)								
Number	Parameter	Size	DMX	LDMX	Home	Snap	Ranges	
1	Intens	8BITS	1		0		1	
2	Pan	8BITS	2		0		1	
3	Tilt	8BITS	3		0		1	
4	Width	8BITS	4		0		1	
5	Height	8BITS	5		0		1	
6	Z	8BITS	6		0		1	
7	Hue	8BITS	7		0		1	
8	Saturation	8BITS	8		0		1	
9	Cyan	8BITS	9		255		1	

New Insert Delete Parameters Size Remote Dim Ranges Lamp Ctrls Snap Return

Step 3: Determine the total number of parameters that your fixture has. Do not count 16-bit channels as two channels, this will be done in a later step.

Step 4: Press **{New}** to add parameter slots. Repeat this step until you have as many slots as are required by the number determined in step 3.



Note:

*When **{New}** is pressed, the parameter slot will appear in the list with a default name in the "Parameter" column. You may disregard these default parameters as you will redefine the designations in a later step.*

Step 5: Use the **[Page]** keys, mouse, or touchscreen to navigate to any parameter slots that you wish to alter the default parameter designations for.

Step 6: Click on the slot or press **{Parameters}** to open a list of touchbuttons that represent all of the available parameters.

All	Form	Intens	Z	Yellow	Brightness	Strobe Duration	Amber	Warm White	Animation Wheel Mode	Frame Angle	Blue Adjust	Scale X	Keystone Y1	Keystone X4
Intensity	Shutter	Pan	Hue	Red	Scroller Fan	Global Pan	Red Orange	CTB	Iris	Barndoor	In Point 1	Scale Y	Keystone X2	Keystone Y4
Focus	Control	Tilt	Saturation	Green	Flow Rate	Global Tilt	Indigo	CTC	Diffusion	Fresnel	Out Point 1	X Position 1	Keystone Y2	Layer Effect Parameter
Color		Width	Cyan	Blue	Enable	Pitch	White	CTO	Edge	Red Adjust	Playback Speed 1	Y Position 1	Keystone X3	Media Level
Image		Height	Magenta	Scroller	Strobe Mode	Position Blink	Cool White	Gobo Offset Amplitude	Zoom	Green Adjust	Z Rotate	Keystone X1	Keystone Y3	Playback Mode 1
<<	>>	<<	>>											

a: Use the **{>>}** and **{<<}** buttons to scroll through the available parameters (in alphabetical order).

The touchbuttons on the left side of the CIA can be used to speed your search. You may press them to see only parameters that fall into the specific categories of **{Intensity}**, **{Focus}**, **{Color}**, **{Image}**, **{Form}**, **{Shutter}**, or **{Control}**. **{All}** returns you to the complete list of parameters.

b: Use the parameter category buttons on the left of the CIA to expedite searching for a particular parameter.

Step 7: Press the touchbutton for the desired parameter in the CIA.

Step 8: Repeat steps 5-6 until you have entered all of the required parameters for the new fixture.

If you are missing a parameter slot: At any point you can use the **[Page]** keys and **{Insert}**, to insert a parameter slot above the selected one.

If you want to remove a parameter: you can use the **[Page]** keys and **{Delete}**, to remove a parameter from the list.

Define Parameters

Once you have added and specified all of the parameters for the new fixture, you can now define the address requirements, size, and ranges for each of them.

To define the size (8-bit or 16-bit) of any parameter:

- Step 1: Use the **[Page]** keys to navigate to any parameter that you wish to alter the size of. The system defaults to 8-bit for any new parameter.
- Step 2: When selected, press **{Size}**. This will toggle the parameter from 8-bit to 16-bit. If 16-bit is selected, the system automatically applies a value in the “LDMX” column. This value can be altered (see below).

To define the DMX address of any parameter:

You can alter the default DMX address assigned to any parameter in the list. This is not the actual address that will be used when patched, but rather it is the order of address for the parameter relative to the other parameters in the fixture.

- Step 1: Use the **[Page]** keys to navigate to the “DMX” column of the desired parameter.
- Step 2: Enter the desired address using the keypad.



CAUTION: *Be careful not to duplicate any address in the DMX order of parameters in the new fixture. Ion does not prevent you from duplicating addresses.*

To define the LDMX address of any 16-bit channel:

LDMX or “low-DMX” is the DMX address for the second half of any 16-bit channel. If used in Coarse/Fine determination. The DMX channel defines the “Coarse” adjustment and the LDMX defines the “Fine” adjustment.

- Step 1: Use the **[Page]** keys to navigate to the “LDMX” column of the desired parameter.
- Step 2: Enter the desired address using the keypad.

To alter the Home settings for any parameter:

You can define the value for any parameter’s “home” value.

- Step 1: Use the **[Page]** keys to navigate to the “Home” column of the desired parameter.
- Step 2: Enter the desired home value (0-255 for 8-bit, and 0-65535 for 16-bit) using the keypad.

To enable the Snap setting for parameters:

You can enable snap for parameters to exempt them from cue timing, so they snap to their new value. For more information about snap, see [Snap Parameters, page 93](#).

- Step 1: Use the **[Page]** keys to navigate to the “Snap” column of the desired parameter.
- Step 2: Press **{Snap}** or click in the “Snap” column for the selected parameter to enable.

Range editing a parameter

You can enter the operational ranges for specific slots within any specific parameter (such as color scroller, color wheel, gobo wheel, and so on).

For example, if the parameter were “Gobo Wheel”, and the fixture included a four-slot gobo wheel, you can use ranges to determine the minimum/maximum values for each of those slots. You can also label the slots and define the minimum/maximum values that will appear in the channel display for that parameter.

To define the range values for any parameter:

- Step 1: Use the **[Page]** keys to navigate to the parameter that you want to add ranges to.
- Step 2: Press **{Ranges}**. The range list will open.
- Step 3: Determine the total number of slots required by the parameter. *Be sure to include “open” slots when needed.*
- Step 4: Press **{New}** to add ranges. Repeat this step until you have as many slots as are required by the number determined in step 3.
- Step 5: Use the **[Page]** keys to select the range and field you wish to edit. Fields are:
 - **Min** - enter the minimum value (0-255) for the range slot you are defining.
 - **Max** - enter the maximum value (0-255) for the range slot.
 - **User Min** - enter the value that will be displayed to users (for example, what will be displayed in the live summary view) when the slot is at its minimum value. Value can range from -9999 to 65535.
 - **User Max** - enter the value that will be displayed to users when the slot is at its maximum value. Value can range from -9999 to 65535.
- Step 6: Press **{Label}** to add a label to any range slots. These will appear in the encoder LCD when the related parameter is displayed for the new fixture.
- Step 7: Press **{Done}** when you have finished editing the ranges.

Lamp Controls

For many devices, their lamp and motor control functions can be controlled remotely using DMX. These will often require use of a timed sequence of DMX levels to control various functions such as striking the lamp, resetting the fixture, and other specific actions.

To define the lamp controls for a device:

- Step 1: With the fixture selected, press **{Lamp Ctrls}**. The lamp control display will open.
- Step 2: Press **{New}** to add a lamp control.
- Step 3: Press **[Label]** or **{Ctrl Label}** to label the new lamp control.
- Step 4: Press **{Steps}** to open the lamp control editor.
- Step 5: Press **{New}** to add any additional steps needed for the lamp control.
- Step 6: Select the time column or press **{Time}** to change the timing for each step. Timing is in seconds. The standard time in the Eos Family library is 12 seconds.



Note:

*It is not recommended that you set the time to **{Hold}** unless the DMX value should permanently remain at that level. In order to alter a level set with a time of **{Hold}**, another lamp control to change that DMX value would need to be created.*

- Step 7: For each step created, press **{Levels}** to set the DMX addresses and levels. You may setup as many levels as needed for each step. Softkeys available for the fields are:
 - **{DMX Number}** - sets the DMX address.
 - **{DMX Level}** - sets the DMX level (0-255).
 - **{All Offsets}** - sets all parameters of the device to the defined level.

Copying a Fixture

It is possible to copy an existing fixture and then edit its parameters. In the fixture editor, there is a **{Copy}** button. Pressing **{Copy}** when a library fixture is selected will create a copy of that fixture and will assign it a new name. This new fixture can then be edited.

Merging Custom Fixtures into a New Show File

Custom fixtures are saved with your show file and not in the fixture library. If you want to use custom fixtures in a different show file, you will need to use the advanced merge function while in the new show file.

For more information, see [Partial Patch Merging, page 55](#)

Importing a Custom Fixture

You can import custom fixtures from an ASCII show file, see [Importing Show Files, page 57](#).

Update Library

When a new library is installed on Ion either from a software update or a separate fixture library file from the ETC website, changes in library data will not automatically update your show files. This is to prevent library changes from affecting a functional show file.

Using the **{Fixtures}** softkey in patch will open up the list of fixtures used in the current show file. In this view, you will be able to tell which fixtures in the currently loaded show file differ from the desk's fixture library. For fixtures that have a library update, the **{Update Lib}** softkey will display in white, and for fixtures that don't have an update, the **{Update Lib}** softkey will be grayed out.

Snap Parameters

Certain parameters may not want to be subjected to cue timing. Those parameters can be set to snap. By default, Ion will snap the parameters listed in the following table:

Beam FX Index/Speed	Effect Library	MSpeed	Shutter
Camera IR Image	Enable	Negative	Shutter Strobe
Clip Directory	File	Object Directory	Strobe Mechanism
Color Effect	File Type	Object File	Sync Source
Color Index	Front/Rear Projection	Output Command	Text
Color Mix	Generator	Page	Texture
Control	Generic Control	Position Blink	Timeline
Copy Mod	Image Movement Speed	Projector Input	Timeline Position
Cue	Internal Media Frame	Relay	Tracking Object
Dimmer Curve	Library	Select	Transition Speed
Edge Blend Profile	Macro	Shape	Transition Time
Effect File	Mode	Shape Library	Transition Type

In the **[About]** channel patch screen, the snap column shows which parameters for that channel are currently set to snap.

Channel 61
ETC Revolution RWM/RWM

Address Range: 1-23 Proportion: 100 Curve: None
Preheat: None Swap: OFF Invert Pan: OFF Invert Tilt: OFF
Keywords:
Notes:

Parameter	Address	Home	Park	Snap	DMX
Internal Media Frame	6	0		Enabled	0
Edge	7	0			0
Zoom	8	0			0
Position MSpeed	9	0		Enabled	0
Scroller MSpeed	10	0		Enabled	0
Gobo Wheel Select MSpeed	11	0		Enabled	0

Buttons on the right: Current Values, Background, Moves, Usage, Patch, Lamp Controls

If you wish to disable any of the default snap parameters or enable snap for parameters that are not by default enabled, you will need to first create a copy of the fixture profile. In the fixture editor for the copied profile, change the parameter settings via the Snap Enable/Disable column.

Note:

You will need to patch your fixtures to their new fixture type if you change which parameters are to snap or not.

www.carlosmendoza.com.mx

Chapter 5

Setup

This chapter describes the processes involved in changing your system settings to meet your preferences.

This chapter contains the following sections:

- **Opening Setup**96
- **Show**96
- **Desk**103

Opening Setup

To enter the setup screen, press **[Displays]>{Setup}** or go to the **Browser>Setup**.

The CIA will repaint to display the setup screen and the softkeys will change to display the various subcategories of setup. Ion defaults to display show settings, however if you have changed the view to another subcategory, Ion will remember the view you were in when you return to setup.

The setup subcategory softkeys are:

- Show
- Desk

Show

When you select the **{Show}** softkey, the CIA repaints to display the following screen:

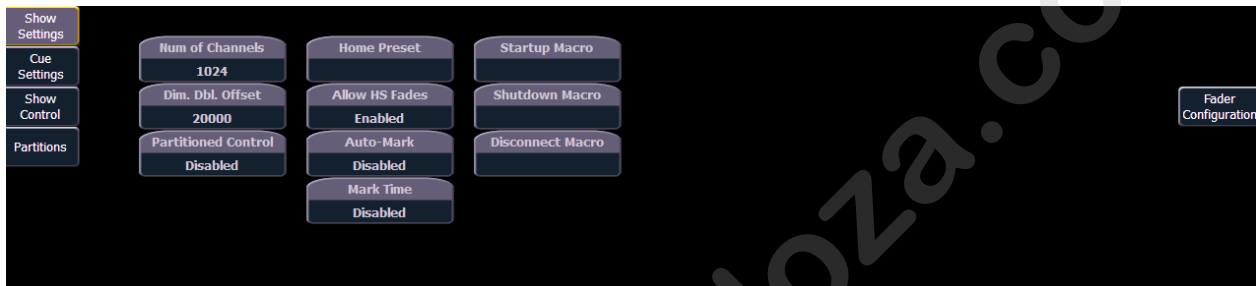

The buttons on the left are the setting categories within show setup. The show setup categories are:

- Show Settings
- Cue Settings
- Show Control
- Partitions

Show Settings

Click **{Show Settings}** to enter this category.

Nine fields will be available to you: **{Num of Channels}**, **{Dim. Dbl. Offset}**, **{Partitioned Control}**, **{Home Preset}**, **{Allow HS Fades}**, **{Auto-Mark}**, **{Startup Macro}**, and **{Disconnect Macro}**. To change the setting for any of these fields, click the field in the CIA to activate it. If the field requires data, enter it from the keypad. If the field is a toggle state, one click of the button will switch the field to its other state.

Changes from this screen are system wide and will impact all Ion consoles and clients connected to the system.

{Num of Channels}

You may use this field to set the number of channels in your Ion to the number of channels in your system. Ion supports a maximum of 99,999 channels. The default is 5,000. Only 10,000 channels can exist in the patch, but they can be distributed throughout the entire 99,999 channel count. Enter the number of channels for your system using the keypad. This entry must be confirmed with the **[Enter]** key.

Note:

Every part in a multipart channel will count as an additional channel for the channel count total.

{Dim. Dbl. Offset}

This allows you to set the address offset for dimmer doubling. The default for this is 20000, to match the Net2 standard offset, including Sensor dimming software. For dimmer doubling over Local DMX, this value should be set to 256.

{Partitioned Control}

Enables or disables the assigning of partitions. Default is “Disabled” (see [Using Partitioned Control, page 329](#) for more information).

{Home Preset}

Allows you to specify a preset that will be used as the home level for all non-intensity parameters stored in the preset, instead of the fixture library defaults. This preset will be applied for all “Go to Cue Out” and home commands. Intensity values in the preset will be ignored. Channels not included in the assigned home preset will continue to home to their library defaults.

{Allow HS Fades}

Hue and saturation (HS) color data normally fades in native space. Enabling **{Allow HS Fades}** will make HS data fade in HS space.

{Auto-Mark}

This toggles the AutoMark settings between enabled and disabled (see [Using Mark, page 191](#) for more information). AutoMark is disabled by default.

{Mark Time}

This field allows you to set the time that non-intensity mark instructions will use. When **{Mark Time}** is disabled, which is the default, mark instructions will use cue timing.

{Startup Macro}

This field allows you to set up a startup macro that will trigger after the console initialization has completed.

{Disconnect Macro}

This field can be use for disconnect macros or shutdown macros.

- Disconnect Macro - allows you to set up a disconnect macro that will trigger when the primary disconnects from its backup, or when a backup disconnects from the primary.
- Shutdown Macro - allows you to set up a disconnect macro that will trigger at power off, not when exiting the application.

Fader Configuration

This screen allows you to specify what your faders are assigned as: playbacks, submasters, or grandmasters. These faders can be used by opening the virtual faders (see [Fader Module, page 25](#)) or by using the Universal Fader Wings (see [Universal Fader Wings, page 389](#)).



Note:

Unless you need a grandmaster or a cue list loaded to more than one fader, it is generally not necessary to use the fader configuration screen. Assigning cue lists and submasters can all be done from live.

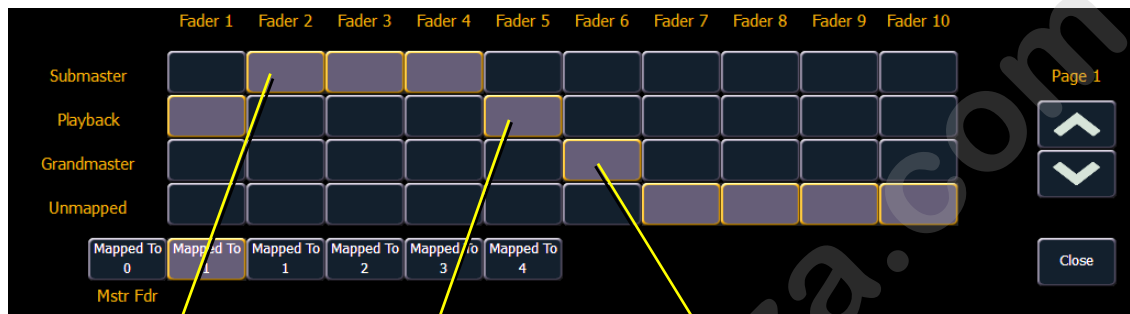

Defined as Submaster

Defined as Playback

Defined as Grandmaster

To change the configuration of any fader, use the **{Page}** buttons to access the fader page you wish to alter. For the desired fader, click the appropriate button (playback, submaster, or grandmaster) for the configuration you desire. Then click the **{Mapped to}** button and enter the number you want to map the fader to (see [Mapped to...](#) below). When you are done making changes, click **{Close}**.

To leave this screen at any time without saving changes, you *must* click **{Close}**.

Mapped to...

This button is used to specify the action target of any fader. It allows you to define the fader target that a slider is assigned to. Mapping is specific to the type of fader configuration (playback, submaster, or grandmaster).

Submaster - A maximum of 300 submasters can be recorded. **{Mapped to}** defines the submaster number that will be controlled by the specified slider. If a submaster slider is mapped to 10, when submaster 10 is recorded it will appear on that slider.

Grandmaster - 1 grandmaster may be assigned, but multiple instances of that GM may be mapped. A grandmaster inhibits all live intensity values. If the grandmaster is set at 50%, all live intensities will be at 50% of their actual values. Inhibited levels from the grandmaster do not impact data storage.

Playback - A maximum of 200 playbacks can be assigned. **{Mapped to}** allows you to have the same playback appear on multiple pages as it represents a playback number, not a specific fader or cue list number. To change the mapped location of any playback, click the **{Mapped to}** button for that slider and enter the number you wish to assign to it.

Unmapped - Selecting unmapped for any fader leaves that fader open and unoccupied.

Grandmasters, submasters, and playbacks may appear on more than one fader page.

In a partitioned control environment, the mapping of the faders (with the exception of the master fader) is global.



Note:

*Specifying a **{Mapped to}** location does not specify the cue list that will be loaded to that playback. Cue lists can be assigned to any playback. **{Mapped to}** establishes the order in which faders will be loaded.*

Master fader pair

It is possible to map the master fader pair as well. This will allow separate users to have different lists loaded to the master fader pair. The default mapping for the pair is 0.

Cue Settings

This screen allows you to set the default cue times for the parameter categories of your Ion system. To change a time, click the parameter category button in the CIA and enter the desired time on the keypad. To set a time for all categories at once, press **{Selection Button} [Thru]**. Pressing **[At]** selects manual times.

The categories for which you may set default times are:

- Intensity Up
- Intensity Down
- Color
- Focus
- Beam

Show Control

This section allows you to adjust settings for MIDI show control, time code (MIDI or SMPTE), analog, and serial functions. For more information on using show control with your system, see the Eos Family Show Control User Guide, which is available for download at www.etconnect.com.

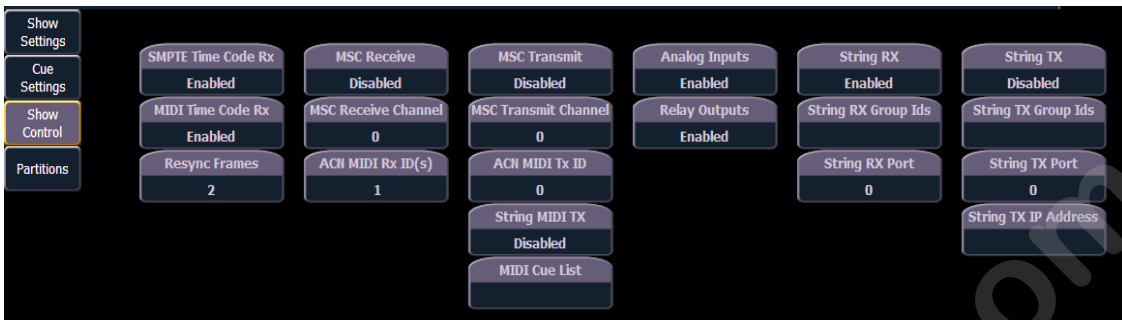

{SMPTE Time Code Rx}

This touchbutton is used to control whether your console can receive SMPTE time code. Choosing “Disabled” will disable all time code lists that have a SMPTE source. The default for this setting is “Enabled”.

{MIDI Time Code Rx}

As above, but for MIDI Time Code instead of SMPTE. The default for this setting is “Enabled”.

{Resync Frames}

This touchbutton allows you to configure how many frames need to be synced before timecode starts running. Frames can be from 1-30. Default is 2 frames.

{MSC Receive}

This touchbutton toggles the setting for receiving MIDI Show Control from an external source between “Enabled” and “Disabled”. The default setting is “Disabled”.

{MSC Receive Channel}

Also known as a “Device ID” this setting configures the MIDI channel for the console to receive MIDI Show Control information. Only MSC data with the same device ID will be received. A device ID can be from 0-126, or if set to 127, Eos Ti, Gio, Ion, or Element will receive MSC data from all IDs (All Call). Eos cannot be set as an All Call receiver. For example:

- **{MSC Receive Channel} [5] [0] [Enter]**

{ACN - MIDI Rx ID(s)}

This setting allows you to specify the MIDI Show Control data that your console will receive when transmitted over the Architecture for Control Network (ACN). When set, the console will respond to MSC data from any gateway that has its “ACN MIDI Rx ID” set to the same number. ACN MIDI Rx ID can be from 1-32. ID ranges may be used. When using the local MIDI ports on Eos Ti, Gio, Ion, or Element, this setting needs to match the MIDI Rx Group ID in the **ECU>{Settings}>{Local I/O}>Show Control Gateway>Group IDs**. For example:

- **{ACN MIDI Rx ID} [2] [5] [Enter]**
- **{ACN MIDI Rx ID} [1] [Thru] [1][0] [Enter]**

{MSC Transmit}

This setting, when enabled, allows the console to send MSC messages for actions taken on the console, such as cue actions, macros firing, and submaster bumps. The default setting is “Disabled”.

{MSC Transmit Channel}

Also known as “Device ID” this setting allows you to establish the device ID with which your console will transmit MIDI Show Control information. A device ID can be from 0-126, or if set to 127, Eos, Eos Ti, Gio, Ion, or Element will transmit MSC data to all IDs (All Call). For example:

- **{MSC Transmit Channel} [5] [0] [Enter]**

{ACN - MIDI Tx ID}

This setting allows you to specify the ID number of MIDI Show Control data that the console transmits over an Architecture for Control Network (ACN). When set, the console will transmit MSC data to any gateway that has its “ACN MIDI Tx ID” set to the same number. ACN MIDI Tx ID can be from 1-32. When using the local MIDI ports on Gio, Ion, or Element, this setting needs to match the MIDI Tx Group ID in the **ECU>{Settings}>{Local I/O}>Show Control Gateway>Group IDs**. For example:

- **{ACN MIDI Tx ID} [2][5] [Enter]**

{String MIDI TX}

When enabled, this setting will cause the console to send serial strings instead of a MIDI Show Control message when certain actions happen at the console.

{MIDI Cue List}

MIDI Cue List specifies the cue list that the console will use to send MSC data. If left blank and MSC Tx is enabled, all cue lists will generate MSC events. Otherwise, only the particular list (or lists) selected will fire MSC events.

{Analog Inputs}

This is a master setting for receiving analog inputs from a Net3 I/O Gateway or the local analog ports on a Gio, Ion, or Element. When disabled it will turn off all analog input for all event lists. Default is “Enabled”.

{Relay Outputs}

This is a master setting for triggering external relays from a Net3 I/O Gateway or the local ports on a Gio, Ion, or Element. When disabled it will turn off all external relays for all event lists. The default is “Enabled”.

{String RX}

This setting will enable receiving strings on all Serial RX formats.

{String RX Group IDs}

This button is for setting up which Serial Port Group ID (from I/O Gateway settings in GCE) the console will listen to. This only affects serial traffic from I/O gateways, not network UDP messages or ACN strings. Group IDs are from 1-32. Remember group IDs relate to the number set in the gateway. It can be set to listen to multiple group IDs by using **[Thru]** and **[+]**.

{String RX Port}

This setting specifies the UDP port that the console will listen to for receiving strings.

{String TX}

This settings will enable sending strings on all Serial TX formats.

{String TX Group IDs}

This button is for setting up which Serial Port Group ID (from I/O Gateway settings in GCE) the console will send to. This only affects serial traffic to I/O gateways, not network UDP messages or

ACN strings. Group IDs are from 1-32. Remember group IDs relate to the number set in the gateway. It can be set to send to multiple group IDs by using **[Thru]** and **[+]**.

{String TX Port}

Setting for the UDP destination port that the console will send strings.

{String TX IP Address}

Sets the destination IP address that the console will send strings.

Partitions

Pressing the **{Partitions}** button in Show setup opens the partition display in the CIA. This display shows any recorded partitions, including the four pre-existing partitions. For more information, see [Using Partitioned Control, page 329](#).

Desk

This setup softkey accesses settings for the user identified on the associated Ion device. Changing these settings does not impact other Ion controllers on the network assigned a different user ID.

{Record Defaults}

This screen enables you to change general record defaults.

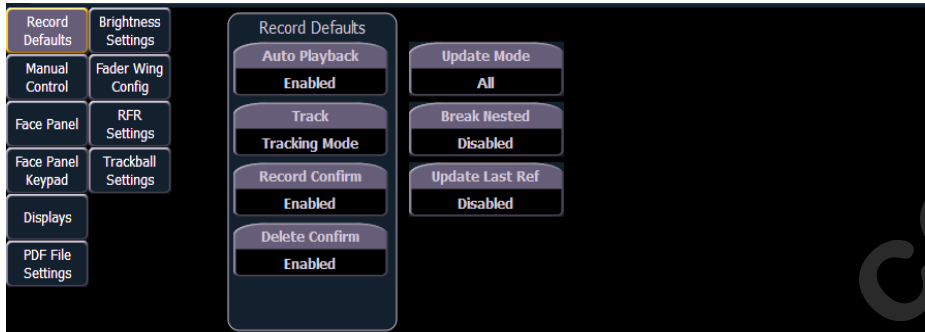

To change the setting for any of these fields, click the field in the CIA to activate it. If the field requires data, enter it from the keypad. If the field is a toggle state, one click of the button will switch the field to its other state.

Auto Playback

When enabled, this feature automatically plays back cues and submasters as they are stored and releases manual control. For submasters to automatically play back, the slider must be at full. This field is a toggle state between “Enabled” and “Disabled”. When auto playback is “Disabled”, all manual levels are maintained and cues must be loaded and executed on playbacks. The default is “Enabled”.

Track

This field allows you to switch between tracking and cue only modes (see [Tracking vs. Cue Only, page 5](#)). The default is “Tracking”.

Record Confirm

This setting allows you to enable or disable the confirm action when storing over a previously recorded target. The default is “Enabled”.

Delete Confirm

This field allows you to enable or disable a required confirmation before any delete command is executed. The default is “Enabled”.

Update Mode

This field allows you to select a default update mode (see [Update Styles, page 181](#)). The default is “All”.

Break Nested

This setting allows you to enable/disable the update modifier break nested. The default is “Disabled”.

Update Last Ref

This setting allows you to enable/disable the update modifier update last ref. The default is “Disabled”.

{Manual Control}

This desk setting button gives you access to Ion manual control settings.

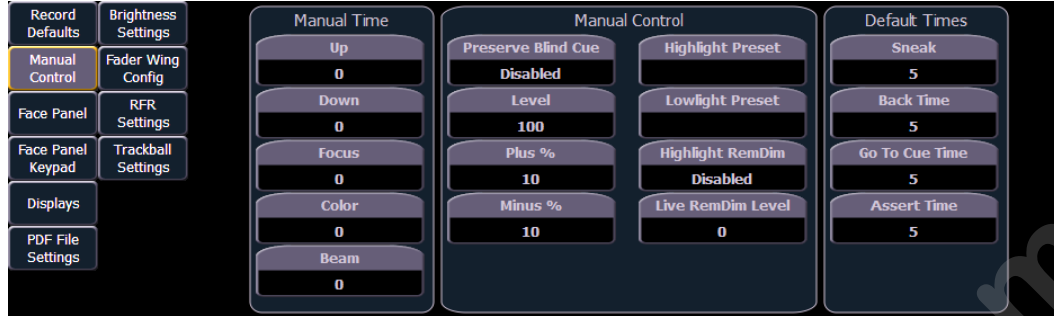

Manual Time

In this section you may change the default times for manual changes to occur in live. Times can be set for each parameter category (Intensity Up, Intensity Down, Focus, Color, and Beam). You may use the **[Thru]** key to enter a value for all categories.

- **{Int Up} [Thru] [9] [Enter]**

The default for each of these is 0 seconds.

Manual Control

This section allows you to specify the values for certain buttons and settings used in manual control. To change any value, click the appropriate button in the CIA and use the keypad to enter a new value.

Preserve Blind Cue - This enables the console to display the last selected cue in blind when you return to blind. The default is disabled.

Level - This sets the default for Level (which is accessed in Ion by double pressing **[Full]**). Any value between 0-100 may be entered. The default is 100.

Plus% - This sets the level for the +% (which is accessed in Ion by pressing **[Shift] & [+]**), which will increase the selected channel by the set percentage. Any value between 0-100 may be entered. The default is 10%.

Minus% - This sets the level for the -% (which is accessed in Ion by pressing **[Shift] & [-]**), which will decrease the selected channel by the set percentage. Any value between 0-100 may be entered. The default is 10%.

Highlight Preset - This field is used to specify the preset that will be used for highlight commands.

Lowlight Preset - This field is used to specify the preset that will be used for lowlight commands.

Highlight Rem Dim - This enables a Remainder Dim when any highlight or lowlight commands are given, thereby temporarily dimming any channel not participating in the High/Low. An intensity level or a preset can be assigned in this field. Channels not in highlight or lowlight that are not included in the RemDim IP or preset are not affected.

Live RemDim Level - This allows you to set the level for all remainder dim commands in live. The default is 0. An intensity level or a preset can be assigned in this field.

Default Times

In this section you may change the default times for sneak commands and the respective feature response times based upon parameter category. The default for these is 5 seconds, except for back time, which uses a default of 1 second.

{Face Panel}

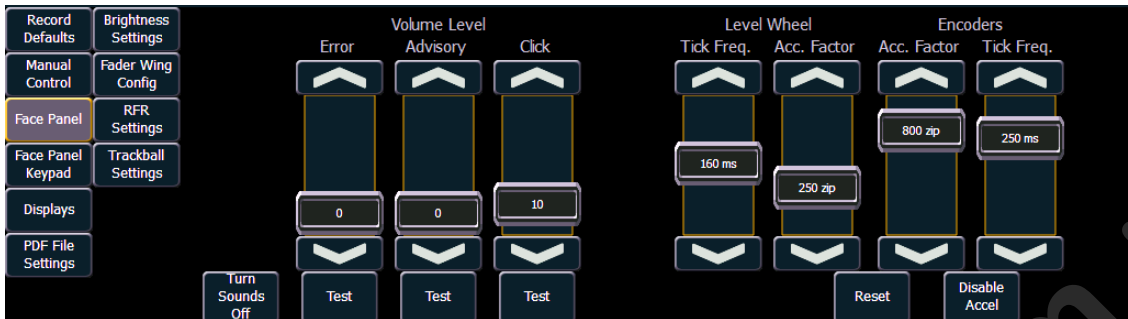

Sounds

You can adjust the frequency and length of the audible sounds that Ion delivers. Signals are qualified as being either an error, advisory, or click sound. All types of sounds can be adjusted from this setup screen in the CIA.

To adjust a sound, move the virtual slider with the mouse on the CIA. To hear the result of your adjustment, click the **{Test}** button respective to the sound type, located beneath the sliders.

To turn off all sounds completely, click the **{Turn Sounds Off}** button. The sound area will then be replaced with a **{Turn Sounds On}** button, which can be pressed to reactivate audible signals in Ion.

Level Wheel

You can adjust the increment and acceleration effect of the level wheel from this screen as well.

To alter the number of ticks in a full turn of the level wheel, adjust the slider labeled “LW ticks”. This will increase or decrease the amount of change effected when you use the level wheel. A higher tick setting will increase the amount of change resulting from one turn while lower settings will decrease the amount, making smaller adjustments easier to perform. The options range from 50 - 255 ticks. The default is 150.

Ion also provides an adjustable acceleration feature for the Level wheel. This feature allows you to adjust the wheel’s sensitivity to fast adjustments, thereby temporarily overriding the number of ticks setting. To adjust the level wheel acceleration, use the virtual slider labeled “LW Acc. Factor”. The higher the slider setting, the less sensitive the level wheel will be to acceleration. The lower the setting, the more sensitive it is. When set low, the faster you move the wheel, the greater the increment covered by a revolution. When movement stops, the normal LW ticks will be reinstated.

Encoder

Similar to “LW Acc. factor” (see above), the encoder acceleration factor is used to adjust the acceleration of all encoders.

To adjust the encoder acceleration, use the virtual slider labeled “Encoder Acc. Factor”. The higher the slider setting, the less sensitive the level wheel will be to acceleration. The lower the setting, the more sensitive it is.

“Encoder Tic Freq.” can be used to increase or decrease the number of ticks in a full turn of the encoder.

Press **{Disable Accel}** to disable encoder acceleration. With acceleration disabled, two new options will be available: **{Encoder Degrees Per Revolution}**, which is for the pan & tilt encoders, and **{Encoder Percent Per Revolution}**, which is for the other encoders. When a pan or tilt encoder is moved one revolution, the parameter will change by as many degrees as defined in

Setup. The default is 30. When any other encoder is moved one revolution, the parameter will change by the set percentage of its entire range. The default is 35.

The settings for **{Encoder Degrees Per Revolution}** and **{Encoder Percent Per Revolution}** are stored with the showfile. Starting a new file will reset the two settings. Whether or not acceleration is disabled or enabled is not stored with the showfile.



Note:

If you turn acceleration off and move the encoder quickly, and you see movement of the associated parameter slightly greater than indicated by your encoder settings, a firmware update may be required for your Ion's encoders. See ["Firmware Update" on page 349](#).

{Face Panel Keypad}

Auto Repeat

This setting allows you to adjust the auto repeat settings (delay and speed) for the facepanel keypad.

Blackout

You can disable the **[Blackout]** hardkey here. By default, blackout is "Enabled".

Grandmaster

You can disable the Grandmaster. By default the Grandmaster is "Enabled".

Spacebar [Go]

You can enable the spacebar on an external keyboard as the hotkey for **[Go]**. By default, it is "Disabled".

Hide Mouse

With hide mouse enabled, if the mouse is left idle for 10 seconds, the cursor will go away. Once the mouse is used again, the cursor will return. By default, this is "Disabled".

{Displays}

This desk setting button gives you access to the Ion display settings.



High Contrast Display

This button toggles the setting between “Enabled” and “Disabled”. When enabled, high-contrast brightens the magenta used to show tracked values.

The default setting for this is “Disabled”.

Show Reference Labels

This button toggles the setting between “Enabled” and “Disabled”. When enabled, referenced record targets (such as presets or palettes) with labels will have their labels displayed in the live/blind display rather than their target type and number. **[Shift] & [Label]** can be used to temporarily toggle between views.

The default setting for this is “Disabled”.

Group Chans By 5

You can turn off/on the grouping of channels in groups of 5 in the live summary view from this field.

The default for this setting is “Enabled.”

DirSel.Dbl Clk

When enabled, double clicking a direct select button will act as **[Recall From] [Record Target]** to place the entire contents of that preset, palette, or step-based effect on stage. The default for this setting is “Disabled”. 100 Channel Display

This setting can be used to display 100 channels at a time in the live summary view. The default for this setting is “Disabled.”

Cmd Line on PSD

This setting can be used to display an optional command line on the Playback Status Display. The default for this setting is “Disabled”.

PSD Time Countdown

When enabled, the cue category times will countdown in the PSD as a cue is fading. The default for this setting is “Disabled”.

User Id

You can Change the User ID for the console by selecting this button and entering a number from the keypad. For more information on User ID see [About User ID, page 328](#).

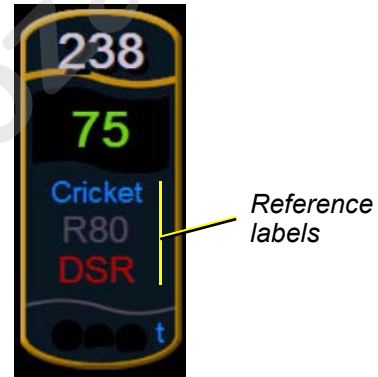

{PDF File Settings}

This screen allows you to select the orientation and paper type for PDF files.

{Brightness Settings}

This screen allows you to adjust the brightness and contrast settings for the Ion LCD, the fader wing LCDs, and desk lamps.

{Fader Wing Config}

This screen allows you to manually configure the positions of fader wings connected to the Ion. The console will default to configuring the wings on its own. To manually configure, you must click on the **{Manual Config. Off}** softkey.



Clicking on the **{Manual Config. Off}** button turns manual configuration on and displays the Fader Wing Configuration screen.



Clicking **{Identify}** will display numbers on each wing's display to aid in configuration. The numbers do not identify the wings as to their actual order. Order is determined from left to right. The left most wing will contain the first faders, unless a 1x20 wing is attached. A 1x20 will always contain the first faders regardless of other wings to the left of it.

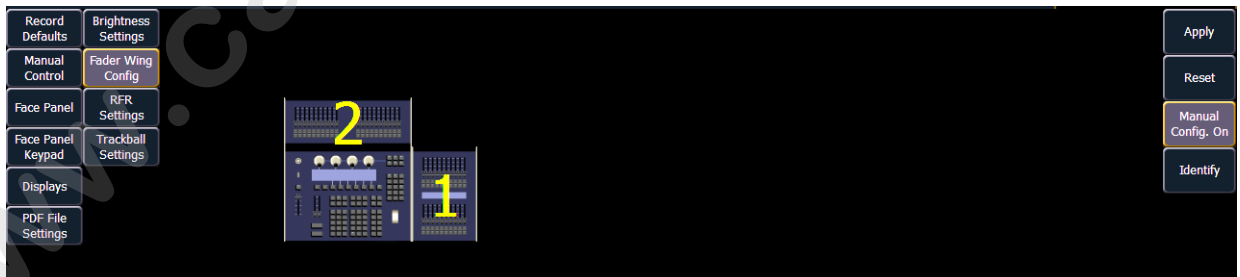

Click and drag the wings to match your physical layout. Click **{Apply}** to save the changes. Clicking **{Reset}** will restore to the last saved configuration. Clicking **{Manual Config. On}** will turn off manual configuration and will require a restart of the application before the console will automatically configure the wings. For more information on using fader wings, see [Universal Fader Wings, page 389](#).

{RFR Settings}

This screen is for allowing Net3 RFR, iRFR, and aRFR connections. The default setting is "Enabled". For more information see [RFR, page 352](#) and [Radio Focus Remote \(RFR\), page 378](#).

{Trackball Settings}

This screen allows you to select various trackball options and adjust settings.

Trackball Tick Freq.

This fader adjusts the trackball tick frequency. The default is 200 ticks.

Trackball Acc. Fctr

This fader adjusts the trackball acceleration factor. The default is 800 zip.

Swap Pan/Tilt

This touchbutton swaps the directions for Pan and Tilt on a trackball. The default for Pan and Tilt is X and Y, respectively. When this button is enabled, Pan and Tilt will be Y and X.

Reverse Pan

This touchbutton reverses the direction of Pan.

Reverse Tilt

This touchbutton reverses the direction of Tilt.

Reset

This button resets all five trackball settings back to their default.

www.carlosmendoza.com.mx

Chapter 6

Basic Manual Control

Ion provides a variety of ways to select and command control channels. This chapter identifies the many basic ways you can select channels and manipulate show data within Ion.

This chapter contains the following sections:

- **Selecting Channels** 112
- **Setting Intensity** 114
- **Manual Control of Non-intensity Parameters (NPs)** 115
- **Home** 123
- **Select Last** 123
- **Multiple Intensity Channels** 124
- **Lamp Controls** 125
- **Using +% and -%** 126
- **Remainder Dim** 127
- **Highlight and Lowlight** 128
- **Sneak** 130
- **Flip** 131
- **Channel Check** 131
- **Address at Level** 131
- **Address Check** 131
- **Flash** 132
- **Using {Move To}** 132

Selecting Channels

Ion provides interactive ways to select channels including the control keypad, faders, and direct selects. For information on using the direct selects for channel selection, see [Selecting Channels with Direct Selects, page 25](#).

Channels are deselected when any action is taken on the keypad that is unrelated to manual control, such as recording groups and cues, or updating a record target, etc. You can also press **[Clear]** after a terminated command line to clear the channel selection.

Select Channels From the Keypad

The keypad defaults to selecting channels. Channels may be selected on the control keypad using the **[+]**, **[-]**, and **[Thru]** keys for consecutive or non-consecutive channel selection.

The following examples illustrate various methods of selecting channels from the control keypad:

- **[5] [Enter]** - selects channel 5.
- **[5] [+] [7] [Enter]** - selects non-consecutive channels 5 and 7.
- **[5] [Thru] [9] [Enter]** - selects channels 5 through 9.
- **[2] [Thru] [8] [-] [5] [Enter]** - selects a range of channels 2 through 8, except channel 5.
- **[-] [6] [Enter]** - removes channel 6 from the current selection list.
- **[+] [1] [Enter]** - adds channel 1 to the current list of channels.



Note:

You may use **[+]** and/or **[-]** multiple times to add or remove multiple channels from the selection. **[Thru]** lists may be entered in ascending or descending order.



Note:

The **[Thru]** command uses the current flexichannel state. Channels not included in the flexichannel mode (except selected channels mode) are not collected in a thru range. **[Thru] [Thru]** can be used to collect all channels in the range, even if they are not in the current flexi mode. See "Using Flexichannel" on page 36.

Selecting Channels from Faders

Holding down the **[Fader Control]** button while a fader wing is attached will cause the last button on the wing to toggle between channel and fader modes.

In channel mode, each fader will control a separate channel for the number of faders available. Channels above the number of available faders will need to be controlled from the keypad.

Holding down **[Sneak]** while moving a channel fader will allow it to be moved without asserting control.

Using Groups as a Channel Collector

[Group] can be used as a quick way to collect channels from submasters, cues, palettes, or presets.

The following actions are possible:

- **[Group] [Cue] [1]** - selects all the channels in cue 1.
- **[Group] [Sub] [3]** - selects all the channels in submaster 3.
- **[Group] [Int Palette] [5]** - selects all the channels in intensity palette 5.

[Next] and [Last]

The **[Next]** and **[Last]** buttons increment and decrement channel selection. If only one channel is selected, **[Next]** increments the channel selection to the next sequential channel, while **[Last]** decrements the channel selection by one.

Select channel 10 then change the selection to channel 11 using the **[Next]** key:

- **[1] [0] [Enter]**

Channel 10 is selected with a gold outline around the entire channel and the channel number is indicated in white.

- **[Next]**

Channel 11 is now selected with a gold outline and white channel number while channel 10 is no longer selected.

If there is no specific channel selected when **[Next]** or **[Last]** is pressed, channel 1 is selected. When a group of channels is selected, pressing **[Next]** or **[Last]** selects the first or last channel in the channel list.

For Example:

Channels 11 through 20 are selected:

- **[Next]**

Channels 11 through 20 are still the specified channel list but only channel 11 is selected for control. You can now sequentially press **[Next]** or **[Last]** to cycle through the list. Press **[Select Last]** to reselect the entire range.



Note: **[Next]** and **[Last]** work with the current flexichannel state. See “Using Flexichannel” on page 36.

Offset

{Offset} is a feature used to select a range of channels from a broader channel selection. For the offset feature to function, you must first select a group of channels, then press **{Offset}**. When **{Offset}** is pressed, the softkeys change to the following: **{Even}**, **{Odd}**, **{Reverse}**, **{Random}**, and **{Reorder}**. These keys, along with the numeric keys from the keypad are used to create channel offsets. These channel commands can be combined with group record functions.

The following examples illustrate how offset works:

- **[1] [Thru] [10] {Offset} {Even} [Enter]** - selects channels 2, 4, 6, 8, 10.
- **[1] [Thru] [2] [0] {Offset} [3] [Enter]** - from the selected group, this syntax would select channels 1, 4, 7, 10, 13, 16, 19 which is an offset of every third channel from the selection.
- **{Group 5} {Offset} {Random} [Enter]** - selects all channels in Group 5 and places them in random order. This selection may be used only temporarily or it may be recorded to a new Group.
- **[1] [Thru] [2] [0] {Offset} {Even} {Random} [Enter]** - selects all even channels within the range and puts them in random order.
- **{Group 3} {Offset} {Reorder} [Enter]** - reorders the channels in group 3 so they are in numeric order.
- **{Offset} [4] [Enter]** -selects every fourth channel in the current channel selection.
- **[1] [Thru] [2] [4] {Offset} [4] [/] [4] [Enter]** - selects channels 4, 8, 12, 16, 20, and 24. You can select to offset by 2/2, 4/4, 3/3 etc.

Setting Intensity

Channel intensity may be manually entered from the keypad, set with an intensity palette (if programmed) or set with the level wheel. Pressing **[At]** after channel selection assumes an intensity value will be added to the selected channels. You may also use the **[Full]** button to bring the selected channels to their full intensity or you may use the **[Out]** button to fade the intensity out.

Use the Level (**[Full]** **[Full]**), +% (**[Shift]** & **[+]**) and -% (**[Shift]** & **[-]**) keys to affect the intensity value of selected channels. Each of these keys are set at a specific value established in the **Setup** (*{Manual Control}*, page 104).

- Level is set by default to full (100% intensity).
- +% and -% are each set by default value of 10 points.

The following examples illustrate the various methods of setting intensity:

- **[1] [+]** **[3] [At]** **[5] <0>** **[Enter]** - selects channels 1 and 3, and sets an intensity level of 50%.
- **[1] [Thru]** **[5] [-]** **[4] [Full]** **[Enter]** - selects a range of channels 1 through 5, except channel 4, and sets the intensity to full.
- **[1] [Thru]** **[8] [At]** **[+]** **[3] <0>** **[Enter]** - adds 30% to all intensities in the channel selection. If they were at 50, they will now be at 80. If channels 1, 3, and 5, were at 30 and 4 was at 50, they would be 60% and 80% intensity, respectively.
- **[5] [Thru]** **[8] [At]** **[-]** **[3] <0>** **[Enter]** - scales the intensities of the selected channels in the list down 30% of their current values.
- **[1] [Thru]** **[4] [At]** **[/]** **[1] [3] [0]** **[Enter]** - scales the intensities of the selected channels in the list up 30% of their current values. If channels 1 through 4 were at 40% intensity, this would scale them up by 30% to a value of 52.
- **[2] [+]** **[5]** [level wheel] - roll the wheel up for greater intensity or down for less intensity.
- **[1] [Full]** **[Full]** - selects channel 1 and sets it to full and self terminates the command line.
- **[Group]** **[9] [Out]** - selects all channels in Group 9 and sets the intensity values for those channels to zero. As long as channels are on the command line you can continue to address them with commands without having to reselect them.
- **1] [0] [At]** **[At]** - selects channel 10 and sets an intensity level as established in **Setup**.

For Example:

- **[1] [Thru]** **[5] [Full]** **[Enter]**

The selected channels are highlighted in gold, with white channel text and red intensity values (indicating manual data). You may continue to modify channels 1 through 5 since they are still selected and displayed on the command line.

- **[Shift]** & **[-]** **[Shift]** & **[-]**

This command would reduce the intensity of channels 1 through 5 by 20%.

- **[At]** **[7] [5]** **[Enter]**

You can continue manipulating the selected channels so long as the channels are selected and displayed on the command line.

Level Wheel

You may set intensity for selected channels or addresses using the level wheel. Rolling the level wheel upwards increases intensity. Rolling it downwards (towards you) decreases it.

Manual Control of Non-intensity Parameters (NPs)

Non-intensity parameters can be set with a variety of controls including the control keypad, buttons on the central information area (CIA) and the encoders.

Parameter Display

The parameter display in the CIA is populated with only those parameters that are found in the patched devices. As channels are selected, the parameter display will change to show only parameters relevant to the selected channels.

The parameters are divided into the following categories: Intensity, Focus, Color and Beam. Each parameter category is represented with buttons in the parameter tiles. These buttons allow you to select the entire collection of all parameters within that category. You can also select a single parameter from a category using that parameter's button in the parameter display.

Beam has three subcategories which correspond to the way the encoders are mapped. They are **{Shutter}**, **{Image}**, and **{Form}**. These subcategories are represented with buttons in the CIA. Pressing these buttons allows you to select all parameters within those subcategories.



Within the CIA, in the upper left corner, notice the **{All NPs}** button. When pressed, this collects all non-intensity parameters for further editing.

Some examples of using parameter buttons are:

- **[1] {Iris} [5] [Enter]** - Places the iris parameter of channel 1 at 50%.
- **[Group] [4] {Zoom} {Edge} [Out] [Enter]** - Sends any zoom and edge values for all fixtures in group 4 to 0%.
- **[1] [Thru] [3] {All Speed} [At] [2][5][Enter]** - Sets all the available speed parameters for channels 1 through 3 to 25.

Setting Parameters with the Keypad

When the CIA is placed in parameter mode, all parameters of selected channels may be given numeric values through the keypad.

When no channels are selected, the CIA shows all of the parameters that are available in the lighting system. When channels are selected, the CIA condenses to show only the parameters that are appropriate to the selection set. If channels are selected that have different device types, such as spot and wash lights, the CIA will show all of the available parameters. Parameters that are not available to all channels are grayed out.

Using **[At] [/] [/]** will place the direct DMX value on the command line. For example, **[1] [At] [/] [/] [2][3][9] [Enter]** would put channel 1 at DMX value 239.

The following examples illustrate how to set parameter values with the keypad:

- **[5] {Iris} [5] {Zoom} [6] [5] {Edge} [5] [Enter]** - sets channel 5 to an iris value of 50%, a zoom value of 65%, and an edge value of 50%.



Note:

*Pressing **[Shift] + [Encoder Paging Key]** will place the associated parameter onto the command line for numeric entry.*

Adjusting Parameters Using + and -

[+] and **[-]** can be used to adjust parameters from the command line. When using **[-]**, you will need to preface the command with **[+]** if you want to remove from the current value.

For Example:

- **[Channel List] {Pan} [1][0]** - sets to 10 degrees.
- **[Channel List] {Pan} [+][1][0]** - adds 10 degrees.
- **[Channel List] {Pan} [-][1][0]** - sets to -10 degrees.
- **[Channel List] {Pan} [+][-][1][0]** - removes 10 degrees.

Setting Non-intensity Parameters with the Encoders

Encoders provide a quick method to adjust current values for non-intensity parameters. The four encoders are pageable using the six encoder page hardkeys to the upper right of the encoder LCD.

The encoder page keys consist of: **[Focus]**, **[Custom]**, **[Color]**, **[Form]**, **[Image]**, and **[Shutter]**. Form, Image and Shutter are subcategories within the broader parameter category of Beam.

- **Focus** - includes pan and tilt control.
- **Custom** - includes intensity and intensity MSpeed.
- **Color** - includes all color mixing controls (CMY, RGB, HS), as well as scrollers, color wheels and color effects.
- **Form** - includes parameters that affect the quality or size of the light output, such as edge, zoom, iris, IMF, frost, etc.
- **Image** - includes anything that drops into the gate, such as gobos, effects wheels, etc.
- **Shutter** - includes all of the framing devices for the luminaire.

The LCD beneath the encoders indicates the parameters they control and provides additional information about the current status of those parameters. Encoder pages populate with parameters relevant to fixtures in the show patch. When you access a parameter page, controls that are not available for selected channels are suppressed.



Note: Pressing **[Shift]** & **[Encoder Page Key]** will post that parameter to the command line. For example, pressing **[Shift]** & **[Color]** would place **Color** on the command line.

Encoder LCD screen

The encoder LCD displays the active parameter category loaded on the encoders, as selected by the page buttons. Each encoder has an associated control section in the LCD that provides visual indication of:

- The parameter it controls.
- The current setting (value) of the parameter.

For Example:

Encoder wheel 1	Encoder wheel 2	Encoder wheel 3	Encoder wheel 4
Pan	Tilt	Position MSpeed	
LIVE: Cue 1 Chan 72__			
L8		User 1 Primary Master	
1	Home	Flip	TrckblOn/Off

The above graphic shows the encoder LCD displaying the focus parameters for a moving light.

- Encoder 1 is controlling pan.
- Encoder 2 is controlling tilt.
- Encoder 3 is controlling position MSpeed.
- Encoder 4 is not assigned.

Pressing a different encoder page key loads the encoders with other parameters of that type (if available).

Encoder paging

The number of pages for each category is displayed at the right of the LCD. You can go directly to the page required by pressing the encoder page button and a page number. For example:

- **{Form} & [3]** - this will take you to the third page of the form category.

Information in the encoder LCD is only as accurate as the patch information for that channel. For example, when you are working with color scrollers, the standard manufacturer color frames will be displayed for scroller controls unless you have created a custom scroll for the selected channel in patch using the Scroll Editor.

When you have created a new scroll or wheel in patch for any channel and that channel is selected, the custom information is displayed in the associated encoder LCD. See [“Creating a new scroll or wheel” on page 78](#).

The encoder pages change depending on the channels selected. Below are scenarios to explain some of the possible operating conditions:

- Parameters that are in the show patch but do not apply to the selected channels are suppressed. The parameter name will be displayed in grey, but controls will be withheld as they are not applicable to the selected channel.
- When a group of channels is selected with some parameters that are similar but others that are not, the following will occur:
 - Parameters that are shared by all selected channels are displayed in white, with control provided for all channels.
 - Parameters that are available to some, but not all, of the selected channels are displayed in grey, with all available controls indicated. You may use these controls but the channels that do not support the relative parameters will not respond to the actions.
 - Parameters that none of the selected channels support are displayed grey, with only the parameter name shown.
- When you access a parameter page, the encoder wheels will automatically load and display the first page that has a valid parameter for the selected channels.

Encoder softkeys

If you press the encoder for any parameter, the softkeys change to display options relevant to that parameter. These may include **{Home}**, **{Last}** and **{Next}**, or **{Min}** and **{Max}**, and depending on the type of parameter, a **{Mode}** or **{Calibrate}** button.

Home

Each parameter has an associated **{Home}** softkey. This accesses any parameter and returns it to its default position. Additionally, the control keypad has a **[Home]** key. The **[Home]** key on the control keypad is a channel level instruction, meaning the entire luminaire will return to its home position unless you modify the instruction by selecting specific parameters or parameter categories.

The following examples illustrate use of these two keys, both from the control keypad and the softkeys:

- **{Home}** - when pressed from the encoder LCD, only the associated parameter of the selected channels will return to its home position.
- **[1] {Home} [Enter]** - homes all non-intensity parameters of channel 1. When this command overrides playback data, it results in a manual value for the associated parameters. When this command is an override of only manual data, it returns the parameters to their home position and removes the manual setting.
- **[1] {Color} [Home] [Enter]** - homes all of the color data for channel 1. You may also use the **{Color}** encoder page button for this command.

Min and Max

{Min} and **{Max}** are displayed when the parameter is linear, such as a shutter. Use these keys to set a minimum and a maximum setting for a parameter.

Next and Last

{Next} and **{Last}** are displayed when the parameter is segmented such as a fixed gobo or color wheel or a color scroller. Use these keys to increment or decrement in full frames.

Mode

The **{Mode}** key is provided to select different modes for the encoder wheel such as rotate, index, or special effects.

- When more than two modes are available, the **{Mode}** key can be pressed repeatedly, advancing through the various modes. Each mode will display beneath the current parameter setting.
- When only two modes are available, the alternate mode is indicated instead of a **{Mode}** key. Toggling that button switches the encoder wheel to the alternate mode.

Flip

The **{Flip}** button, available in the Pan/Tilt section of the encoder LCD, is used to flip the unit into its exact same position, but from the other direction. Depending on the current values of pan and tilt, there may be multiple flips.

Trackball On/Off

The **{Trackball On/Off}**, as displayed in the Pan/Tilt section of the encoder LCD when either the pan or tilt encoder is held down, is used to give pan and tilt functionality to a mouse or trackball device. When this function is turned on, above the CIA will be a message saying “Cursor as Pan/Tilt”.

Multiple Encoder Control

When parameters require more than one encoder for full control, the encoder LCD provides indication that the encoders are related to each other by name. Typically, additional modes will load on other pages but will reference the master parameter unique name. If there are multiple instances of a device in a single channel (such as two fixed gobo wheels or two color wheels, etc.), each device will load onto separate encoders.

Form Control

Form (a subcategory of Beam) collects the parameters that affect the quality of the beam, including the iris, edge, frost, etc. ‘Shutter’ and ‘Image’ are the other two subcategories of Beam.

When the **[Form]** encoder page button is selected, the LED will illuminate and the encoders automatically populate with the “Form” parameters as specified in the show patch. If there are more parameters in the show patch than will fit on the first page of the encoders, press the **[Form]** button again to page through the remaining parameters in the category or press **[Form]** and a page number to jump to a specific page.

The form parameters may include:

- **Edge** - controls the hard and soft qualities of a spot luminaire. While some fixtures may call this parameter “focus”, it is always represented as “edge” in Ion, to avoid confusion with “Focus” which refers to pan and tilt data. These values are set to the system default value for the selected luminaire, but may be modified as required on a per fixture basis.
- **Iris, Zoom, Strobe and IMF**- each parameter has in/out, narrow/wide, or fast/slow settings. Iris and Zoom also have programmable limits, called in/out and narrow/wide respectively. The strobe mode setting varies based on the fixture type.

Image Control

Image is the collection of parameters that affect the contents of the beam (gobo, prism, effects wheel, etc.).

Shutter Control

Pressing the **[Shutter]** button displays shutter controls, if there are any fixtures with framing devices patched.

Press the **[Shutter]** button again to access the additional shutter controls, available to the specific channel.

Color Control

Depending upon the specific device, color can be established manually with the encoders using:

- CMY color-mixing
- Hue and saturation color mixing
- RGB color-mixing
- Selection from a color wheel or scroller

You may also specify color by using the hue and saturation (HS) color picker and gel picker.

It is also possible to set non-intensity parameter data with direct entry using the control keypad and using the parameters on the CIA.

- **[1] [At] [4] <0> {Cyan} [5] [5] [Enter]**

The first page of the color encoder will provide some scroller control, such as frame selection, on the top encoder. The next three encoders will control HS, CYM, or RGB color mixing. There will be buttons on the first page for switching between HS, CYM, and RGB. The HS controls will include buttons for **{Brightness to Full}**, **{Home}**, **{Min}**, and **{Max}**. The CMY and RGB controls include buttons for **{Home}** and **{Max}** for each of the parameters. No **{Min}** button will be displayed.



Note:

Color scroller data will display on the encoders and displays as frame numbers, F1, which would be frame 1, F2 for frame 2, etc. F1.5 is halfway between 1 and 2. F2+ will display if the frame is less than 2.5 and F2- if the frame is greater than 1.5. After the frame number, the gel number will also be displayed.

*Frame numbers can be used from the command line. **[2]{Scroller}[5][Enter]** will send channel 2's scroller to frame 5. Frames can also be selected by using the DMX value for that frame. Pressing **[/]** twice will post DMX to the command line. **[3] {Scroller} [/][/][2][5][5] [Enter]** will send channel 3's scroller to the frame with the DMX value of 255.*



Note:

Dual scroller fixtures are addressed as 0-100% instead of by frame numbers. You may need to update your fixture before this feature will work. See ["Update Library" on page 88](#).

Custom Control

Pressing the **[Custom]** button displays intensity controls.

Using the Color Picker

Press the **[Displays]** button and select the **{Color Picker}** from the softkeys to display the color picker in the CIA.



Within the color picker, you will see columns of buttons to the right. The first button **{Color Format}** is for toggling between native (RGB, CMY, color scroller, or color select) and hue and saturation. The other buttons are manufacturer catalogs of gels. To display a specific manufacturer's catalog, press the specific manufacturer or catalog and select the desired gel. The **{Bright. to Full}** button will only appear if selected channels have a brightness parameter.

When channels are selected and a specific gel is chosen, the color picker will show a dot which represents the selected fixture(s). The dot is a visual indication of the color each fixture can accommodate, closest to the gel selected. This tool is most useful when color matching between different fixture types to maintain an even field of color. You can click in the picker to go to the hue and saturation values or you can match a specific gel color from the manufacturers' list on the right. Selecting a specific gel will also produce the hue and saturation value.



Note:

When using the color and gel pickers for 'non-standard' LED fixtures, such as those that use RGBA, RGBW, and RGBAW, the Amber output will live halfway between red and green. White output will not be driven by hue/saturation directly.

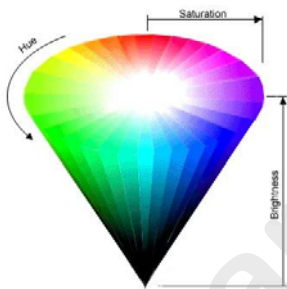

What is Hue and Saturation?

Hue is the actual color. It is measured in angular degrees around the cone starting and ending at red = 0 or 360 (so yellow = 60, green = 120, etc.).

Saturation is the purity of the color, measured in percent from the center of the cone (0) to the surface (100). At 0% saturation, hue is meaningless.

Brightness is measured in percent from black (0) to white (100). At 0% brightness, both hue and saturation are meaningless.

Gel colors can also be manually entered into the command line. **[6] [Color] [1] [/] [1050] [Enter]** assigns Apollo gel number 1050 to channel 6. Each of the manufacturers have been assigned a number, which can be seen beside their name in the Color Picker display.

When channels are selected, a black line may appear in the color picker. This line indicates what colors can be mixed by the fixture. If a color lies outside of the line, that color is out of the range of that device. If no black line is visible, the fixture has not yet been calibrated and the color matching will be approximated.

The gel picker is normalized to 3200 degrees. Therefore, if you are setting Rosco 80 (R80) on a arc source device, it will appear to be the same color as R80 on an incandescent source.

Encoders

When both CMY and RGB mixing systems are present in the lighting system, they take priority in the encoder mapping, followed by fixed wheels, then scrollers. A CMY color mixing fixture may not be placed in RGB mode, nor can an RGB fixture be placed in CMY mode.

- When the device is a fixed color wheel or a color scroller, you can use the encoder to select the desired frame. Pressing the **{E}** expands the display to include a button for each frame indicated with both a location number (example: “#5”) and a label (example: “Rosco R80”). The specific colors within the scroller or wheel are specified in patch. [See “Creating a new scroll or wheel” on page 78.](#)

Home

Ion is equipped with a **[Home]** hardkey. This hardkey allows you to home a specific parameter. Additionally, you may home all of a channel's non-intensity parameters or home only a specific category (I, F, C, B).

Homing a channel, category, parameter, or submasters will return it to the default value.

- **[1] [Home] [Enter]** - homes all parameters for channel 1, except intensity.
- **[1] [Color] [Home] [Enter]** - homes all color parameters for channel 1.
- **[Group] [1] [Color] [Focus] [Home] [Enter]** - homes the color and focus parameters of all channels in group 1. You can use the category keys in the CIA or the encoder paging keys.
- **[Sub] [1] [Home] [Enter]** - homes submaster 1.
- **[Sub] [1] [Thru] [Home] [Enter]** - homes all submasters.

You can select a preset to provide home values for non-intensity parameters (instead of fixture library default values) when home commands are used. Store a preset with modified home values for only the channel parameters you would like at a different value than default. And then assign that preset to Home in Setup (see [Show Settings, page 96](#)). Since home does not impact intensity, any intensity values stored in the home preset will be disregarded. Any channels that are not included in the preset assigned to Home in Setup will use their library defaults.

Select Last

The **[Select Last]** key allows you to reselect the previous channel selection. This includes multiple channel selections, groups, and so on. Using **[Select Last] [Select Last]** you can recall the last completed command line. However **[Select Last] [Select Last]** will not terminate the command line, **[Enter]** is required.

Pressing **[Shift] & [Select Last]**, the softkeys on Ion change to display the following additional options:

- **{Select Active}** - selects all active channels. Pressing **{Select Active}** once will capture all active levels. Pressing **{Select Active}** twice will capture all active manual levels and those from playbacks except for submasters. Select NonSub Active will post to the command line.
- **{Select Manual}** - selects all channels with manual data.
- **{Select All}** - selects all channels.

On a completed command line, using **[At]** or **[Select Last]** after **{Select Active}** or **{Select Manual}** will post the numeric channel list to the command line.

For example, cue 1 is active, and has channels 1 through 5 at full. Using the syntax, **{Select Active} [Enter] [At]** will post channels 1 through 5 onto the command line.

Another example, Channels 10 through 20 have a manual level of 75. Using **{Select Manual} [Enter] [Select Last]** will put channels 10 through 20 onto the command line.

Multiple Intensity Channels

When a fixture with multiple intensity parameters is patched, Ion assigns it a master intensity. The master intensity can be used to control the multiple intensities together. The master intensity is handled in the same way as the intensity of a single intensity channel. Levels can be set via the level wheel, from the keypad, and the encoders. Master intensity can also be set via the parameter buttons in the CIA. **{Intens}** controls the master intensity. The other intensities will default to 100%.

Control of the individual intensities of a multiple intensity channel is handled using keypad with the parameter buttons in the CIA (see [Manual Control of Non-intensity Parameters \(NPs\), page 115](#)) or the encoders. Pressing the **[Custom]** button will map the intensity parameters to the encoders. You can either use the encoder itself to adjust the level or you can press down the encoder of the parameter you wish to put on the command line.

Intens 100.000 %	Intens 1 100.000 %	Intens 2 100.000 %	Intens 3 100.000 %
LIVE: Cue 1 Chan 100 ◆			Intensity Page 1 of 2
L8		User 1	Primary Master
1	Effect Status	Color Picker	Patch Setup Curves Browser

Levels assigned to the individual intensities will act independent of each other and the master intensity.

- **[1][0][0] {Intens 3} [At] [5][0]** - sets intensity 3 of channel 100 to 50% intensity.
- **[1][0][0] [At] [7][5]** - sets the master intensity of channel 100 to 75% intensity. All intensities for channel 100 will be mastered to 75% unless they have a separate intensity set.

In Table view, Ion will default to showing all intensity parameters associated with the channels.

Ch	Intens	Intens 1	Intens 2	Intens 3	Intens 4	Hue	Saturatn
125	84	30	100	50	100	0	0

In summary view, the master intensity is shown. If one of the multiple intensities has a value, an '+' will display beside the master intensity.



indicates that there is a level set from an individual intensity

Lamp Controls

Lamp controls allow you to execute control functions of selected fixtures such as calibrate, douse lamp, strike lamp, and reset. Each fixture type has its own set of lamp control options which are available to you when you select the fixture from live and press the **{Lamp Cntrl}** softkey. This information is also available using **[About]** (see [Using About, page 267](#)).

For Example:

- **[1] [1] [Enter] {Lamp Cntrl}**
- or-
- **[1] [1] [Enter] [About] {Lamp Cntrl}**

This screen displays any lamp controls associated with the selected channel (this is also the “Lamp Control” subscreen of About). If the channel is a conventional (intensity-only) fixture, no parameters will be displayed. When the selected channel is an automated luminaire, options specific to the fixture type will display for use. Available RDM functions will also display here.

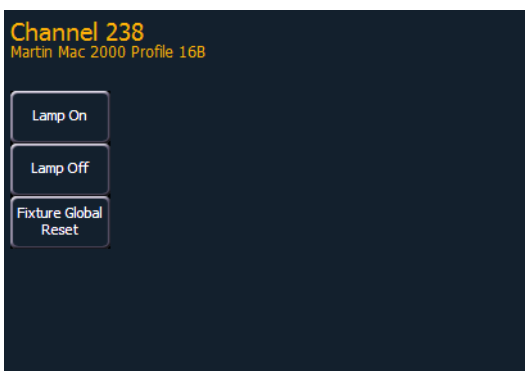

Pressing any of these parameter control buttons will affect the selected channel after a confirmation.

Exit the lamp controls display by pressing **[Displays]**.

Using +% and -%

Use +% and -% to incrementally change parameter values. To access this function on Ion, press **[Shift] & [+]** or **[Shift] & [-]**. By default, +% and -% are assigned a value of 10. This can be changed in **Setup**. This can be used with any parameter.

Channel Intensity

When channels are selected, pressing **[Shift] & [+]** increments the intensity level by 10 (or by the value established in setup, see [{Manual Control}, page 104](#)). Alternatively, you may press **[Shift] & [-]** to decrement the intensity level by 10. You may use these keys consecutively to “add to” or “subtract from” the intensity level.

For Example:

Select channels 1 through 10 and set them to an intensity level of 45% from the keypad.

- **[1] [Thru] [1] [0] [At] [4] [5] [Enter]**

Change the intensity level to 65% using +% which is set to its default value of 10% in the setup menu.

- **[Shift] & [+]** **[Shift] & [+]**

Non-intensity Parameters

+% and -% may be used to incrementally adjust non-intensity parameters as well.

For Example:

- **[1] {Iris} [Shift] & [+]** **[Shift] & [+]**
- **{Zoom} [Shift] & [-]** **[Shift] & [-]**

Remainder Dim



Note: *By default, [Rem Dim] will set to zero. In Setup, you can assign a remainder dim value of something other than zero. See “{Manual Control}” on page 104. For the purposes of this discussion, the default value of zero will be used in examples.*

[Rem Dim] temporarily provides a zero intensity to all channels except those that are currently selected, those that are parked, or those with intensity contributions from submasters. If the remainder dim command is reversed, the stage returns to its previous state. You may use the following commands for remainder dim:

- [Next] and [Last]- moves through the channel list.
- [select channels] [Rem Dim] [Enter] - sets all non-selected channels to zero
- [Rem Dim]- clears the rem dim function and returns the stage to its previous state

Pressing [Rem Dim] again releases all channels from rem dim mode and restores the stage to its previous state. Using the [Next] and [Last] buttons releases the current selected channel from Remainder Dim mode and sets its intensity to zero, while selecting the next or last channel and continuing Rem Dim operation.

For Example:

Assume channels 5 through 9 are selected and set at an intensity level of 50% and channels 10 through 15 are selected and set at an intensity level of 70%. Select channel 9 and dim the remaining channels.

- [9] [Rem Dim] [Enter]

Channel 9 is set at an intensity level of 50% and all remaining channels are dimmed to zero.

- [Next]

Selecting [Next] changes the channel selection to channel 10 which is set at an intensity level of 70%, the level set in the previous state, and all remaining channels including channel 9, are dimmed to zero.

[Rem Dim] can be used in groups including the use of [Next] and [Last] buttons to progress through the channels within the selected group.

For Example:

Assume you have group 1 selected (includes channels 1 through 10) with an intensity value of 50%, group 5 selected (includes channels 11 through 20) with an intensity value of 70%, and group 7 selected (includes channels 21 through 30) with an intensity value of 100%

- [Group] [1] [At] [5] [Enter]
- [Group] [5] [At] [7] [Enter]
- [Group] [7] [At] [Full] [Enter]

Select only Group 1 and dim the remaining Groups using the [Rem Dim] feature.

- [Group] [1] [Rem Dim] [Enter]

Channels 1 through 10 are selected with an intensity value of 50%, and all remaining channels are at a 0% intensity. You may progress channel by channel through the selected group (Group 1, channels 1 through 10) using the [Next] or [Last] key. Each press of the [Next] or [Last] key cycles you through only the channels of the selected group.

Pressing any other key terminates the [Rem Dim] mode and leaves channels at their remainder dim value.

You can set the dim level for all remainder dim commands in Setup (see [{Manual Control}, page 104](#)). When set to a value other than zero, all rem dim commands will bring intensity to this level instead. However it won't bring an intensity up. For example, if the rem dim level in setup is set to 50%, **[Rem Dim]** will drop any value above 50% to 50%, but not add intensity to any channels below 50%.

It is possible to override the dim level temporarily by specifying a level after the **[Rem Dim]** command.

[Rem Dim] can also be used to exclude channels from a submaster or cues during a **[Record]**.

For Example:

Using **[Rem Dim]** You can modify which channels are recorded in the submaster. For this example, assume that channels 1 through 10 are at full. You've recorded that to submaster one. Using **[Rem Dim]**, you can modify the record so only channels 1 through 5 are recorded to the submaster.

- **[1] [Thru] [1] [0] [At] [Full] [Enter]**
- **[Record] [Sub] [1] [Enter]**
- **[1] [Thru] [5] [Record] [Sub] [1] [Rem Dim] [Enter]**

A **[Rem Dim]** command can also be used on a selective cue record. It will force any channels not included in the record, but that are tracking forward from a previous cue, to zero.

Highlight and Lowlight

Ion can be placed in Highlight mode. Channels selected while in these modes will either go to a default setting, or to a value provided by a highlight preset (established in setup). Modifications can then be made to those channels. Any changes will be maintained when the highlight mode is removed.

To place Ion in highlight mode, press **{Highlight} [Enter]**. The command line will show that highlight is currently in use.

If no highlight preset is established, or for channels that have no value stored in the highlight preset, the following values will be applied to channels as they are selected:

- Intensity - full
- Focus parameters - no change from present state
- Color parameters - home value
- Shutter parameters - no change from present state
- Image parameters - home value
- Form parameters - no change from present state

For Example:

Step 1: **[Group] [1] [Highlight] [Enter]** - places channels 1 through 5 in highlight.

Step 2: **[Next]** - specifies channel 1.

- 1 is in the highlight value.
- 2 - 5 are in the lowlight value.
- All other channels go to the defined rem dim level.

You may assign both a highlight and a lowlight preset in setup (see [{Manual Control}, page 104](#)). Any preset may be used. Channels/parameters that are not included in the presets assigned to Highlight and Lowlight will continue to use their default highlight values (see above).

Lowlight Preset

The **{Lowlight Preset}**, which is set in **Setup> Desk> Manual Control> Lowlight Preset**, is used to define the behavior of specified but not selected channels while using **[Next]/[Last]** in highlight

mode. When in highlight mode, [channel list] or [Group] [n] [Enter] [Next] will select the channel list or group and isolate the first channel.

For example, {Highlight} [Enter] [6] [Thru] [1][5] [Enter] [Next] specifies channels 6 through 15 but channel 6 is the only channel selected. 6 is at the highlight level and 7 through 15 are at their lowlight levels. Pressing [Next] again will put channel 7 at the highlight level and 6 plus 8 through 15 at their lowlight levels. If there is no lowlight preset, these channels are not affected.

Temporary Highlight Level

The highlight preset can be overridden by setting a temporary highlight level. Using {Highlight} [At] [5][0] [Enter] overrides the highlight preset and sets the highlight level to 50. Non-intensity parameters are not affected and will use the default highlight setting or the highlight preset.

The temporary highlight level will remain until {Highlight} is pressed again or the channel is no longer selected.

Highlight/Lowlight Rem Dim

In addition to the highlight and lowlight presets, there is also a setting for {Highlight Rem Dim} in setup. See “{Manual Control}” on page 104.. When enabled and highlight mode is active, the intensity for all *non-selected* channels are automatically set to the Rem Dim value established in setup, if that Rem Dim value is lower than the channel’s current intensity. This can be used to help further isolate the channels you are working with in Highlight Mode

If you do not wish to enable Rem Dim globally in setup, you can specify a rem dim on the command line for temporary use. Rem Dim will use the {Live Rem Dim}, as specified in setup. See “{Manual Control}” on page 104.

- [High_Low] [Rem Dim] [Enter]

Sneak

The **[Sneak]** command (when a destination is not provided) removes manual changes from selected channels and allows the channels to *sneak* back to their background states (cue or submaster instruction, if any). For Expression users, this is similar to Release.

If there is no background state from the playbacks, the channel parameters will be set to their home position. The sneak command follows the sneak timing default established in Setup (see Setup - [{Manual Control}, page 104](#)), unless a timing value is provided as part of the sneak command.

The playback status display will show a red counter for sneak time. If multiple sneak times are being used, the most recently fired sneak time will be displayed. For an example of the sneak counter, see [Indicators in the Playback Status Display, page 37](#).

The sneak command can also be used to send a channel parameter to a specific destination, either with or without timing. The following examples illustrate the various methods of using the sneak command:

- **[channel list] [Sneak] [Enter]** - releases manual control, setting parameters to their background state. If there are current values for those parameters from a playback, those are the values that will be restored. If there are no values from a playback, the parameters are set to home (or default) position.
- **[channel list] [Color] [Sneak] [Enter]** - sneaks color of the selected channels to the default or background state.
- **[Sneak] [Enter]** - when no channels are selected, restores all channels with manual values to their background state.
- **[Sneak] [Sneak]** - puts **{AllINPs} [Sneak]** on the command line, which sneaks out all non-intensity parameters. **[Sneak] [Sneak]** is a self-terminating command.
- **[Sneak] <Time> [3] [Enter]** - restores all channels with manual values to their background state in 3 seconds.
- **[Group] [5] <Color Palette> [9] [Sneak] [Enter]** - selects group 5 and sneaks it to color palette 9 using default sneak time.
- **[Group] [3] [At] <Color Palette> [1] [Sneak] <Time> [7] [Enter]** - selects group 3 and sneaks it to color palette 1 in 7 seconds.
- **[Sub] [4] [At] [5] <0> [Sneak] [2] [Enter]** - selects submaster 4 and sneaks it to 50% in 2 seconds.



Note:

When recalling a reference from the direct selects to use with the sneak command, the sneak command has to be entered before the reference.

- **[Chan][1] [Sneak] {Preset 1}** - selects channel 1 and sneaks it to preset 1 using default sneak time.
- **[Chan][2][Sneak]<Time>[2]{Intensity Palette 3}** - selects channel 2 and sneaks it to intensity palette 3 in 2 seconds.
- **[Shift] & [Sneak]** - makes any manual data unmanual. The values will remain but they will no longer be available for **[Update]** or **[Record Only]** operations. When used with an empty command line, this will affect any and all manual data. When used with a channel selection, only those channels will be affected.

Flip

The **{Flip}** feature is used to invert the pan and tilt values of selected channels to achieve the same focus position from the opposite yoke position. This allows you to correctly focus a fixture that may be at the end of its pan or tilt range or to correct a fade that may be moving in an undesired direction. **{Flip}** is a softkey in the encoder LCD. To access it, press and hold either the “Pan” or “Tilt” encoder, then press the corresponding softkey.

The following example illustrates the use of **{Flip}**:

- [channel list] **{Flip}**

Channel Check

Channel check allows you to quickly step through all of your patched channels. This is useful for checking lamps or checking focus.



Note: *Parked dimmers will not be affected by the channel check feature.*

The following examples illustrates the how to use the channel check feature:

- **[1] [At] [7] <0> {Channel Check} [Enter]** - brings channel 1 to 70% intensity
- **[Next]** - channel 1 returns to its background state and channel 2 is set to 70% intensity.
- **[Next]** - channel 2 returns to its background state and channel 3 is set to 70% intensity.

Use **[Next]** or **[Last]** to progress through the channel list to complete the channel check. Any other key press other than **[Next]** or **[Last]** will terminate channel check mode. Channel check follows the current flexichannel state

Address at Level

The **{Address}** softkey in Live is used to send level information directly to an output address.

- **{Address} [5] [Full] [Enter]** - sets output address 5 to full. It will return to its previous level once the command line changes.
- **{Address} [2] [/] [1] [At] [/] [2][3][0] [Enter]** - sets universe 2, address 1 at DMX value 230.

With **{Address}** on the command line, you can use the level wheel to adjust the level.

After using the **{Address}** command, **[Next]** and **[Last]** may be used to increment the address number and set it to the same level. Addresses return to their previous level once the command line is cleared or **[Next]** or **[Last]** is used to increment to the next address.

This feature is useful when you want to perform an address or dimmer check.

Address Check

Address check allows you to quickly step through all of your patched addresses.



Note: *Address check differs from Address at Level because it skips non-intensity parameters of patched addresses. Since address check follows the current flexichannel state, it can be used with all channels to identify unpatched channels, or with flexi-patched to only show the intensity addresses of patched channels.*

{Address}[1] [At] [Full] {Check} [Enter] - brings address 1 to full intensity.

Use **[Next]** or **[Last]** to progress through the address list to complete the address check. Any key press other than **[Next]** or **[Last]** will terminate address check mode.

Flash

Using the **{Flash}** softkey in Live will bring a channel or address to full, and then every other second the level will move to 15%. That will hold for 1 second, and then the level will return to full. The channel or address will keep flashing until either the command line is cleared, or **[Next]/[Last]** is used to increment to the next channel or address.

[1]{Flash} - will bring channel 1 to full, then to 15%.

{Address}[1][0]{Flash} - will bring address 10 to full, then to 15%.

Flash On & Flash Off

Pressing **[Shift] & [Full]** together will put all the selected channels at full and “Flash On” will be posted to the command line.

Pressing **[Shift] & [Out]** together will put all the selected channels to out and “Flash Off” will be posted to the command line.

Releasing the keys will return the channels to their previous state.

Using {Move To}

While technically not a manual control instruction, **{Move To}** will be very useful when managing record target data stored from manual control. **[Copy To]** is also a useful function. See “Using [Copy To]” on page 228.

{Move To} allows you to take recorded data from one location and move it to another location. For example:

- **[Color Palette] [1] {Move To} <Color Palette> [5] [Enter]**
- **[Preset] [3] {Move To} <Preset> [8] [Enter]**
- **[Cue] [9] {Move To} <Cue> [2] [Enter]**
- **[Preset] [1] {Move To} [Color Palette] [3] [Enter]**
- **[Int Palette] [5] {Move To} [Preset] [1] [0] [Enter]**

When a **{Move To}** command is given, data is removed from its current location and moved to its new location. If the new location already contains data, a confirmation is required by Ion (unless disabled in Setup). Existing data in the new location will be completely overwritten if a **{Move To}** command is confirmed.

The **{Move To}** softkey appears when a record target type (preset, palette) is indicated on the command line. Some targets (macros, groups, effects, snapshots) only have the **{Move To}** option when viewing in the blind list view. You can also hit **[Copy To] [Copy To]** to access **{Move To}**.

When using **{Move To}** to convert a preset into a palette, all information not relevant for that palette will be removed.

Chapter 7

Using Groups

Groups are channel selection devices used for fast recall of specific channels. A maximum of 1000 groups can be recorded. Once recorded, they are accessible from the keypad, direct selects, and through the displays.

This chapter contains the following sections:

- **Recording Groups Live** 134
- **Selecting Groups** 135
- **Group List** 136

Recording Groups Live

Record groups of channels that you want to have available for fast recall later. Groups can be stored as whole numbers (such as Group 5) or as decimals of tenths or hundredths (such as Group 2.5 or Group 7.65). Only whole number groups can be stored using the direct selects, any decimal designations for groups must be stored using the keypad.

All groups may be labeled. These labels are then displayed on the direct selects as well as in the group list. Group numbers will not display in either until the groups have been created.

The following syntax examples illustrate the various methods and features available when recording groups:

- **[1] [Thru] [5] [Record] [Group] [7] [Enter]** - records only channels 1 - 5 to group 7.
- **[Record] [Group] [7] [Enter]** - records all channels with non-default values to group 7.
- **[5] [Thru] [9] [Record] {Group 7}** - records channels 5-9 to group 7 using the direct selects.
- **[3] [Thru] [8] [Record] [Group] [8] [.] [5] [2] [Enter]** - records channels 3-8 to group 8.52.
- **[-] [3] [Record] [Group] [7] [Enter]** - records all channels, except channel "3," to group 7.
- **[Group] [7] [+] [5] [Record] [Group] [9] [Enter]** - records groups 7 and 5 into group 9.
- **[Group] [8] [Group] [9] [Record] [Group] [1] [0] [Enter]** - records groups 8 and 9 into group 10.
- **[Record] [Group] [7] [Label] [name] [Enter]** - records as above and adds a label to the group.
- **[Record Only] [Group] [7] [Enter]** - records channels with manual data to group 7.
- **[Record Only] {Group 7}** - records channels with manual data to group 7 using the direct select.

Ordered Channels

When recording groups, channels are ordered in the group based on their selection order when the group is stored. This ordering is useful combined with **[Next]** and **[Last]** functions and when applying effects to groups.

For Example:

If you record a group by selecting channels in the following order:

- **[1] [+] [3] [+] [5] [Thru] [9] [Record] [Group] [1] [Enter]**

and later you select Group 1 and press **[Next]**, the channels will be accessed, one at a time, in the same order in which they were initially selected.

If new channels are added to an ordered group using an update command, those channels are added to the end of the channel list from an ordering perspective.

When a group is previewed using the group list, the display defaults to showing the ordered view. Channels can be reordered as needed from this list. Use the **[Format]** key to change to a numeric listing of channels. For another example:

- **[1] [0] [Thru] [2] [Record] [Group] [1] [Enter]**

This will record channels 10 through 2 to Group 1, and then if you select the group you can cycle through the channels using **[Next]** starting with 10, then 9, then 8, and so on.

{Reorder} is an available softkey in the Group List display. Use **{Reorder}** to reorder the channels to numeric order in a group.

Offset

You can use the **{Offset}** softkey to aid in channel selection prior to storing groups. The offset options are **{Odd}**, **{Even}**, **{Reverse}**, and **{Random}**. For example:

- **[1] [Thru] [9] {Offset} {Odd} [Record] [Group] [5]** - records all odd numbered channels between 1 and 9 to Group 5.
- **[1] [Thru] [2] [0] {Offset} {Reverse} [Record] {Group 3}** - records channels 1-20, in reverse order, to Group 3 using the direct selects.

Editing and Updating Groups in Live

Existing groups can be updated or rerecorded in Live. If you rerecord an existing group, a confirmation is required (unless disabled in "Setup"). By rerecording a group, you *replace* the contents of the group, you do not add to it. Updating a group does not require a confirmation and adds channels to the group, rather than replacing them.

Other editing or updating examples are:

- **[Group] [x] [Label] [Label] [Enter]** - clears the label.
- **[Group] [x] [Label] [name] [Enter]** - stores a new label.
- **[1] [Thru] [5] [Update] [Group] [n] [Enter]** - adds channel 1-5 to existing Group n.

For record examples, please see [Recording Groups Live, page 134](#).

Selecting Groups

Groups may be selected from the control keypad or the direct selects.

To select a group:

- **[Group] [1] [Enter]** - selects all channels in Group 1
- **[Group] [1] [At] [5] <0> [Enter]** - selects Group 1 and places all channels within at 50%
- **{Group 1}** - Selects all channels in Group 1

If **[Next]** is used after a group selection, it accesses the first ordered channel in that group. Pressing it again accesses the second ordered channel in that group, and so on. **[Next]** - used after the last channel in the group - accesses the first channel in the group again.

[Last] may be used with group selects similar to **[Next]**. Press **[Select Last]** to reselect the entire group.

Deleting Groups

When you delete a group, the group number and all contents from the Group List Index and direct selects are deleted. Delete commands require a confirmation by default. This can be altered in the default settings. If you disable confirmations, the second enter is not required in the following examples:

Group deletion features include:

- **[Delete] [Group] [5] [Enter] [Enter]** - deletes group 5.
- **[Delete] [Group] [3] [+] [Group] [5] [Enter] [Enter]** - deletes groups 3 and 5.
- **[Delete] [Group] [3] [Thru] [9] [Enter] [Enter]** - deletes groups 3 through 9.
- **[2] [Delete] [Group] [7] [Enter]** - deletes channel 2 from group 7.

Group List

The group list allows viewing and editing of groups.

Open the Group List

To open the group list you can:

- Press **[Group] [Group]**
- In the browser, select “Group List” from the **Record Target Lists**

You can navigate within the group list using **[Next]** and **[Last]** or by selecting the group you want to work with.

Ordered View and Numeric View

By default, grouped channels will be displayed in ordered view. Therefore, grouped channels will appear in the order they were added to the group (see [Ordered Channels](#) above). If you wish to view the channels in numeric view, press the **[Format]** key and the view will be switched (channels will appear in numeric order from lowest to highest).

This setting is important in defining next and last functionality within groups in live/blind. If left in numeric format, when using **[Next]** or **[Last]** group selection channels will be selected in numeric order. If left in ordered view, they will be selected based on their order of being stored to the group.

Editing Groups from the Group List

An existing group can be modified without the need for recording or updating, as follows:

- Select the required group by pressing **[Group] [n] [Enter]**, or using **[Next]** and **[Last]** to navigate through the list.

The selected group is highlighted in gold and above the CIA command line, “BLIND: Group x” is displayed.

The following actions are possible:

- **[Label] [name] [Enter]** - adds or modifies a group label.
- **[Copy To] [Group] [7] [Enter]** - copies the contents of the selected group to group 7.
- **[2] {Insert Before} [9] [Enter]** - inserts channel 2 into the group, placing it before channel 9 in the ordered view.
- **[2] {Insert After} [5] [Enter]** - inserts channel 2 into the group, placing it after channel 5 in the ordered view.
- **[2] [Delete] [Enter]** - removes channel 2 from, the group.
- **[+] <Chan> [1][0] [Enter]** - adds channel 10 to the selected group.
- **[-] <Chan> [5] [Enter]** - removes channel 5 from the selected group.
- **[+][Group] [1][0] [Enter]** - adds group 10 to the selected group.
- **[-] [Group] [5] [Enter]** - removes group 5 from the selected group.
- **{Random} [Enter]** - rearranges the channels in the group randomly.
- **{Reverse} [Enter]** - reverses the order of the channels within the group.
- **{Reorder} [Enter]** - reorders the channels to numeric order in the group selected.

Using Groups as a Channel Collector

[Group] can be used as a quick way to collect channels from submasters, cues, palettes, or presets.

The following actions are possible:

- **[Group] [Cue] [1]** - selects all the channels in cue 1.
- **[Group] [Sub] [3]** - selects all the channels in submaster 3.
- **[Group] [Int Palette] [5]** - selects all the channels in intensity palette 5.

www.carlosmendoza.com.mx

Chapter 8

Storing and Using Palettes

Palettes are building blocks that can be used to create presets, cues and effects. Palettes are a critical component when using moving lights and can save considerable programming time when editing show data.

This chapter contains the following sections:

- **About Palettes** 140
- **Palette Types** 140
- **Palette Options** 140
- **Storing Palettes Live** 142
- **Recalling Palettes** 145
- **Editing Palettes Live** 146
- **Editing Palettes in Blind** 147
- **Using By Type Palettes** 150

About Palettes

Palettes are referenced data. This means that when included in presets, cues, or effects, changes to the contents of the palette are propagated into all of the places the palette is stored. Four types of palettes are available; Intensity, Focus, Color, and Beam. When recording palettes, three softkey options are available.

Ion supports up to 1,000 palettes of each of the four types. Palettes can be recorded as decimal or whole numbers and are automatically filtered into IFCB categories. Color data cannot be placed in beam palettes, intensity cannot be included in focus palettes, and so forth. This makes the process of creating palettes easier, faster and less work. If you need to create a reference that will include a mix of IFCB information, presets can be used. [See “Storing and Using Presets” on page 151.](#)

Palette Types

Intensity Palettes

Intensity palettes can easily be created for use with all channels that have intensity parameter data.

Focus Palettes

Focus palettes can be created for all channels that have pan and tilt functions.

Color Palettes

Color palettes can be created for all channels that have any color parameter data. Color palettes store any combination of color data, including CMY, RGB, and HS settings, color scrollers and color wheels.

You will find that **[Record Only]**, filter settings, and selective store commands will be very useful when storing color palettes.

Beam Palettes

Beam palettes can be created for all channels that have any beam parameter data. It is rare when storing beam palettes that you will wish to include all of the beam parameters for channels. Therefore, **[Record Only]**, filters, and selective store commands will be very useful when storing beam palettes.

Palette Options

{By Type}

By Type palettes are created with 'default' channels which contain values that can be assigned to any other channel within the same fixture type. By Type palettes can also contain discrete channel values.

By Type palettes will display a 'T' in the lower corner of the direct selects. A '+' will display after the 'T' if there are channels stored with discrete data. For more information on by type palettes, see [Using By Type Palettes, page 150.](#)

{Absolute}

Absolute palettes are palettes that when recalled the data is displayed and treated like absolute data applied to a channel. The data is never referenced.

An absolute palette will display with an 'A' in the lower corner of the direct selects.

{Locked}

Locked palettes are palettes that are protected from being accidentally changed in Live.

A locked palette will display a “L” in the lower corner of the direct selects.

Locked palettes can be updated by specifically calling the channels and the record target, [channel list] [Update] [record target] [Enter]. Using [Update] [Color Palette] [1] [Enter] would not work in Live for a locked palette. However locked palettes are not protected in Blind.

Storing Palettes Live

Palettes may be stored in live or blind. There are a variety of methods for determining what data is stored into a palette but **[Record]**, **[Record Only]**, and using filters are the most common ways.

When **[Record]** is used, Ion will store the relevant parameter category data (intensity, focus, color or beam) for all channels that are not currently at their default value.

[Record Only] is a type of selective store that can be used to store only the relevant parameters that have manual data. Filters and selective storing provide additional methods to control what is stored into a palette.

Storing Palettes with [Record]

The most common method to create palettes is to store them from Live. Palettes can be numbered from 0.01 through 1000 and each can be given a label. **[Record]** will store the relevant current parameter data for all channels with non-default data for the appropriate palette type, as modified by the filter settings on the front panel.

For Example:

Assume you want to create a custom color using the color picker (for hue and saturation data) or the encoders (for CMY data) and store that data to a custom color palette. First you must select channels.

- **[1] [Thru] [1] [1] [Enter]**

Using the color picker, adjust the hue and saturation levels to the desired look. Or you can use the encoders to set the desired color using CMY color mixing or the gel picker. When the color is selected, store the palette.

- **[Record] [Color Palette] [4] [Label] <FOH Blue> [Enter]**

Notice that when you recorded the color palette, all of the color data for channels 1 through 11 is displayed in live with the reference "CP 4". Because **[Record]** was used, it stored all of the color parameters for those channels.



Note: ***[Record]** will store the entire parameter category into a palette. **[Record Only]** stores just the values you have adjusted manually to the target palette. See "Storing Palettes with [Record Only]" on page 143.*

When a palette is created, the channels and the parameters involved in the record action are automatically set to the palette reference ("CP 4" in this instance). To view the absolute data for those channels, press and hold the **[Data]** key.

The following methods can be used to store palettes using **[Record]**:

- **[Record] {Color Palette 1}** - stores all color parameter data to color palette "1" and deposits it to the first color palette direct select.
- **[Record] [Focus Palette] [2] [Label] <name> [Enter]** - records focus parameter data for all channels not at their default state and adds a label to focus palette "2".
- **[Record] [Color Palette] [Next] [Enter]** - records data to the next sequential color palette number.
- **[-] [5] [Record] [Beam Palette] [Next] [Label] <name> [Enter]** - stores to the next sequential beam palette, withholding the group or channels specified and adds a label.

Selective Storing Palettes with [Record]

Palettes can also be created using selective storing, which allows you to specify only the channels and or parameters that you want to store.

The following examples illustrate various methods of selectively storing palettes using **[Record]**:

- **[1] [Thru] [3] [Record] [Intensity Palette] [2] [Label] <name> [Enter]** - records the intensity data for selected channels 1 through 3 and adds a label to intensity palette 2.
- **[Group] [2] [Record] [Beam Palette] [Next] [Enter]** - records the beam parameter data for Group 2 to the next sequential beam palette number.
- **[-] [9] [Record] [Focus Palette] [5] [Enter]** - stores the focus data to focus palette 5, excluding the group or channels specified.
- **[1] [Thru] [9] {Iris} {Zoom} [Record] [Beam Palette] [5] [Enter]** - stores all zoom and iris data for channels 1-9 to beam palette 5.



Note:

*When using a selective store, you must specify the channel list to be included or excluded, identified by the **[+]** **[-]** modifier, as part of the **[Record]** command. Otherwise all channels with appropriate non-default data will be stored in the new palette.*

Also, selective storing is useful when you are doing a “one-time” selective store action. If you are recording a series of palettes with only specific parameters, it will save you time to set a record filter (see [Using Filters with Palettes, page 144](#)).

Storing Palettes with [Record Only]

[Record Only] is a selective record process that stores only manual parameter data. When used to record palettes, only the manual parameter data for channels will be stored in the palette. As with record, filters can further restrict stored data if they are enabled when using **[Record Only]**. See [“Storing Palettes Live” on page 142](#).



Note:

*If you use **[Record Only]** to record to an existing palette, the data will be added to that palette. The original palette will not be completely overwritten. Only manual changes will be stored to the palette.*

*It is also possible to **[Update]** to add specific changes to the record target. See [“Editing Palettes Live” on page 146](#).*

The following methods can be used to selectively store manual parameter data to palettes using **[Record Only]**:

- **[Record Only] [Color Palette] [2] [Enter]**- records only the manual color parameter data to color palette 2.
- **[Record Only] [Beam Palette] [5] [Label] <name> [Enter]** - records manual beam parameter data for all channels and adds a label to beam palette 5.
- **[-] [9] [Record Only] [Color Palette] [Next] [Label] <name> [Enter]** - stores to the next sequential color palette, withholding the group or channels specified and adds a label.
- **[select channels] [Record Only] [Focus Palette] [2] [Enter]** - stores focus palette 2, but only includes the manual data for the specified channels and parameters.
- **[1] [Thru] [9] {Iris} {Zoom} [Record Only] [Beam Palette] [5] [Enter]** - stores only manual zoom and iris data for channels 1-9 to beam palette 5.

Using Filters with Palettes

Filters can be used to modify what data is stored to a palette by a record action. The parameters that are active or filtered allow those parameters to be stored to record targets.

To filter a parameter:

- Step 1: Click the **{Filter}** button in the top-right corner of the parameter grid in the CIA.
- Step 2: In the CIA, click the button for the parameter you wish to store.
- Step 3: Click the **{Filter}** button again to stop filter selection. “Filter On” appears next to the parameter category label in the CIA.

To determine which parameter is filtered in the category:

- Step 1: Click the **{Filter}** button in the top-right corner of the parameter grid in the CIA. All actively filtered parameters are highlighted in gray. You may need to click the arrow button in the grid for that parameter category to page to additional parameters in the category.

Filters are a toggle state. To remove filters, click **{Filter}** and then click the highlighted parameter buttons in the CIA to deactivate the filters, or use **{Clear Filters}**.

For more information on filters, see [Using Filters, page 199](#).

Recalling Palettes

Palettes may be recalled from the control keypad or from direct selects. When palettes are recalled, all data is manual and will display in red. Recalled palettes are applied only to selected channels, therefore you must select channels before recalling a palette. If a selected channel or parameter has no stored value in the recalled palette, it remains in its current state. Palettes on direct selects will gray out if they are not applicable for the current channel selection.

You can select all the channels included in a palette by pressing **[Group] [Palette] [x] [Enter]**. You can also recall an entire palette by pressing **[Recall From] [Palette] [x] [Enter]**.

Recalled palettes will appear as manual data for the specified channels. That data will appear as abbreviations of the palette type (IP3 = Intensity Palette 3, FP8 = Focus Palette 8, and so on), or as the palette label if defined/enabled in the displays settings (see [Setup, page 95](#)). To see the numeric values behind any palette (or other referenced value), press and hold the **[Data]** key. To see the palette number behind the label, press **[Shift] + [Label]**.

When palettes are recalled, channels with stored data in the palette will follow that data according to manual time settings. Palettes may also be recalled using a time specified using **[Sneak] [Time]**.

You may also use groups to recall palettes. For example:

- **[Group] [1] [1] [Beam Palette] [5] [Enter]**
- **[Group] [5] {Color Palette 6}**

Palettes may also be recalled from the direct selects which automatically terminates the command line. To recall only specific parameters of a palette, select channels and the required parameters (or those not required, using the **[-]** key) in the command line.

The following are methods that can be used to recall palettes.

- **[selected channels] {direct select}** - recalls the associated (IFCB) palette data for the selected channels.
- **[selected channels] [Palette] [n] [Enter]** - recalls the associated IFCB palette for selected channels.
- **[Channel List] {edge} [Beam Palette] [n] [Enter]** - recalls only the edge data from the specified beam palette for the selected channels.
- **[Group] [n] [Palette] [z] [Enter]** - recalls all of the data in the palette and applies it to the selected group.
- **[Intensity Palette] [y] [At] [/] [z] [Enter]** - recalls the intensity palette for selected channels and sets all recalled intensity values to a proportioned level of their recorded states.



Note: *The above example breaks the referenced link to the intensity palette. To maintain the link, the palette must be recalled without a modified intensity value. Calling back the intensity palette at full will also break this link.*

When recalling palettes, only channels that are selected at the point of recall will be affected by the palette recall. The data recalled from a palette is referenced. To break the reference you may use **{Make Absolute}**.

Editing Palettes Live



Note: *If a palette is already recorded, **[Record]** replaces all existing data. **[Record Only]** is a selective store, therefore it adds data. Recording over a previously existing palette requires a confirmation, if confirmations are enabled in the setup menu. It is also possible to **[Update]** to add manual changes to the record target.*

Rerecord

Rerecording follows the conventions illustrated in the **[Record]** and **[Record Only]** sections detailed earlier in this chapter. The only exception is that a confirmation is required to record over an existing palette.

There are two different methods for rerecording:

- **[Record] [Palette] [5] [Enter] [Enter]** - overwrites the content completely.
- **[Channel List] [Record] [Palette] [5] [Enter] [Enter]**- merges the data.

Update

Live changes can be updated to both active and inactive palettes. When updating a parameter in an active palette, that parameter will no longer be absolute data, but will now be in the updated palette on stage.

The following illustrates how to update color palette 2 when no cues are active and you have recalled channels within that palette.

- **<channel list> [Update] [Color Palette] [2] [Enter]** - any manual changes for channels originally in the palette are updated in color palette 2.
- **[1] [Update] [Color Palette] [2] [Enter]** - adds channel 1's manual data to color palette 2.
- **[-] [3] [Update] {Color Palette 2}** - withholds manual changes for channel 3 from the update to Color Palette 2 using the direct selects.

If a channel or parameter does not have data in the palette being updated, it will not be added to that palette unless the user specifically requests it by specifying the channel.

Editing Palettes in Blind



CAUTION: *When editing palettes in blind, changes to palettes are automatic, therefore no update or record command is required.*

Palettes can be viewed and edited in blind in the table and spreadsheet views.

Entering Blind Palette from Live

- **[Blind]** then press **[Palette]** - pressing this will display the first recorded palette of the selected type (Intensity, Focus, Color or Beam) in blind or return to the last palette of this type viewed in blind.
- **[Blind] {Palette Select 1}** or **[Blind] [Palette] [1] [Enter]** - pressing this will display the specified palette “1” in blind.
- **[Palette] [Palette] {Edit}** - opens the list view of the palette type and then opens blind palette.

View palettes from blind

While in any blind mode, when no channels are selected, you can enter a palette from the command line or direct selects. This will take you into blind channel mode for that palette.

- **[Color Palette] [n] [Enter]**

You may also cycle through the available palettes using **[Next]** and **[Last]**.

Editing in Blind

The following are representative methods used for editing palettes in blind:

- **[2] {Iris} [At] [Enter]** - removes the current parameter category setting from channel 2.
- **[1] {Iris} [5] [0] [Enter]** - selects channel 1 and sets iris value to 50.
- **[2] [Copy To] [5] [Enter]** - copies the information from channel 2 to channel 5.
- **[6] [Recall From] [Focus Palette] [1] [Enter]** - recalls the values for channel 6 from Focus Palette 1 but not the reference.

You may use the encoders to set blind levels as well.

When editing in blind, it is possible to remove an instruction from any palette by selecting the channel and parameter and pressing **[At] [Enter]** or **{Make Null} [Enter]**.

[Recall From], **[Copy To]**, **{Replace With}**, and **{Move To}** may be used to create and edit palette data. See [Advanced Manual Control, page 227](#).



Note: *While editing palettes in blind, hitting **[Recall From] [Recall From]** will put **[Recall From] [Palette]** on the command line.*

Editing Palettes in Spreadsheet View

Spreadsheet view shows a range of palettes along the Y axis and channels and channel parameters along the X axis. Viewing palettes in spreadsheet view is useful when you want to compare data between palettes.

You may select a palette from the spreadsheet using the **[Next]** or **[Last]** keys to move through the list or you may select the exact palette from the keypad. You may also select a range of palettes to edit at once. You can make changes to the palette(s) by selecting channels and altering parameter values. In addition to normal editing functions, you may also use the following commands in this view: **[Copy To]**, **{Make Absolute}**, **{Make Null}**, **{Move To}**, and **{Replace With}**.

The following are representative methods used for editing palettes in blind spreadsheet:

- **[Color Palette] [1] [Thru] [9] [Enter]** - selects color palettes 1 through 9.
- **[1] {Scroller} {Make Null} [Enter]** - sets channel 1 scroller value null in the selected color palette.
- **[1] {Scroller} [4] [Enter]** - sets channel 1 scroller value to 40 in the selected color palette.

In addition to the examples given above, here are some examples of the additional palette editing features you have while editing in spreadsheet view:

- **[palette type] [1] [Thru] [5] {Move To} <palette type> [9] <Thru> [Enter]** - this will move palettes 1-5 to palettes 9-14 respectively. You do not have to supply the end value for Ion to perform the move.
- **[Beam Palette] [1] [Thru] [5] [Enter] {Iris} [5] [0] {Replace With} <Iris> [2] [5] [Enter]** - for palettes 1-5, this command will replace any iris parameter values of 50 with values of 25. This range editing using **[Replace With]** can only be done in spreadsheet view.

Editing Palettes in List View

When you press the specific Intensity, Focus, Color or Beam palette button twice, a list view for the associated palette type is opened on a new tab (or brings the list view into focus if already open). You can also open the list view from the browser. [See "Using the Browser" on page 24.](#)

From the list view, you can select a palette for editing, which changes focus to blind channel view, with the specified palette ready for editing. In addition, you can add palettes to your listing and edit the labels for each palette in the list.

For Example:

In the list view, you can select palettes and relabel or move them.

- **[1] [5] [Label] <name> [Enter]**

While in the specific palette category list view, the **{Move To}** and **{Edit}** softkeys are available for use.

To move a specific palette to a different location:

- **[1] {Move To} [3] [Enter]** - moves the contents and label of the specific palette 1 to palette 3. If palette 3 is already used, you will be asked to confirm that you want to overwrite the existing recorded palette. You can also hit **[Copy To] [Copy To]** to access **{Move To}**.

You can also move data from a preset to a palette and vice versa. It is important to remember that when using the **{Move To}** command that data is removed from its current location and moved to its new location.

To copy a specific palette to a new palette:

- **[2] [Copy To] [5] [Enter]** - copies the contents of palette 2 to the new palette 5.

You can also use **[Copy To]** from presets to palettes.

To edit any palette data from the List View:

- **[1] [5] {Edit} [Enter]** - selects palette number 15 and brings the blind display into focus, with palette 15 selected for editing. You can use the **[Next]** and **[Last]** buttons to access the other palettes, or select a new palette for editing from the keypad.

Deleting Palettes

To delete color palette 1, press **[Delete] [Color Palette] [1] [Enter] [Enter]**. When palettes are deleted, any references in cues will be converted to absolute data.

Removing Channels from a Palette

You can remove specific channels from a palette. This can only be done from blind.

For Example:

Open the palette in blind:

- **[Blind] & [Color Palette]**

Select the palette you wish to edit:

- **[Color Palette] [5] [Enter]**

Remove channels by pressing:

- **[2] [+] [4] [+] [6] [Thru] [9] [At] [Enter]**

You may also remove a channel or parameter from a range of presets by pressing:

- **[Beam Palette] [1] [Thru] [5] [Enter] [6] [At] [Enter]**

You can remove channels from live by pressing:

- **[channel list] [Delete] [Color Palette] [2] [Enter]**

Using By Type Palettes

Storing a By Type Palette

If **{By Type}** is used when recording, the lowest number channel of each fixture type will be the default channel. Generally, when storing by type palettes, you will want only one channel of each fixture type in use. Any additional channels in that fixture type will be recorded with discrete data.

- **[1] [Thru] [5] [Record] [Int Palette] [1] {By Type} [Enter]** - Channels 1 through 5 are saved to Intensity Palette 1. Channels 1 through 5 are of the same fixture type. Channel 1 will be the default channel and channels 2 through 5 will be saved with discrete data.
- **[1] [Thru] [5] [Record] {Intensity Palette 1} [Enter]** - If a by type palette is recorded without using the **{By Type}** softkey and the default channel is included in the record, the default channel's level will change and all other changes will be discrete.
- **[1] [Thru] [5] [Record] {Intensity Palette 1} {Discrete} [Enter]** - If a default channel is included in a record where **{Discrete}** is used and another channel is tracking it, the default channel will be changed to having discrete data and the lowest numbered tracking channel will become the new default channel. All other channels in the record will also have discrete data.

Editing By Type Palettes in Blind

In Blind, the default channel's levels will display in blue, discrete data for the other channels will display in white, and any channels that are using the default channel value will display in magenta.

New softkeys available for editing palettes in blind are **{By Type}**, **{Discrete}**, and **{Cleanup}**.

- **[3] {By Type} [Enter]** - makes channel 3 the new default channel for that device type. If another channel for that type was the default channel, its data will now be discrete.
- **[1] [0] [Thru] [2] [0] {Discrete} [Enter]** - changes the levels for channels 10 through 20 to discrete. If any of those channels are default, the lowest numbered tracking channel will become the new default channel.
- **[5] [Thru] [8] [At] [Enter]** - removes the discrete data for channels 5 through 8. They will now use the default channel's values.
- **[Color Palette] [2] {Discrete} [Enter]** - changes all tracking and default channels to discrete.
- **[Intensity Palette] [5] {By Type} [Enter]** - makes the first channel of each device type a default channel.
- **[Beam Palette] [3] {Cleanup} [Enter]** - converts palettes created in earlier versions of Eos Family software to by type palettes. This command will use the first channel of each type as the default, and allow other channels of the same type to use that value upon recall.

{Make Null} can be used with by type palette when you wish to withhold a channel from responding to a by type palette recall. The data will still display but will be in gray with a "N".

Updating By Type Palettes

Pressing **{By Type}** after an **[Update]** command, with a channel tracking but no default channel included in the update, will cause the lowest numbered tracking channel's level to be updated into the default channel. The tracking channel will remain tracking. This means that when updating a default value in a by type palette, you don't need to know the default channel number.

When a default channel is included in an **[Update]** command without using **{By Type}** and another channel is tracking it, the default channel's data will be changed to discrete. The lowest numbered tracking channel will then become the new default channel. Any other updated channels will be made discrete.

Chapter 9

Storing and Using Presets

Presets are very similar to palettes in that they are collections of data for specific channels to facilitate cue creation. Presets, however, can collect *all* data for a given channel (intensity, focus, color, beam) rather than just one parameter type.

Up to 1000 presets may be stored in Ion using decimals or whole numbers and they can contain absolute data or a mix of IFCB palettes. Presets can *not* refer to other presets.

This chapter contains the following sections:

- **Storing Presets Live** 152
- **Recalling Presets** 154
- **Editing Presets Live** 155
- **Using the Preset List** 156
- **Editing Presets in Blind** 157

Storing Presets Live

Presets can be recorded live using the keypad or the direct selects. Both **[Record]** and **[Record Only]** can be used to record presets, with or without filters. See [“Storing Data with Record Filters” on page 201.](#)

[Record] will store all channels that are not at their default values, and it will record all information about those channels, including parameters that are still at default. Therefore presets can contain all of the same information as a cue, but they have no timing information or cue attributes (such as follow, delay, or cue overrides). When recorded or rerecorded, presets are automatically recalled on stage. Presets may be individually labeled and each has an optional notes field.

Storing Presets Using [Record]

The **[Record]** key will store all parameter data for channels that are not at their default values, as modified by the filter settings in the CIA. This will store all parameter data that is not default even if it is not manual data. If filters are used, only the parameters enabled by the filters are stored.

When you record data to a preset live, the channels involved in that preset will then actually be in that preset.

The following methods can be used to store presets using **[Record]**:

- **[Record] [Preset] [5] [Label] [name] [Enter]** - Records all parameter data for all channels not at default and adds a label to preset 5.
- **[Record] [Preset] [Next] [Enter]** - Records data to the next sequential preset number.
- **[-] [2] [Record] [Preset] [n] [Enter]** - stores the preset, withholding the group or channels specified.
- **[channel list] [Record] [Preset] [6] [Enter]** - stores the preset, but only the data for the channel list supplied.
- **[Record] & {Preset 8}** - stores the preset to the specified direct select.
- **[channel list] {AIINPs} [Record] [Preset] [8] [Enter]** - records all non-intensity parameters for the selected channels to the preset.



Note:

*When using selective record, you must specify the channel list to be included (or excluded as the case may be) as part of the **[Record]** command. Otherwise, all parameters of channels with non-default values will be stored in the preset.*

*You may also use the filters and **{Make Null}** as additional tools to decide what data will be stored. For more information on these features see [Using Filters.](#)*

When you rerecord an existing Preset, a confirmation will be required, unless confirmations have been disabled in Setup.

Storing Presets using [Record Only]

[Record Only] is a selective record process that stores *only manual parameter data*. Therefore, when used to record presets, only manual data for channels will be stored in the preset. As with **[Record]**, filters and **{Make Null}** can be used to further modify what information is stored. See [“Storing Data with Record Filters” on page 201](#).

The following methods can be used to store presets using **[Record Only]**:

- **[Record Only] [Preset] [5] [Label] [name] [Enter]** - records *manual* parameter data for all channels and adds a label to preset 5.
- **[Record Only] [Preset] [Next] [Enter]** - records manual data to the next sequential preset number.
- **[-] [3] [Record Only] [Preset] [n] [Enter]** - stores the preset, withholding the group or channels specified.
- **[Channel list] [Record Only] [Preset] [6] [Enter]** - stores the preset, but only the manual data for the channel list supplied.
- **[Channel list] {Color} [Record Only] [Preset] [7] [Enter]** - stores only manual color data for the specified channels to the preset.

Preset Options

When recording presets, two softkey options are available.

{Absolute}

Absolute presets are presets that when recalled the data is displayed and treated like absolute data applied to a channel. The data is never referenced. An absolute preset will display with an ‘A’ in the lower corner of the direct selects.

{Locked}

Locked presets are presets that are protected from being accidentally changed in Live.

A locked preset will display a “L” in the lower corner of the direct selects.

Locked presets can be updated by specifically calling the channels and the record target, **[channel list] [Update] [record target] [Enter]**. Using **[Update] [Preset] [1] [Enter]** would not work in Live for a locked preset. However locked presets are not protected in Blind.

Recalling Presets

Channels must be selected when recalling a preset. If a selected channel or parameter has no value in the preset, it will stay in its current position. If you want to recall all channels in a preset, you can press **[Recall From] [Preset] [x]**. Presets on direct selects will grey out if they are not applicable for the current channel selection.

If you only want to recall certain parameters of the preset, select channels and enter the required parameters (or those not required, using the **[-]** key) in the command line (see command examples below).

When a preset is recalled, parameter changes will follow the manual timing defaults, if enabled. Any preset which is contributing to live output from Ion is considered to be “active.”

You may recall presets using any of the following methods:

- **{Preset 8}** - recalls the associated preset data for selected channels.
- **[Preset] [2] [Enter]** - recalls preset 2 for selected channels.
- **[Channel List] [Preset] [2] [Enter]** - recalls the preset data for the channels in the selection list.
- **[Channel List] [Color] [Preset] [5] [Enter]** - recalls only the color data from the specified preset for the specified channels.
- **[Color] & {Preset 7}** - recalls just the color data from the specified preset for selected channels.
- **[Recall From] [Preset] [3] [At] [5] <0> [Enter]** - recalls all channels in preset 3, and sets all intensity values at 50%. The original intensity data is still linked to the preset. If the intensity change is desired you must update the preset to maintain the change and the link, or make the data absolute before storing to another record target.
- **[Channel List] [Preset] [7] [Enter] [At] [/] [5] [Enter]** - recalls preset 7 for selected channels. Intensity values will be recalled at 50% of their recorded state. The intensity link is maintained. If the intensity change is desired the user either needs to update the preset to maintain the change and the link, or make the data absolute before storing to another record target.
- **[Recall From] [Preset] [9] [Enter]** - selects all channels with data stored in preset 9.
- **[1] [Recall From] [Preset] [1] [At] [5] [0] [Enter]** - recalls the intensity of channel 1 from preset 1 at 50% of the stored value. If channel 1 was set to 50 in preset 1, it's recalled value would be 25.

Editing Presets Live

There are two ways to edit a preset in Live. You may rerecord the preset or you may use **[Update]**.

Rerecord

Rerecording follows the conventions of **[Record]** and **[Record Only]**. The only exception is that a confirmation is required to actually rerecord the preset.

Two different mode for rerecording:

- **[Record] [Preset] [5] [Enter] [Enter]** - overwrites the content completely.
- **[Channel List] [Record] [Preset] [5] [Enter] [Enter]** - merges the data.

Update

[Update] is used to record parameter modifications back to a preset. When updating, you must specify the preset to be updated. You may do this using the keypad or the direct selects.

For the purposes of the following descriptions, assume that there are no active cues on stage. Updating referenced values while cues are active is covered in [Modifying Cues Live, page 179](#).

For Example:

To update a preset, first recall the preset for any channels you wish to edit.

- **[1] [Thru] [5] [Preset] [1] [Enter]**

or

- **[Recall From] [Preset] [1] [Enter]**

Make required changes to the desired parameters using the keypad or encoders. Once you have achieved the desired look, update the preset.

- **[Update] [Preset] [1] [Enter]**

or

- **[Update] & {Preset 1}**

When updating a preset, only channels that are already in the preset will be updated. You need to select channels or parameters to force new data into a preset when using **[Update]**.

Using the Preset List

The preset list displays all recorded presets. List views only allow you to change attributes; no editing can be done directly in list view. Pressing the **{Edit}** softkey takes you to the blind view of the selected preset, in the last format you used in blind. This will allow you to edit the preset.

You can navigate the preset list using **[Next]** and **[Last]**.

Opening the Preset List

Blind presets can also be viewed in the preset list and can be accessed in a number of ways.

To view the preset list in blind you may:

- Press **[Preset] [Preset]**
- Click on **Preset List** in the **Browser>Record Target Lists**

Move To

You can move presets within the preset list using the **{Move To}** softkey. You can also hit **[Copy To] [Copy To]** to access **{Move To}**.

- **<Preset> [3] {Move To} [8] [Enter] [Enter]** - moves preset 3 to preset 8. Preset 3 will be removed from the list. The second **[Enter]** is not required if you have disabled confirmations in setup.
- **<Preset> [1] [Thru] [5] {Move To} [6] [Enter] [Enter]** - moves presets 1 through 5 to presets 6 through 10.

You can also move data from a palette to a preset and vice versa. It is important to remember that when using the **{Move To}** command that data is removed from its current location and moved to its new location.

Copy To

You can copy presets within the list to another location in the list using **[Copy To]**.

- **<Preset> [2] [Copy To] [9] [Enter] [Enter]** - copies the contents of preset 2 to preset 9. Preset 2 will remain in the list. The second **[Enter]** is not required if you have disabled confirmations in setup.

You can also use **[Copy To]** from palettes to presets.

Editing Presets in Blind

All presets can be viewed and edited in blind. To open a preset in blind, you can do any of the following:

- Press **[Blind] & {Preset x}** - opens to the specific preset
- Press **[Preset] [Preset]** and then **{Edit}** when a preset is selected in the list



CAUTION: *When editing presets in Blind, changes to presets are automatically stored. Therefore no update or record command is required.*

You may change the way you view information in the preset list by pressing the **[Format]** button. This will cycle the preset list through two different views; spreadsheet and table.

Editing in Table View

Table view shows the data for one preset at a time in a table. Channels are displayed on the Y axis and parameters are shown along the X axis. Viewing presets in the table is useful if you want to see data for numerous channels in one specific preset.

To change which preset you are viewing you may use the **[Next]** or **[Last]** keys or you may select the exact preset from the keypad or direct selects. You can make changes to the preset by selecting channels and altering parameter values. In addition to normal editing functions, you may also use the following commands in this view: **[Copy To]**, **{Make Absolute}**, **{Make Null}**, **{Move To}**, and **{Replace With}**.

Here are some examples of the additional preset editing features you have while editing in table view:

- **[select channels or parameters] [Make Abs]** - changes the data for any palette references within the preset into absolute data that no longer references another record target.
- **[select channels or parameters] [Make Null]** - removes the data for the specified channel or parameter from the preset.
- **[select channels or parameters] [At] [Enter]** - removes the data for the specified channel or parameter from the preset.
- **[Preset] [5] {Move To} [Preset] [9] [Enter]** - this will move the contents of preset 5 to preset 9. Preset 9 will be created and preset 5 will be deleted.
- **[Preset] [1] [Copy To] <Preset> [5] [Enter]** - this will copy the contents of preset 1 to preset 5. You may also copy ranges of presets to new locations.
- **[1][Recall From][Preset][1][Enter]** - will recall the contents for channel 1 in preset 1.



Note: *While editing presets in blind, hitting **[Recall From] [Recall From]** will put **[Recall From] [Preset]** on the command line.*

Editing in Spreadsheet View

Spreadsheet view shows a range of presets along the Y axis and channels and channel parameters along the X axis. Viewing presets in spreadsheet view is useful when you want to compare data between presets.

You may select a preset from the spreadsheet using the **[Next]** or **[Last]** keys to move through the list or you may select the exact preset from the keypad. You may also select a range of presets to edit at once. You can make changes to the preset(s) by selecting channels and altering parameter values. In addition to normal editing functions, you may also use the following commands in this view: **[Copy To]**, **{Make Absolute}**, **{Make Null}**, **{Move To}**, and **{Replace With}**.

In addition to the examples given above in table view, here are some examples of the additional preset editing features you have while editing in spreadsheet view:

- **[Preset] [1] [Thru] [5] {Move To} <Preset> [9] <Thru> [Enter]** - this will move presets 1-5 to presets 9-14 respectively. You do not have to supply the end value for Ion to perform the move. If presets 9-14 already exist you will be asked to confirm this move.
- **[Preset] [1] [Thru] [5] [Enter] {Iris} [5] [0] {Replace With} <Iris> [2] [5] [Enter]** - for presets 1-5, this command will replace any iris parameter values of 50 with values of 25. This range editing using **{Replace With}** can only be done in spreadsheet view.

Deleting Presets

You may delete presets in the following ways:

- **[Delete] [Preset] [1] [Enter]**
- **[Delete] [Preset] [1] [Thru] [5] [Enter]**

Presets can be deleted from any screen, at any time. A confirmation is required to delete, unless confirmations have been disabled in Setup.

Removing Channels from a Preset

You can remove specific channels from a preset. This can only be done from blind.

For Example:

Open the preset in blind:

- **[Blind] & [Preset]**

Select the preset you wish to edit:

- **[Preset] [5] [Enter]**

Remove channels by pressing:

- **[2] [+] [4] [+] [6] [Thru] [9] [At] [Enter]**

Or you can remove a specific channel parameter from the preset by pressing:

- **[5] [+] [7] {Color} [At] [Enter]**

You may also remove a channel or parameter from a range of presets by pressing:

- **[Preset] [1] [Thru] [5] [Enter] [1] {Color} [At] [Enter]**

You can remove channels from live by pressing:

- **[channel list] [Delete] [Preset] [2] [Enter]**

Chapter 10

Using Fan

This chapter describes using fan functions.

This chapter contains the following sections:

- **Fanning Parameter Data** 160
- **Fan From the Command Line** 160
- **Fanning References** 161
- **Fanning Timing and Delays** 161

About Fan

Fan provides the ability to spread parameter and timing values in a range across a channel selection set and have those values be evenly spaced. Fan is applied by channel selection or group order. By default, fan operation is from the start channel.

On Ion, **{Fan}** is a softkey. When **{Fan}** is used after a channel selection, the softkeys will repaint to the following fan styles:

- **{Center}** - The middle channel in the order is set as the start and will remain unchanged, and the first and last channels will change in different directions. The level wheel will decrease the lower number channels and increase the higher number channels. **{Center}** only affects the level wheel.
- **{Reverse}** - The selected channel order is reversed before applying the fan.
- **{Mirror}** - The middle channel in the selected order is used as the starting channel and the first and last channels in the order are the end channels.
 - **[5] [Thru] [1][0] [At] [1][0] [Thru] [3][0] {Fan} {Mirror} [Enter]** - sets channel 1 to 30%, 2 to 20%, 3 to 10%, 4 to 20%, and 5 to 30%.
- **{Random}** - The selected channels are put in a random order before fan is applied.
- **{Repeat}** - The number of channels that are fanned before the pattern is repeated.
 - **[1] [Thru] [1][2] [At] [5][0] [Thru] [7][0] {Fan} {Repeat} [3] [Enter]** - sets channels 1,4,7, and 10 at 50%, 2,5,8, and 11 at 60%, and 3,6,9, and 12 at 70%.
- **{Cluster}** - The channels are put into collections, which contains channels with all of the same value.
 - **[1] [Thru] [1][2] [At] [5][0] [Thru] [8][0] {Fan} {Cluster} [4] [Enter]** - sets channels 1 through 3 at 50%, 4 through 6 at 60%, 7 through 9 at 70%, 10 through 12 at 80%.

Fanning Parameter Data

Fan values can be adjusted with either an encoder or via the keypad. To adjust the fan values with an encoder, select the required channels and provide a baseline, if necessary, followed by **{Fan}**.

If no value is entered, the current values will be used. When using encoders to adjust fan, it is not necessary to specify the parameter to be fanned. This is determined by the encoder used.

- **[1] [Thru] [5] {Fan} [Enter]** - selects the channels 1 through 5 and puts encoders and level wheel into fan mode.
- **[1] [Thru] [5] [At] [5] <0> {Fan} [Enter]** - selects the channels 1 through 5, sets a start level of 50% and puts encoders and level wheel into fan mode.
- **[1] [Thru] [5] {Fan} {Mirror} [Enter]** - selects the channels 1 through 5 and puts encoders and level wheel into fan mode with mirror style.

Fan From the Command Line

A level or time command that uses **[Thru]** or a list of references is a command line fan command.



Note: ***{Fan}** is not necessary unless a fan style other than the default is needed.*

To adjust the fan values from the command line:

- **[1] [Thru] [5] [At] [1] <0> [Thru] [5] <0> [Enter]** - sets channel 1 to 10%, 2 to 20%, 3 to 30%, 4 to 40%, and 5 to 50%. This is the default fan adjustment and the **{Fan}** command is not necessary.
- **[1] [Thru] [5] [At] [1] <0> [Thru] [3] <0> {Fan} {Mirror} [Enter]** - sets channel 1 to 30%, 2 to 20%, 3 to 10%, 4 to 20%, and 5 to 30%.

Fanning References

When fanning references, such as palettes, if there are more than 2 reference lists are used then the data will be referenced data. The fan will be repeated if there are more channels than references.

- **[1] [Thru] [5] [Int Palette] [1] [Thru] [3] [Enter]** - sets channel 1 to IP1, 2 to IP2, 3 to IP3, 4 to IP1, and 5 to IP2.

If the list contains 2 or less references, fan will be set to the levels between the references as absolute data.

- **[1] [Thru] [5] [Int Palette] [1] [Thru] [2] [Enter]** - (Intensity palette 1 is all channels at 0% and Intensity palette 2 is all channels set to 100%.) sets channel 1 to 0%, 2 to 25%, 3 to 50%, 4 to 75%, and 5 to 100% as absolute data.

Fanning Timing and Delays

Fanning timing and delays work exactly like fanning parameters.

- **[1] [Thru] [5] [Time] [6] [Thru] [1] [0] [Enter]** - sets the discrete times for channel 1 to 6 seconds, 2 to 7 seconds, 3 to 8 seconds, 4 to 9 seconds, and 5 to 10 seconds.
- **[1] [Thru] [5] [Delay] [6] [Thru] [8] {Fan} {Mirror} [Enter]** - sets the discrete delays of channel 1 to 8 seconds, 2 to 7 seconds, 3 to 6 seconds, 4 to 7 seconds, and 5 to 8 seconds.

www.carlosmendoza.com.mx

Chapter 11

Working with a Single Cue List

When cues are created they are stored in a cue list. By default, recording cues will result in a single cue list, identified as cue list 1. While other cue lists can be recorded in Ion, this chapter deals primarily with working in a single cue list. For more information on multiple cue lists, see [Working with Multiple Cue Lists, page 203](#).

This chapter contains the following sections:

- [Basic Cueing](#)164
- [Recording Cues in Live](#)165
- [Timing](#)169
- [Flags](#)176
- [Modifying Cues Live](#)179
- [Recording and Editing Cues from Blind](#)186
- [Deleting Cues](#)189

Basic Cueing

A cue is a record target comprised of channels with associated parameter data, discrete (channel or parameter level) timing, cue timing, and cue attributes (such as preheat, follow or hang instructions, and so on).

In **Setup**, you have determined if Ion will operate in a Cue Only or Tracking mode. By default, the system is set to tracking, therefore this section of the manual primarily addresses working in tracking mode. The current mode is displayed in the upper left corner of the live/blind display. It is important to know which mode you are working in, as it impacts how cues are edited. [See “Tracking vs. Cue Only” on page 5.](#)

- If your console is set in Track mode (default), changes move forward through the cue list until a block or a move instruction is encountered.
- If your console is set in Cue Only mode, changes to cues have no impact on subsequent cue data.

Cue Numbering

Cues can be numbered from .01 - 9999.99.

Ion provides you with multiple ways to number your cues. The most common methods are listed below:

- After pressing record, enter a cue number which can be a whole number (1) or a decimal number (1.1).
- After pressing record, rather than entering a cue number you may press **[Next]**, which will automatically number the cue with the next sequential number in the cue list. For example, the current cue is numbered cue 1.1, pressing **[Record] [Next]** will automatically number the new cue 1.2.
- When recording decimal cues, it is not necessary to specify the leading cue number if a decimal cue has already been recorded. For example, if the current cue is numbered 5.2, when you enter the next record command, you can just enter **[.] [5]** to record cue 5.5.
 - Whole numbered cue - **[Next]** increments the next whole numbered cue.
 - Tenths numbered cue (.1) - **[Next]** increments in tenths.
 - Hundredths (.01) numbered cue - **[Next]** increments in hundredths.

Recording Cues in Live

When using **[Record]**, all parameters of any lights that have non-default values, either from manual control, other cues, or submaster playback are stored in the target cue.

Channels that have all default values, meaning they have never been changed, are not included in the record action, unless you specifically select the channel and press **{Make Manual}**. Other possible exclusions are parameters withheld by use of filters, or if the channel parameters have been filtered (see [Using Filters, page 199](#)). You can also select individual parameters of individual channels (such as Cyan and Iris) and place them in a null state using the **{Make Null}** button if the values are not needed in the cue you are recording.

Ion is a tracking console, meaning once something is recorded into the cue list, the cue list will always contain information about that channel or parameter unless it is nulled, using the **{Make Null}** command, or filtered using the parameter filters.

When cues are recorded they are automatically played back and manual values are released, unless auto playback on record has been disabled in setup. Upon playback, displayed parameter levels will be color coded for clarification of the record action:

- Blue - intensity has increased from the previous cue or a non-intensity parameter has changed.
- Green - intensity level has decreased from the previous cue or a non-intensity parameter has marked.
- Magenta - level has tracked from a previous cue.
- White - level has been blocked (see [Block, page 176](#)).

Using Record

When the **[Record]** button is pressed the keypad defaults to cue mode; use of the **[Cue]** button is optional. The following are representative examples of recording cues in Live. Once the cue record has been specified, cue attributes such as timing can be combined and entered in any order you wish.

- **[Record] <Cue> [5] [Enter]** - records all parameters of any channels with non-default data into the specified cue number 5.
- **[Record] <Cue> [5] [Label] [name] [Enter]** - records the specified cue and provides an alphanumeric label.



Note:

[+] can be used with **[Record]** to specify a range of cues for recording. See ["Record and Record Only \[+\]" on page 180](#).

Using Record Only

[Record Only] is similar to **[Record]** except that it selectively stores only manually set values, preventing unwanted levels (such as from a submaster or another cue list), from being recorded into the cue. Therefore, when used to record a cue, only the manual data for channels will be stored in the cue. Any values in the previous cue that were unchanged will track into the new cue.

Double pressing **[Record]** will post Record Only to the command line.

All of the same commands used for **[Record]** may also be used for **[Record Only]**.

- **[Record Only] <Cue> [Next] [Enter]** - stores only the manually set values into the next cue in the list.
- **[Record Only] [Cue] [3] [Enter]** - stores only the manually set data into cue 3.
- **[2] [Thru] [8] [Record Only] <Cue> [9] [Enter]** - stores only the manually set data for channels 2 through 8 into the target cue 9.
- **[Group] [2] [Record Only] [Cue] [5] [Enter]**- stores only the manual data from group 2 into cue 5.
- **[selected channels] {Color} [Record Only] <Cue> [4] [Enter]** - stores only the color data for the selected channels into cue 4.

As with **[Record]**, filters can further restrict stored data if deployed when using **[Record Only]**. See ["Using Filters" on page 199](#).

Using Selective Store

You may use the [-] button to withhold information from a cue or use the [+] button to specify a particular channel or parameter to be included in the record action. These actions are both selective stores.

For information on a selective store using filters see [Partial Filters, page 201](#).

Using a Positive Selective Store

You may record only specified parameters into cues. If the cue has already been stored, this action adds the specified channel parameters to the existing cue data.

To record only specific channels into a new target cue:

- **[1] [Thru] [5] [Record] <Cue> [4] [Enter]** - this records only channels 1 through 5 into cue 4.
- **[channel list] [Record] <Cue> [5] [Rem Dim] [Enter]** - this will store the selected channels into the target cue. Any channels active in the previous cue that are not in the selected channel list will be set to zero in cue 5.

To record only specific parameters into a target cue:

- **[1] [Thru] [5] [Focus] [Color] [Record] <Cue> [4] [Enter]** - records the focus and color data for channels 1 through 5 into cue 4. Any other data on stage would not be stored in the target cue.

Using a selective store for a new record target will track in values from the previous cue that are not included in the record action.

Using a Negative Selective Store

It is possible to withhold data from a cue by using the [-] key as follows:

- **[-] [Group] [3] [Thru] <Group> [6] [Record] <Cue> [9] [Enter]** - records the specified cue, with the exception of any channels associated with groups 3 through 6.
- **[-] [3] [Thru] [6] [Record] <Cue> [9] [Enter]** - records the specified cue, with the exception of channels 3 through 6.
- **[-] [Sub] [7] [Record] [Enter]** - records the selected cue, without the input from submaster 7.
- **[-] [Sub] [Record] [Enter]** - as above, except withholds the contents of all submasters.
- **- [Color] [Record] <Cue> [8] [Enter]** - records cue 9 without any color data.

Using [Cue Only / Track]

In Track Mode

When you create a new cue, any unchanged channel parameter data from the previous cue is tracked into the new specified cue. Any changes in this new cue will also track forward into subsequent cues until a move instruction is encountered. The **[Cue Only/Track]** key is an exception to this behavior. When you record a cue in the middle of an existing cue list, using the **[Cue Only]** button will prohibit new information from tracking into the subsequent cue. When you rerecord or update a cue, the modifications will not track forward.



Note:

*In the following examples, the command **[Cue Only]** indicates the same key hit of **[Cue Only/Track]** which is a single button on the keypad. The system setting determines the actual context of the button depending on the mode in which the system is operating.*

For clarity, only the contextual function of the button is used in the examples.

With system set to “Track”

- **[Record] <Cue> [5] [Cue Only] [Enter]** - records cue 5. New values or changes will not track into the subsequent cue.
- **[-] [Color] [Record] <Cue> [5] [Cue Only] [Enter]** - as above the recorded data will not track forward and all color data is excluded from the record operation.
- **[Record Only] <Cue> [5] [Cue Only] [Enter]** - records all manual data, but doesn't allow it to track into subsequent cues.
- **[-] [5] [Record] <Cue> [6] [Cue Only] [Enter]** - records the specified cue, except the contributions from channel 5. The stored data will not track forward in the list.

In Cue Only Mode

When you create a new cue, any channel parameter data from the previous cue is tracked into the new cue. The **[Cue Only/Track]** key can be used as an applied exception to the cue only/track system setting.



Note:

*In the following examples, the commands **[Track]** indicate the same key hit of **[Cue Only/Track]** which is a single button on the keypad. The system setting determines the actual context of the button depending on the mode the system is operating.*

For clarity, only the contextual function of the button is used in the examples.

With system set to “Cue Only”

- **[Record] <Cue> [5] [Track] [Enter]** - records cue 5. This data will track forward in the list until the next move instruction or block.
- **[-] [5] [Color] [Record] <Cue> [6] [Track] [Enter]** - records the specified cue, except the color data from channel 5. The data will track forward in the list until the next move instruction or block.
- **[Record Only] <Cue> [2] [Thru] [7] [Track] [Enter]** - stores all manual data. The stored data will track from cue 2 and stop at cue 7.

Timing

Cue timing can be applied in a variety of ways. At a cue level, timing categories are provided for intensity up, intensity down, focus, color and beam transitions. Each of these times can have an associated delay. Timing can also be applied directly to a channel or a specific parameter. This is called discrete timing.

Time can be entered in minutes and seconds (example 10:15) with valid fade times from zero to 99.59, or seconds and tenths of seconds (example 1.3), or 100ths of seconds (example 1.35) with valid fade times from zero to 99.99. When no time is applied at a cue level, the defaults established in System Setup are used. See “Setup” on page 95.

For Example:

You want the time for cue 1 to be 10 minutes and 15 seconds.

- **[Cue] [1] [Time] [1][0][1][5] [Enter].**

The command line will show the time as:

```
LIVE: Cue 1 : Cue 1 Time 10:15 ◆
```

If you want the time for cue 1 to be in seconds and tenths of a second, like 1.3 seconds, you will type using a decimal.

- **[Cue] [1] [Time] [1].[3] [Enter]**

The command line will show the time as:

```
LIVE: Cue 1 : Cue 1 Time 0:01.3 ◆
```

Setting Cue Level Timing

Unless you specify otherwise, Ion assigns default fade times to any cue you record. Default timing is designated in Setup. Cue level timing can be applied when a cue is recorded or can be added or modified later.

Following are some examples of record commands with cue level timing:

- **[Record] <Cue> [5] [Time] [9] [Enter]** - puts a time of 9 seconds on all parameter timing categories.
- **[Record] <Cue> [6] [Time] [3] [Time] [9] [Enter]** - specifies the intensity up, focus, color, and beam times at 3 seconds and the down time at 9 seconds. The first instance of **[Time]** is used for intensity up fade (meaning intensity value is fading to a higher level than is previously set) and the second instance of **[Time]** is used for intensity down fade time (intensity values fading to a lower level than is previously set).
- **[Record] <Cue> [2] [Time] [Enter]** - resets time to default value. If the cue is recorded with split time, this command only resets the upfade time.
- **[Record] <Cue> [2] [Time] [Time] [Enter]** - unsplit the time and makes it the same as up.



Note: *Unless FCB timing is specifically set, it always defaults to the up fade time value.*



Note: *If a cue is provided split fade times with no delay on either side, and those times are later the same values, the split time is cleared.*

Manual Timing at a Cue Level

It is possible to assign a time of “manual”, for manual parameter transition through the associated fader. See “Cue Playback” on page 215. Manual times are assigned by using the **{Manual}** softkey that is displayed when recording a cue.

- **[Record] <Cue> [4] [Time] {Manual} [Enter]** - applies a manual time. If the cue had previously been given split times, would apply a manual to the upfade, focus, color, and beam times. If the cue had a single time, all of the timing would be “manual” and controlled by the fader.
- **[Record] <Cue> [4] [Time] [Time] [Manual] [Enter]** - applies a manual intensity time to the downfade.
- **[Record] <Cue> [4] {Color} [Time] [Manual] [Enter]** - applies a manual time to any color data changes in cue 4.

Non-intensity Parameter Category Timing

Timing can also be applied for focus, color, and beam parameter categories at a cue level. By default, FCB timing is the same as intensity upfade time. Once FCB timing is different than intensity upfade time, those times are no longer affected by intensity upfade changes.

When you apply a time to an individual parameter category and that category has no movement, the time is displayed in gray. The specified timing will remain in gray until that category is provided with a move instruction, at which point it the timing will display in white.

- **[Record] <Cue> [2] {Color} [Time] [7] [Enter]** - records cue 2 with a cue level color time of 7.
- **[Record] <Cue> [2] {Color} [Time] [Enter]** - resets the color time of cue 2 back to the default value.
- **[Record] <Cue> [2] [Time] [Time] [Time] [7] [Enter]** - records cue 2 with a cue level focus time of 7. In this example, each press of the **[Time]** key steps through each timing value (up time, down time, focus time, color time and beam time).
- **[Record] <Cue> [2] [Time] [7] [Enter]** - records cue 2 and puts a time of 7 on all parameter categories (if FCB all had the same times to begin with).



Note:

It is not necessary to rerecord a cue to alter stored timing data. You can simply redefine the time by specifying the cue and re-entering the time value(s).

- **[Cue] [5] [Time] [8] [Enter]** - Redefines the all category times to 8 seconds (If FCB all had the same timing).
 - **[Cue] [2] {Color} [Time] [5] [Enter]** - Redefines color time to 5 seconds.
 - **[Cue] [3] {Focus} [Time] [-] [2] [Enter]** - Removes 2 seconds from the current time.
 - **[Cue] [7] {Beam} [Time] [+] [3] [Enter]** - Adds 3 seconds to the current time.
-

Delay Time

Delay can be useful when you do not want a parameter to change (for example - intensity down) until other changes have begun or completed their transition.

Delay times can be added to any cue or to any specific parameter category within the cue, which will postpone the parameter transition until the delay time has elapsed.

Following are some examples of recording with a delay:

- **[Record] <Cue> [2] [Delay] [5] [Enter]** - stores cue 2 with a 5 second delay on intensity.
- **[Record] <Cue> [2] [Time] [9] [Delay] [3] [Enter]** - records cue 2 with a 9 second upfade, delayed from Go by 3 seconds.
- **[Record] <Cue> [2] [Time] [7] [Delay] [Enter]** - records cue 2 with a 7 second upfade, and removes a delay time on the upfade.

Delay can be used to affect only the parameters in the specified category.

- **[Record] <Cue> [2] [Color] [Delay] [8] [Enter]** - records cue 2 with a delay time of 8 seconds for the color category.

For information on delaying effects, see [Delaying Effects, page 255](#).

[Time][/]

The **[/]** key can be used with **[Time]** to control the intensity upfade and downfade times, and delays.

- **[Cue] [1] [Time] [/] [5] [Enter]** - places a downfade time of 5 on the cue, while splitting the upfade, which preserves its current value.
- **[Cue] [2] [Time] [/] [Enter]** - removes the downfade time and makes the downfade match the upfade.
- **[Cue] [3] [Time] [4] [/] [Enter]** - sets the upfade time, and splits the downfade without splitting the FCB times.
- **[Cue] [5] [Time] [4] [/][3] [Enter]** - sets the upfade and the downfade times.
- **[Cue] [4] [Time] [2] [/] [/] [Enter]** - changes only the intensity upfade time and splits the downfade and FCB times preserving their current value.

Discrete Channel or Parameter Timing

Rather than using cue times, timing can be applied directly at a parameter or channel level. This is referred to as discrete time.

Discrete timing can be applied to a specific channel or parameter. You must select the channels that you want to apply the time to, otherwise the system assumes you are addressing the selected cue.

Following are some examples of use:

- [channel list] [Color] [Time] [3] [Enter] - adds a time of 3 seconds to all of the color parameters of the channel list that have a move instruction.
- [Frost] [Time] [7] [Enter] - assigns a time of 7 seconds for the frost attribute of all selected channels.
- [Select last] [Frost] [Time] [7] [Enter] - selects the last channel selection and applies a time of 7 to any manual frost values.

Discrete delay times can also be placed on a channel parameter.

- [1] {Color} [Time] [4] [Delay] [3] [Enter] - places a time of 4 seconds and a delay of 3 seconds on all color parameters of channel 1.

The [+] and [-] hardkeys can be used to increase or decrease discrete timing values.

- [channel list] [Time] [+] [3] [Enter] - increases the discrete timing values by 3 seconds.
- [channel list] [Delay] [-] [1] [Enter] - decreases the discrete delay value by 1 second.

When timing has been applied to a channel parameter in live, a small red "t" will be displayed with the channel. This indicates the timing must be stored or updated to the required cue. When this is done, the "t" is displayed in blue. In the Playback Status Display, a "+" is displayed in the associated parameter category time field, indicating that not all of the parameters in the cue will use the cue timing. The [Shift] & [Time] keys can be held down to see the discrete delay or time information for channels in Live/Blind. Delay is displayed first, followed by the timing value.



Note:

Reminder that any conditions placed on channel/parameter in live (such as discrete timing, asserts, blocks, etc) must be stored or updated to the cue.

Assigning Cue Attributes

You can record cues with specific attributes to affect how cues behave when executed. Cue attributes include follow time, hang time, link, loop, curve, rate and label. Cue attributes can be entered when the cue is initially recorded, or they can be added or modified at a later date.

Follow/Hang

A follow time creates an auto-follow which automatically activates the next cue in the sequence when the follow time of the associated cue has elapsed. The follow time begins counting from the moment the cue is executed.

The hang time is also an auto-follow, but rather than counting from the moment the cue is executed, it is calculated from the completion of the cue. You can assign a negative value to a hang time, allowing a subsequent cue to overlap an active cue.

You can assign either a follow time or a hang time, but not both. Both features are accessed using the **[Shift] & [Delay]** keys on the console or the softkey **{Fw/Hg}**. **[Shift] & [Delay]** or **{Fw/Hg}** will put Follow on the command line, and **[Shift] & [Delay] [Delay]** or double pressing **{Fw/Hg}** will put Hang.

Following are some examples of use:

- **[Record] <Cue> [5] [Shift] & [Delay] [8] [Enter]** - records cue 5 and provides a “follow” time of 8 seconds which impacts the start of the next cue in the list. The following cue will automatically initiate on the same fader when the follow time has elapsed. The follow time will begin counting down when the associated cue (Cue 5) is executed.
- **[Record] <Cue> [5] [Shift] & [Delay] [Delay] [8] [Enter]** - records cue 5 and provides a “hang” time of 8 seconds which impacts the start of the next cue in the cue list. The following cue will automatically initiate on the same fader when the hang time has elapsed. The hang time will begin counting down when the associated cue (Cue 5) is complete.
- **[Record] <Cue> [5] [Shift] & [Delay] [Delay] [-] [5] [Enter]** - records cue 5 and provides a “hang” time of negative 5 seconds.

To remove a Follow/Hang time:

- **[Cue] [x] [Shift] & [Delay] [Enter]**

Link/Loop

Link allows cues to be run out-of-sequence, by causing a different cue number to be loaded into the pending file of the playback fader when the cue that carries the link instruction is activated. If a follow or hang time is included with the cue attributes, the activation of the linked cue will occur when the follow or hang time has elapsed. The link can be within the cue list or to a cue in another cue list.

Following is an example of using link:

- **[Record] <Cue> [2] {Link/Loop} <Cue> [8] [Enter]** - records the specified cue 2 and provides a link to cue 8 in the cue list. When cue 2 is played back, the linked cue is loaded into the pending file of the associated fader.

Loop is provided as a method to link a series of cues and loop them a number of times in a sequence. Once the sequence of cues has played back the first time, the system recognizes the loop command and plays the sequence again.

If the first cue in the sequence is a cue with an assert attribute or has move instructions for channels, values from the last cue are not allowed to track through into the first cue when it is looped back. But without a move or assert in the first cue, values from the last cue will track into the first cue when it loops back. A loop specified with "0", loops the sequence indefinitely.

Following is an example of using loop:

- **[Cue] [2] {Link/Loop} <Cue> [1] {Link/Loop} [3] [Follow] [4] [Enter]** - records a link from cue 2 back to cue 1. Because there is a follow time, cue 1 will automatically trigger 4 seconds after cue 2. If cue 1 also has follow time, it will automatically trigger cue 2. This sequence will run 4 times (once plus 3 loops) and then stop in cue 2. The loop value specifies the number of times the loop instruction will be performed. Since the sequence has run once prior to the loop command, the total number of passes will be the specified number of loops +1.

Rate

The **{Rate}** softkey can be used to apply a rate adjustment to all timing in the cue. The default rate is 100%, which is real time. To slow a cue down, set the rate below 100%, to speed the cue up, set the rate above 100%. The range rate for a cue is 0 - 2000%. A timing value of 5, with a rate of 50% will replay in 10 seconds. A timing value of 5, with a rate of 200% will replay in 2.5 seconds.

Following is an example of using rate:

[Record] <Cue> [4] {Rate} [1] [2] [5] [Enter] - records the specified cue, and places a rate override instruction on all timing values. The cue would now be played back at 125% of recorded time values.



Note:

You can use the playback rate override function to determine the rate at which you want to play the cue back, and then apply that rate to the cue. This eliminates the need to adjust all of the timing in the cue if you only need to speed it up or slow it down. See "Using Rate Override" on page 225.

Curve

{Curve} is used to affect the percent completion of a cue or part by applying the curve's output level as the percent completion for all fade calculations.

Following is an example of how to assign a curve to a cue:

- **[Cue] [6] <More SK> {Curve} [5] [Enter]** - applies curve 5 to cue 6.

When a curve is applied to cue, it impacts only the intensity transitions in that cue. When applied to a cue part, it impacts any parameters moving in that part. For more information on creating and using curves see [Storing and Using Curves, page 277](#).

Label

[Label] is used to attach an alphanumeric label to a cue or cue part.

Following is an example of how to apply a label to a cue:

- **[Record] <Cue> [7] [Label] <name> [Enter]** - records cue 7 and applies the label as entered on the alphanumeric keyboard.
- **[Record] <Cue> [8] [Label] [Block] [Enter]** - records cue 7 and applies the name of the hardkey as the label

Pressing **[Label]**, when a label has already been applied to a cue, will display the label on the command line for editing. Pressing **[Label]** a second time will clear the label, or you can press **[Clear]** to remove the label one character at a time.

Clearing Cue Attributes

To clear attributes from a cue:

- **[Cue] [n] [Shift] & [Delay] [Enter]** - removes the follow or hang time from the specified cue "n".
- **[Cue] [n] [Label] [Label] [Enter]** - removes the label from the specified cue "n".
- **[Cue] [n] {Link/Loop} [Enter]** - removes the link instruction from the specified cue "n".
- **[Cue] [n] [Thru] [y] {Rate} [Enter]** - removes the rate instruction in cues "n" through "y".

You may combine these to remove multiple attributes at once:

- **[Cue] [n] [Shift] & [Delay] {Link/Loop} [Enter]** - removes the follow time and link instruction.

Flags

Flags can be applied to cues to change specific behaviors. Flags can be set for “Block”, “Assert”, “AllFade”, “Mark”, and “Preheat”.

Block

You can apply a block to a cue, a cue part, to any channel (or group of channels), or parameter (or group of parameters) within a cue. Block is an editing function, it has no impact on how the data is played back.

At a cue level

A cue level block causes all tracked values in the cue to be treated as move instructions for editing purposes, which prohibits any data changes from tracking into the cue. Parameters that are not included in the cue are not impacted by the block instruction.

Blocks do not protect a cue, channel or parameter from being modified by a range edit, nor are they protected from a trace instruction (see [Using Trace, page 184](#)). It is assumed that if you use the trace instruction, then you really want the initial value to change. A block will stop the trace from moving any further backwards through the cue list.

Ion also supports an “auto-block” function. Auto-block can protect your cue data from unwanted changes. For example, in cue 5 you set channel 1 to 50%. It is stored as a move instruction. Then, you later go back to an earlier cue and set channel 1 to 50% and it tracks forward to cue 5. Channel 1 will be “auto-blocked” in cue 5. Even though it is now at the same value as the previous cue, the original concept of a move instruction is maintained.

Blocks that you have applied will display parameter data in white. Auto-blocks are displayed in white, with a white underscore.

- **[Cue] [5] [Block] [Enter]** - “B” is displayed in the flags field, indicating a cue level block. When this cue is recalled, all data that would otherwise appear as a tracked value, will be displayed in white. Any changes upstream in the cue list will not impact this “blocked” cue data.
- **[Cue] [6] {Intensity} [Block] [Enter]** - “I” is displayed in the flags field, indicating a cue level intensity block.

At a Channel or Parameter Level

Blocks can also be applied to a channel or a channel parameter. This can be done in live or blind. When applied in live, the block instruction must be stored or updated to the appropriate cue.

- **[9] [Block] [Enter]** - applies a block to channel 9. A red “B” appears near the channel in the live display, indicating a block has been applied but is not yet stored.
- **[Group] [5] [Color] [Block] [Enter]** - applies a block to all of the color parameters for group 5.

When the block instruction has been stored or updated, any tracked values the block was applied to will be displayed in white.

Channel level blocks and auto-blocks are indicated in the cue list by a “b”, representing a partial block.

Assert

Assert is a way to make a tracked or blocked value act as a move instruction on playback. It is often used in a multiple cue list environments, or to assure that a transition happens in the desired time. See [Using Assert, page 204](#) for more information on asserts in multiple cue lists.

Assert can be useful in a single cue list.

For Example:

Cue 10 is a blackout with a zero count. It is common practice to block blackout cues. Let's say though that some of the lights were fading to zero in cue 9. You hit **[Go]** for cue 10 before cue 9 is finished. The lights that were fading to zero in cue 9 will continue their downfade in the timing for cue 9 since cue 10 doesn't provide them with a new move instruction. If you assert cue 10, the lights will bump to black as expected.

AllFade

Any cue can have an allfade flag applied. An allfade sends the intensity for all channels not included in the cue to zero. Submasters, any captured channels and the contribution from any faders that are set to independent are unaffected, unless the cue executing the allfade is also set to independent. An allfade flag "*" is identified in the playback status display for the specified cue.

- **<Cue> [5] [Allfade] [Enter]** - sends intensity for all channels not included in the allfade cue to zero.

The allfade instruction is useful as a quick cleanup, to get back to a known state on stage, without having to worry about what channels need to be set to zero.

Mark

The Mark flag is used to relay information about either automarks or reference marks. When using automarks, an "M" will display in the flags field for the specific cue that will execute an automark. A "D" is displayed when automark has been disabled for a cue or a cue part.

When using reference marks, an "M" will display in the flags field for any cue that will execute a referenced mark. An "R" displays when a cue is the source of a mark. See ["Using Mark" on page 191](#).

Preheat

Preheat can be used to warm filaments in the cue immediately preceding an intensity upfade from 0. Preheat values can be assigned channels individually in patch (see [{Attribute} Display and Settings, page 73](#)).

Preheat is assigned on a cue (or cue part) basis and, if assigned, any channel in that cue with a preheat value assigned in patch will fade to that intensity in the cue immediately preceding the cue with the preheat flag. Cues with a preheat flag will display an "P" in the preheat flag column (indicated by a "P" at the top of the column).

When a channel is in a preheat state, a "Ph" is displayed in the intensity field of that channel. When a preheat is executed, the preheat value is established using the upfade time of the associated cue. It is possible to hold the **[Data]** key to see the actual preheat values.

Using External Links

External links can be used to trigger actions such as macros, show control, or snapshots. Additionally, you can enter instructions that sync the “Go” of other cue lists.

When you press **{Execute}**, the softkeys will change to **{Time Code}**, **{Macro}**, **{Relay}**, **{On}**, **{Off}**, **{Snapshot}**, **{OOS Sync}**, **{MIDI Raw}**, and **{String}**.

To trigger a macro:

- **[Cue] [1] {Execute} [Macro] [5] [Enter]** - triggers Macro 5 when cue 1 is executed.

To trigger a snapshot:

- **[Cue] [3] {Execute} {Snapshot} [3] [Enter]** - loads snapshot 3 when cue 3 is played back.

To trigger a relay either on or off:

- **[Cue][5] {Execute} {Relay}[1] [/] [1] {On} [Enter]** - triggers relay 1/1 on (ACN Group ID / Relay Number).

To trigger cue lists press:

- **[Cue] [1] {Execute} {Cue} [4] [/] <+> [6] [/] [Enter]**
- **[Cue] [1] {Execute} {Cue} [2] [/] [Thru] [5] [/] [Enter]**

To trigger a specific cue on another fader:

- **[Cue] [4] {Execute} [Cue] [4] [/] [5] [Enter]**

When cue list triggers are set, the system will automatically execute same numbered cues on the associated cue list. For example, assume that the last instruction above was applied to cue list 1, cue 1. When cue 1/1 is executed, any cues numbered “1” in cue list 2 thru 5 will be executed accordingly. If there is not a cue 1 in those lists, no action is taken on them. If there are cue numbers on secondary cue lists that are not in cue list 1, those cues are skipped and the subsequent cue taken as an “out-of-sequence” cue when triggered.

When cues are taken on the primary list out of sequence, only like-numbered cues on the secondary lists will be replayed. For example, if you go to cue 12 on the primary list, and there is a cue 12 on the secondary list, cue 12 on all lists is executed. However, if cue 12 does not exist in the secondary list, that list will be unaffected by the go to cue command. Out of sequence sync can be enabled to make sure secondary lists assume the same position in the show as they would on linear playback.

{OOS Sync} can be used to change that behavior per cue list. **{OOS Sync}** is disabled by default. When enabled, OOS Sync will display in the cue list index’s external links column. **{OOS Sync}** should be enabled in the secondary lists, not on the list that contains the execute command.

When OOS Sync is enabled, any out of sequence cue fired from a cue list that is synced with another cue list will trigger the closest earliest cue that exists if the correct cue does not.

For Example:

Cue list 1 is synced with cue list 2. Cue 1/3 is fired. Since cue 2/3 does not exist, cue 2/2 will fire instead. If OOS Sync was disabled, a cue in cue list 2 would only fire if it has the same cue number as cue list 1.

Removing a trigger:

To remove a trigger, access the cue number and press **{Execute}**, the record target type and press **[Enter]**.

- **[Cue] [5] {Execute} {Cue/Macro/Snapshot} [Enter]**

Modifying Cues Live

Recorded cues can be modified live. Cue attributes (such as link, loop, label and so on) may be edited as well. The cue does not need to be active (played back) to change cue attributes. You may also change cue attributes for a range of cues if you wish.

Using [At] [Enter]

A useful feature when editing cues is **[At] [Enter]**. This is a simple feature which allows you to select any channel or parameter, or several of them, and remove their move instructions, allowing the value from the previous cue to be manually recalled.

[At] [Enter] is essentially a “recall from the previous cue” command; it completely removes a move instruction and any manual data, and replaces it with the value from the previous cue.

For Example:

Cue 5 is active in Live.

- **[Group] [1] [Focus] [At] [Enter]**

This command lifts the current move instructions for Group 1 focus, and recalls the focus data for those lights from the immediately preceding cue. It is now manual, and can be stored or updated as required.

You may also use **[At] [Enter]** to affect only certain channels or parameters by selecting them specifically:

- **[2] [At] [Enter]** - this will remove the changes for channel 2 only.
- **[2] [Color] [At] [Enter]** - this will remove only the color data changes for channel 2.
- **[2] [Thru] [5] [+] [9] [+] [1] [1] [Thru] [1] [5] [-] [1] [2] [-] {Zoom} [At] [Enter]** - removes the changes for only the selected channels for all parameters except zoom.

Using Record

You may modify a cue by rerecording it entirely. After making changes to channels or parameters:

- **[Record] [Enter] [Enter]** - will replace any data in the active cue with the current stage settings.
- **[Record] [Cue] [x] [Enter] [Enter]** - will replace the any data in cue “x” with the current stage values.
- **[1] [Record] [Cue] [2] [Enter] [Enter]** - will only record the changes to channel 1.



Note:

*Using **[Record]** will record all parameters of all non-default channels onstage. This means that all other cue data and submaster data will be included in the record action.*

*This is a common method when working with a single cue list. When working with multiple cue lists or submasters, **[Record Only]** is a useful tool.*

Using Record Only

Modifying existing cues using **[Record Only]** is considered a “selective store” function. As such, it adds or modifies only manual data to the target cue, but leaves any other data that was already in the cue intact and does *not* include playback values from other cue lists or submasters. **[Record Only]** is a good way to modify existing cues without including contributions from other playbacks in the cue. In that way, it is very similar to update.

- **[Record Only] [Enter] [Enter]**- adds the current manual data to the selected cue.
- **[Record Only] [Cue] [x] [Enter] [Enter]** - adds the current manual data to cue “x”.

Record and Record Only [+]

[+] can be used to specify a range of cues when using **[Record]** and **[Record Only]**.



Note: *If no cue number is entered before the [+], the current active cue will be used.*

For Example:

To record only cues 5, 10, and 15:

- **[Record] <Cue> [5] [+ <Cue> [1][0] [+ <Cue> [1][5] <CueOnly/Track> [Enter]**

To update the current cue and cue 7:

- **[Record Only] [+ <Cue>[7] <CueOnly/Track> [Enter]**

Move To

You can use the command **{Move To}** to move a cue from one location in the cue list to another.

- **[Cue] [4] <More SK> {Move To} <Cue> [8] [Enter]** - moves the contents of cue 4 to cue 8. Cue 4 is removed entirely. If cue 8 already existed, a confirmation will be required before replacing cue 8 (unless confirmations have been disabled in setup). Any contents of cue 8 will be replaced entirely.

[Update]

Update is a powerful feature, and also very versatile. Using a combination of **[Cue Only]**, **[Track]**, **[Trace]**, and **{Make Absolute}**, the number of ways you can update specific information and manual data is virtually endless. Below you will find some examples of how data can be updated to various record targets either at once, or individually. This list is by no means exhaustive, so you are encouraged to try methods of updating on your own.

Update Dialogue Box

When you press **[Update]**, a dialogue box will open in the CIA. Update styles and modifiers for those styles will be divided in the Update Dialogue Box.

Update Styles

- **{All}** - this button will update the target cue and all references stored to that cue (nested and otherwise).
- **{Make Absolute}** - this button will update the target cue and convert all levels to absolute values, thereby removing any references.
- **{Ref Only}** - this button will only update the palettes or presets used in the cue, but will not update the cue itself. If a manual reference was used before using **{Ref Only}**, the last manual reference will be updated.

Update Modifiers

- **{Last Ref}** - this button will update using the last reference that was applied.
- **{Break Nested}** - this button will update the target cue and any presets used, but breaks the reference to any palettes nested in a preset. For example, if cue 1 channel 1 references preset 3, and preset 3 was built using color palette 5. When updated with this option, preset 3 would be updated, color palette 5 would not, and the reference to CP5 would be broken in preset 3.
- **{Reset}** - this button will clear any commands after the **[Update]** command to quickly undo pending changes before **[Enter]** is pressed.

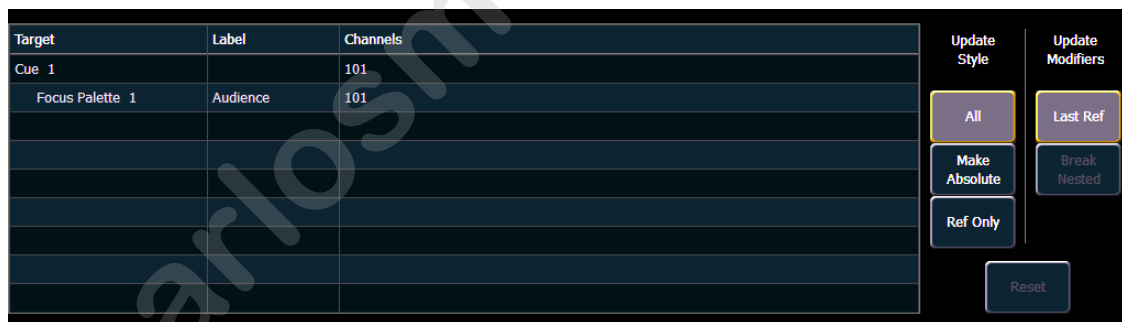

Update Dialogue Box

The dialogue box also provides you with a listing (by record target) of what channels/parameters will be impacted by the update instruction. If the channel contains a reference in the cue, it is indicated. If not, a "+" is displayed. Channels that have been manually added to the stage output, but are not overrides of an active cue will update to the selected cue list.

Once you have made a selection from the available options, press **[Enter]** and the target will be updated.

Targets may be deselected from the dialogue box, excluding them from the update without specifying the target number, for example, **[Update] [Color Palette] [Enter]**.

Default Update Modes

You can define the default update modes in setup. The Update Setup options are under **Browser>Setup>Desk Settings>Record Defaults**. Ion defaults to Update All for the **{Update Mode}**, with **{Break Nested}** and **{Update Last Reference}** disabled.

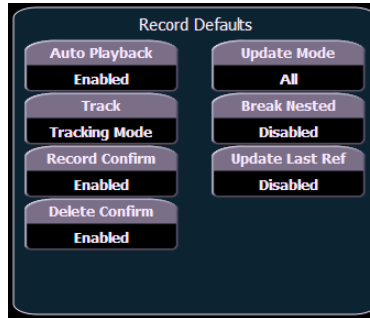

Default Update Setup Options

Updating to References

When a cue is active, it is possible that various record targets (palettes or presets) will be played back within that cue. As changes are made to the data in that cue, as well as to the individual palettes or presets, updating both the cue and references within that cue is simple. When you have overridden a reference in a cue, the data is displayed in red with a red “R” in superscript next to the channel’s intensity.

By default, Ion updates any referenced data that was included in the cue.

For Example:

Cue 5 is recalled Live. It contains references to color palette 1 and preset 2. You make changes to channels included in these record targets. To update both the cue *and* the palettes or presets, press:

- **[Update] [Enter]**

This will automatically take the manual changes and update them to color palette 1 and preset 2. Therefore cue 5 now references these new values, and the modifications to CP1 and PR2 have propagated through all of the show data.

If you had made changes to other channels that were not included in the palettes or presets used in cue 5, those values would also be updated to the cue as absolute data.

Updating Without References (Make Absolute)

If you want to record your changes to the cue *without* updating the references, you may use **{Make Absolute}** break the associated to the reference. The **{Make Absolute}** command can be applied to the required channels or parameters before the update instruction, or they can be applied during the update.

- **[Update] {Make Absolute} [Enter]** - breaks the references for any parameters which have been changed and update the cue with the changes. The referenced target will no longer be displayed in the channels which were made absolute. All of the data updated in cue 5 will now be shown as absolute data.
- **[5] [Thru] [9] [Update] {Make Absolute} [Enter]** - breaks only the references for channels 5-9 and record their manual values to the cue. Other manual values will not be included in this update.

You may also use **[Record Only]** to break references.

For Example:

Cue 5 is active and onstage. Channels 5-20 are currently referencing preset 1. You make changes to channels 5-9. The data for these changes is now manual. Press:

- **[Record Only] [Enter] [Enter]**

If there were other changes on stage, you could have commanded:

- **[5] [thru] [9] [Record Only] [Enter] [Enter]**

Only the manual data will be recorded as an update to cue 5. The reference to preset 1 for channels 5-9 is broken and now the cue will display the absolute data rather than the reference indicator.

Update Break Nested

This is used only when presets that have embedded palette data are modified in a cue. If you wish to maintain the link to the preset, but not impact the palette that was the source of the preset, **[Update] {Break Nested}** can be used.

Using Cue Only/Track

The **[Cue Only/Track]** key can be used as an applied exception to the cue only/track system setting. Therefore if the system is set to Cue Only, the key behaves as a **[Track]** command. Alternatively, if the system is set to Track, the key behaves as a **[Cue Only]** button.

For more information on Tracking vs. Cue Only see [Tracking vs. Cue Only, page 5](#) in Setup.

[Cue Only/Track] can be used in conjunction with record or update functions. Following are some examples of use:



Note:

*In the following examples, the commands **[Cue Only]** and **[Track]** indicate the same key hit of **[Cue Only/Track]** - a single button on the keypad. The system setting determines the actual context of the button.*

For clarity, only the contextual function of the button is used in the examples.

With system set to “Track”

- **[Record] <Cue> [5] [Cue Only] [Enter] [Enter]** - rerecords cue 5. This will make the changes to cue 5 *only*. The changes will not track forward through the list.
- **[-] [Color] [Record] <Cue> [5] [Cue Only] [Enter] [Enter]** - as above, but changes to color parameters will not be included in the record and all data that was included will not track forward. Color data in the cue remains unchanged.
- **[Update] <Cue> [5] [Cue Only] [Enter]** - updates cue 5 with only those manual parameters that were receiving their instructions from that cue. The changes will not track forward in the list. Note that if the data being updated were referenced, this action updates the referenced target as well.
- **[-] [5] [Record] <Cue> [7] [Cue Only] [Enter] [Enter]** - rerecords the specified cue, except the contributions from channel 5. The changes will not track forward in the list.

With system set to “Cue Only”

- **[Record] <Cue> [5] [Track] [Enter] [Enter]** - rerecords cue 5. This will force the changes to track forward in the list until the next move instruction or block.
- **[-] [5] [Color] [Record] <Cue> [7] [Track] [Enter] [Enter]** - rerecords the specified cue, except the color data from channel 5. The recorded changes will track forward in the list.
- **[Update] <Cue> [3] [Thru] [7] [Track] [Enter]** - updates cues 3 thru 7. Range updates are subject to the normal rules of track/cue only in determining impact on subsequent cues.

Using Trace

{Trace} works just as Track does, except it allows changes to be tracked backwards through the cue list, until it sees a move instruction. A trace will track into, but not beyond, a blocked instruction.

Following are some examples:

- **[Update] <Cue> [5] {Trace} [Enter]** - updates cue 5, and tracks changes backward until a move instruction is encountered. If the system is in track mode, the change will track forward in the cue list until the next move instruction or block. If in cue only mode, this has no impact on subsequent cues.
- **[Update] {Trace} [Cue Only/Track] [Enter]** - updates the selected cue and tracks changes backward until a move instruction is encountered. If the system is in track mode, the change is prohibited from tracking forward in the list. If in cue only mode, the change is allowed to track forward.

When a channel that is inactive (at zero or null) in the cue list receives an active level, if update trace is used, that channel will not trace the current setting into previous cues. To force that channel's new value to go backward in the cue list, **{Trace} {Trace}** can be entered.

Updating the Current Cue

The current cue is updated by simply pressing **[Update] [Enter]**. When only one cue list is active, this update will include any changes to all channels.

Updating a Source Cue

To update the source of a level in the current cue (therefore, a move instruction in a prior cue) you must specify a trace for the desired channel(s).

- **[5] [Update] [Trace] [Enter]** - updates any manual changes for channel 5 in the current cue. Any tracked values for channel 5 are traced back to the source of the value (the original move instruction) and changed to the new value. The value for traced changes in the current cue will be magenta indicating it is a tracked value.
- **[Trace] [Trace]** - If a channel was inactive in the cue (either because it had not previously been used in the cue list, or it was a tracked zero) and is set to a new level, by default the new level will not track back. You can force it by pressing **[Trace]** twice.

Updating a Non-Active Cue

It is possible to use the same update commands illustrated above to update inactive cues (cues not live onstage). In these situations, if the updated cue is not the source of a channel's live value, manual data will remain manual. If the updated cue *is* the source of the current value, the values will change to magenta (indicating tracked) when the update is completed.

Update [Thru]

Using **[Update] [Thru]** allows you to update from a current cue to a destination cue without first entering the current cue's number.

For Example:

If you are currently in cue 5 and you want to update through cue 10, you would use the following syntax:

- **[Update] [Thru] <Cue> [10] <CueOnly/Track> [Enter]**

Update [+]

[+] can be used to specify a range of cues for updating. [+] can also be used with [Record] and [Record Only].



Note: *If no cue number is entered before the [+], the current active cue will be used.*

For Example:

To update only cues 5, 10, and 15:

- **[Update] <Cue> [5] [+] <Cue> [1][0] [+] <Cue> [1][5] <CueOnly/Track> [Enter]**

To update the current cue and cue 7:

- **[Update] [+] <Cue>[7] <CueOnly/Track> [Enter]**

Recording and Editing Cues from Blind

Press **[Blind]** and the selected cue will be displayed. You can make changes to cues in the blind display using either the summary, table, or spreadsheet views.



Note: *Edits in blind take effect immediately. **[Record]** or **[Update]** commands are not required in blind.*

If changes are made in the blind display to an active cue, these changes will not impact the current stage state. To make blind changes active you can press **[Assert]** & **{Load}** button for the fader associated with the cue.

Move instructions can be removed from a cue by selecting the channel and pressing **[At]** **[Enter]**. This allows all values from the previous cue to track into the current cue. You can also use this command for specific parameters as well.

For Example:

Suppose you are in blind cue 5 and you make changes to channels 1-5:

- **[1] [Thru] [5] [At] [5] <0> [Iris] [3] [5] [Enter]**

Intensity goes to 50% and Iris to 35%. You decide to remove the Iris instruction:

- **[Iris] [At] [Enter]**

The Iris value from the previous cue tracks in. Then you remove the intensity change as well:

- **{Intensity} [At] [Enter]**

All values from the previous cue track in.

Instead of using multiple commands, you can, in one command, return the channels to their values from the previous cue:

- **[1] [Thru] [5] [At] [Enter]**

The impact of blind edits on subsequent cues is determined by the default setting of Track/Cue Only mode. Obviously in track mode any changes will track forward until the next move instruction, unless **[Cue only]** is pressed. In cue only mode any changes will apply only to the selected cue. If you want values to track forward, the **[Track]** button will allow it. The track/cue only instruction must be applied when a value is entered. **[Trace]** can also be used to have changes trace back to the initial move instruction. Such as:

- **[1] [Thru] [5] [At] [5] <0> [Cue Only/Track] [Enter]**
- **{Intensity} [Cue Only/Track] [At] [Enter]**
- **[1] [Thru] [5] [At] [5] <0> [Cue Only/Track] [Trace] [Enter]**

To Live From Blind

From blind, a softkey **{Live}** is posted when you press **[Recall From]** or **[Copy To]** to allow you to copy to or recall information from live. The following examples only work with the **{Live}** softkey, not the **[Live]** hard key.

- **[1] [Recall From] {Live} [Enter]**
- **[2] [Copy To] {Live} [Enter]**

From Summary or Table Views

Use the **[Format]** key to cycle through the available views (see [Using \[Format\], page 39](#)).

Summary view allows you to see the greatest number of channels at once, though parameter data is somewhat truncated. Channels with focus, color, or beam data are indicated with a respective F, C, or B beneath the level data. This view is useful for viewing lots of channel data at once or for editing primarily intensity values.

Table view grants you greater visibility of parameter data and a reduced number of visible channels. This view displays channels along the y axis and parameters along the x axis. Parameter categories are always visible (I, F, C, and B). You can also view specific parameters by pressing and holding the **[Data]** button and then pressing the category softkey(s) for the parameters you wish to view. This will expand the category to show any parameters used in the show. You can also deselect the parameters you do not wish to see. This is remembered the next time you go to table view.

The table view is useful for viewing and editing all parameters for a smaller number of channels.

Both summary and table views allow you to make changes to channels or parameters.

From the Cue Spreadsheet

The cue spreadsheet is another useful blind view of cue data. In spreadsheet view, cues are listed on the y axis and channels and parameters are displayed on the x axis. This view is useful for viewing a limited number of channels over a span of numerous cues. This makes spreadsheet view useful for viewing overall trends in channel and parameter data. Pressing **[Data] + {parameter tiles}** will expand or collapse information shown.

Editing cue ranges is possible in spreadsheet view. **{Move To}** is only available from this view. To select an entire cue range, you can press **[Cue] [enter the first cue] [Thru] [Enter]**.

Replace With

{Replace With} is used to select channels that have certain specified values and then provide new instructions for those values.

For Example:

Select a range of cues:

- **[Cue] [1] [Thru] [9] [Enter]**

Select a range of channels that are used throughout these cues and enter a change instruction:

- **[1] [Thru] [7] <At> [Color Palette] [5] {Replace With} <Color Palette> [3] [Enter]**

This instruction finds all instances of channels 1-7 in cues 1-9 that are in color palette 5 and replace CP5 with CP3. Be aware of the track/cue only settings when using this command.

The range of possibilities of potential **{Replace With}** commands is virtually endless and can be applied to single cues or channels, ranges of cues or channels, parameters of any type, or timing data.

Move To

{Move To} is used to move cues from one location in a cue list to another location in the same or a different cue list. When cues are moved, values that were tracks or move instructions and *now* match the previous cue will be auto-blocked by the system. The impact on subsequent cues is based on track/cue only settings as described above. Below is an example of **{Move To}**:

- **[Cue] [2] {Move To} <Cue> [9] [Enter]** - the contents of cue 2 moves to cue 9. Cue 2 is deleted. If cue 9 already existed, a confirmation would be required to overwrite it. You can also hit **[Copy To] [Copy To]** to access **{Move To}**.

In the above example, any tracked values in cue 2 become blocks (see [Block, page 176](#)) or moves in cue 9, as well as any move instructions which now match the previous cue. Cues after cue 9 are affected based on the default setting of track/cue only. Any values in the cue after cue 2 that tracked from moves in cue 2 are changed to move instructions.

Ranges of cues can be moved as well. You can also move cues to other cue lists. In either of these situations if any cue is to be overwritten, a confirmation is required.

Using Encoders in Blind

The encoders are disabled by default in blind. Press an **[encoder paging key]** prior to moving the encoders, and they will function while you remain in blind.

When a cue is specified, you can select channels and alter parameters using the encoders. **[Cue Only/Track]** can be placed on the command line to determine how these changes will impact subsequent cues.

Deleting Cues

Cues, lists of cues, or ranges of cues can be deleted. When deleting cues, the track/cue only setting of the console will determine how subsequent cues are affected. The **[Cue Only/Track]** button can be used to modify the default behavior as needed.

In Track Mode

When the console is in track mode, deleting a cue also removes any move instructions provided by the cue. For example, assume you have stored cues 1-10 and cue 5 contains move instructions for channels 1-5. If cue 5 is deleted, the move instructions are deleted as well and the values from cue 4 will track directly into cue 6 and beyond.

In this instance, if you used the **[Cue Only]** button in the delete instruction, cue 5 would be deleted, but the tracked values in cue 6 that originated in cue 5 would remain and be converted to move instructions.

In Cue Only Mode

When the console is in cue only mode, any subsequent tracked values are not eliminated, but are converted to move instructions instead.

In the example above, deleting cue 5 (in cue only mode) would result in any tracked values in cue 6, that originated in cue 5, being converted to move instructions.

If you apply the **[Track]** button to the delete instruction, the move instructions from cue 5 are deleted and the values from cue 4 would then track into cue 6 and beyond.

Some examples of cue deletion are:

- **[Delete] <Cue> [5] [Enter] [Enter]** - deletes cue 5. Subsequent cues in the list are affected depending on the console default setting as described above.
- **[Delete] <Cue> [6] [Cue Only/Track] [Enter] [Enter]** - deletes cue 6, making exception to the default setting, as described above.
- **[Delete] <Cue> [7] [Part] [1] [Enter] [Enter]** - deletes part 1 of cue 7.
- **[Delete] <Cue> [8] [Part] [1] [Thru] [3] [Cue Only/Track] [Enter] [Enter]** - deletes parts 1-3 of cue 8, making exception to the default setting, as described above.
- **[Group] [1] [Delete] <Cue> [2] [Enter]** - deletes any channels in group 1 from cue 2. Cue 2 remains in the cue list and any channels not in group 1 are unaffected.
- **[Delete] <Cue> [2] [Thru] [8] [Cue Only/Track] [Enter] [Enter]** - deletes cues 2-8, making exception to the default setting, as described above.

www.carlosmendoza.com.mx

Chapter 12

Using Mark

{Mark} is an instruction that automates the process of presetting moving lights to their required state in a cue, prior to fading intensity up. This allows your moving lights to unobtrusively perform non-intensity parameter transitions in an inactive (darkened) state.

Ion provides two different methods to mark lights: AutoMark and Referenced Marks.

This chapter contains the following sections:

- **AutoMark**192
- **Referenced Marks**193

AutoMark

The AutoMark feature is a system default setting and can be turned on or off at a global level. The system default for this setting is off. To change the default settings see [Show Settings, page 96](#).

When AutoMark is enabled, non-intensity parameter transitions will occur in the cue *immediately preceding* the cue in which the changes are stored, if intensity in that cue is moved from zero to any active level. Therefore, the preceding cue “executes” the AutoMark.

AutoMark information is displayed for cues or cue parts. It is not a channel instruction. AutoMarked cues are indicated by an “M” in the M column of the playback status display.

AutoMarks will execute using the time of the cue in which the moves occur (the cue indicated by “M”). The exceptions to this are the mark time in setup, or if discrete timing is stored with the move instruction, in which case the discrete time will be used.

AutoMarks will display the same way in live and in blind.

Conditions Triggering an AutoMark

The following rules determine which channels AutoMark is applied to and how it is deployed:

- The marked cue must have a move instruction for intensity of moving lights above zero or null.
- The marked cue must have a move instruction for non-intensity parameters of those channels.
- AutoMark will not occur if the channel is receiving an intensity instruction from another source (such as a submaster or HTP fader).
- AutoMark must be enabled for an AutoMark to occur. AutoMark is based on the current setting of the default *during playback*. It does not matter what the setting is at the point of record.
- On a “per channel” basis, an AutoMark does not occur until:
 - Any parameter delay time has elapsed *and*
 - The intensity has reached zero and the parameter has completed any previous movement.

Allowing a Live Move

When AutoMark is “On” it is possible to override it on a per cue (or cue part) basis. The override will be available through a softkey, “AutoMark Off”. This softkey is not visible when AutoMark is disabled in default settings.

AutoMark can be disabled on cues or cue parts.

When enabled, the cue that executes the mark will have an “M” in the flags field. If AutoMark is disabled, allowing a live move, a “D” is displayed in the flags field of the cue or cue part where the data is stored.

By using AutoMark with multipart cues, it is possible to have some parameters mark and others move live.

AutoMark and Timing

An AutoMark will happen in the time of the cue in which is moving (the “M” cue), unless the channel has discrete timing or the mark time has been changed in setup. Discrete timing would override the mark time option in setup. [See “Mark Time” on page 197](#). In which case, the discrete timing will apply to the moves. Discrete timing is applied in the cue where the move instruction is stored.

Referenced Marks

Referenced marks are user-specified marks that are manually applied to specific channels or parameters. When AutoMarks are disabled, referenced marks may be used. AutoMark and Referenced Marks cannot be used simultaneously.



Note: *If you begin programming with AutoMark enabled, and then disable the feature, all of the AutoMarks in the show are converted to referenced marks.*

There are essentially two parts to a successful referenced mark. The first part is the cue with the mark flag (set by the user). This is the cue in which any non-intensity parameters will change. This cue is referred to as the **marked cue**.

The second part is the cue with intensity value for the channels in question. This is referred to as the **source cue**. This is also the cue where the non-intensity moves are stored.

In order to use mark properly, you *must specify* channels to be marked in the source cue. Ion will not assume all moving lights apply to any given mark.

There are two ways to apply a referenced mark. You can apply a mark flag at a cue level and then subsequently reference that flag in a later cue, **or** you can apply a mark in a cue and reference back to an earlier cue.

Referenced marks are useful because the non-intensity parameter data is stored in the cue that actually fades the lights up. Therefore, any changes to the non-intensity parameter data is modified in the source cue. You do not need to worry about changing it in the marked cue.



Note: *When bringing up the intensity of a fixture that is in a marked state, all the parameters of that fixture will be made manual and the current NPs settings will display. This is done so you won't need to use **{Make Manual}** when storing to a cue.*

Setting Referenced Mark Flags

You can apply a mark flag by pressing:

- **[Cue] [n] {Mark} [Enter]**

This sets a flag (M) on a cue for later marking activity. In subsequent cues, when channels are marked, they will preset for movement in this cue (unless told to mark elsewhere).

When you are building a cue containing channels that you want to mark, do the following:

- **[select channels] {Mark} [Enter]**
- Store the cue, following normal procedures. Ion will automatically look backwards in the cue list for the first mark flag it encounters.

For Example:

Assume you had placed a mark flag on Cue 10 (this becomes the Marked Cue).

- **[Cue] [10] {Mark} [Enter]**

Later you store Cue 12 with a mark instruction on channels 1-10 (this becomes the Source Cue).

- **[1] [Thru] [10] {Mark} [Enter]** - Note that channels 1-10 are displayed with a red "M" in the upper right corner.
- **[Record] <Cue> [1] [2] [Enter]**

Since no specific mark instruction was given to the channels in cue 12, the channels will

mark back to the first “M” encountered in the preceding cues of the cue list, provided that the intensity for those channels is “out” throughout the duration of the mark.

When Cue 10 is played back, the non-intensity parameters of channels 1-10 will fade to the values stored in Cue 12. Then in Cue 12, the intensity will fade up on those channels.

Mark Display Indicators

In the previous example, indications that a mark had been placed are as follows. Cue 10 would be shown with a mark flag (M) in the cue list. In addition, when cue 10 is played back, channels 1-10 will show a green “MK” in the intensity field, while the non-intensity parameters would show the source cue number in green “Q12” (the MK in the intensity field is green if, in cue 10, the lights are fading to zero and then the NPs are marking. If, in cue 10, channels 1-10 were already at zero, a magenta “MK” will be displayed).

The source cue (cue 12) would include a green “M” next to the intensity level and any non-intensity parameter values would be displayed in green. Also, in the cue list, cue 12 would have an “R” in the mark flags field. If a mark has been placed on a cue, but that cue is not yet marking any lights, the “M” will be represented as “m”. You will also see an “m” if the mark is no longer in tact.

Applying Flags as Channels are Marked

You may also apply a mark flag to a previous cue by doing the following:

- [select channels] {Mark} [Cue] [5] [Enter]
- [Record] [Cue] [8] [Enter]

This would mark cue 5 to perform any non-intensity moves stored in cue 8. The display indicators for this mark would be the same as shown in the previous example. As long as intensity is at zero within the cue range, if there are any non-intensity move instructions for these channels between these two cues, they will be removed.

It is also possible to mark only certain parameters for marked moves, while allowing live moves for other parameters.

For Example:

If you wanted to mark only focus, and allow all other parameters to transition while the light is fading up, you can press:

- [1] [Thru] [10] [Focus] {Mark} [Enter]

Removing Referenced Marks

Mark is a toggle state. Therefore, the first mark command sets a mark. The second removes it.

To remove a mark flag from a cue, press:

- [Cue] [n] {Mark} [Enter]

To remove a mark from a channel:

- [select channel] {Mark} [Enter]



Note:

If a mark is removed from a channel in live, the corresponding cue must be updated.

It is also possible to mark to a cue that doesn't exist, and when the mark is stored, Ion will automatically create the cue to mark to.

For Example:

If cue 2 does not exist yet:

- **[select channels] {Mark} [2] [Enter]**

The command line will display, "Create Mark Cue?"

- **[Enter]**

When the cue is stored, the system will automatically create a cue 2 and mark the lights to it.

If a light is marked and that mark is later broken (for example being used by a move instruction stored in the mark range), Ion will attempt to repair the mark. This is done by automarking in the cue previous to intensity fading up, if possible. This will be indicated in the cue list by a "*" in the cue immediately preceding the "R" cue.

Mark Earliest

The **{Earliest}** command can be used with **{Mark}** to mark the channel into the cue after the last intensity moved from a nonzero level to 0. The mark is stored and behaves exactly as if you had typed the cue number instead of **{Earliest}**. This works in blind, or in live if you record afterwards.

For Example:

Cue 2 moves the intensity for channel 1 to 0, Cue 3 thru 4 have no intensity for channel 1, and Cue 5 has the intensity move to full. From Cue 5:

- **[1] {Mark} {Earliest} [Enter]**

This will work the same as **[1] {Mark} [Cue] [3] [Enter]**, and will mark from cue 3 to cue 5.



Note:

[Mark] {Earliest} will mark through block cues or blocked intensity moves of 0, until it finds the earliest intensity move to 0. If the cue immediately before the cue being marked is the earliest intensity move to 0, it will mark in that cue.

{Earliest M} will mark to the earliest cue that already has a mark flag. If a mark cue doesn't exist, **{Earliest M}** will behave like **{Earliest}** and will mark to the earliest possible cue.

Mark Symbols

The symbols that appear in the Mark flag include:

Live

- **MK** Indicates the channel is marked for a later cue. The cue number is indicated in the other categories (see “Q” below).
- **Q** Found in the non-intensity categories of a marked channel. The “Q” is followed by a number indicating which cue the mark is in preparation for.
- **M** Indicates a mark is placed, but manual, and must be stored. Is blue when stored. “m” indicates cue is not marking.

Playback Status Display

- **D** AutoMark is disabled.
- **M** or **m** Indicates a marked cue. “M” indicates an AutoMark or a reference mark that is used by a subsequent cue. “m” indicates a reference mark that is currently unused by any subsequent cue. Found in the “Flags” area.
- **R** Indicates the source cue which refers back to an earlier mark. Found in the cue display “Flags” area.
- **+** Indicates a cue is both a marking and reference cue when displayed in the mark flag.
- **-** Indicates a dark move, a cue that has any non-intensity parameters moving on channels whose intensity is at 0.
- **x** Indicates that a mark has been placed, but the mark has been broken. If possible, Ion will AutoMark the lights.

Reference Marks and Timing

Movement of non-intensity parameters in conjunction with a mark will adhere to the following timing rules.

If discrete timing is used for non-intensity parameters:

When channels execute a mark, the moves will use the discrete time(s) assigned to them *in the source cue*.

For Example:

A mark is applied to Cue 5, making it the marked cue.

- **[Cue] [5] {Mark} [Enter]**

Later, channels 1-10 are assigned discrete timing and a mark instruction:

- **[1] [Thru] [1] [0] {Focus} [Time] [8] {Mark} [Enter]**

Then, those channels are recorded into Cue 10:

- **[Record] <Cue> [1] [0] [Enter]**

In this instance, when Cue 5 is executed, channels 1-10 will perform their focus parameter moves in 8 seconds, as specified in Cue 10 (the source cue, which is the source of their move instruction).

If no discrete timing is used for non-intensity parameters or mark time is disabled:

When channels execute a mark, the moves will use the time recorded *in the marked cue*.

For Example:

Cue 5 is recorded with a time of 10 seconds.

- **[Record] <Cue> [5] [Time] [1] [0] [Enter]**

A mark is applied to Cue 5 as above.

- **[Cue] [5] {Mark} [Enter]**

Later, channels 1-10 are assigned a mark instruction and then recorded into Cue 10 with *no* discrete timing:

- **[1] [Thru] [1] [0] {Mark} [Enter]**
- **[Record] <Cue> [1] [0] [Enter]**

When Cue 5 is executed, channels 1-10 will perform their non-intensity parameter changes in 10 seconds, as specified in Cue 5 (the marked cue).

Marked cues that are played out of sequence will fade to their marks immediately. When firing a cue that has a linked cue, the cue will mark like the linked cue is the next cue. The marks will fade using the active cue's timing.

Mark Time

Mark time is a setup option (**Setup > Show > Show Settings > Mark Time**) which allows you to set the time that mark instructions will use. When **{Mark Time}** is disabled, which is the default, mark instructions will use cue timing unless overridden with discrete timing. When you enter a mark time in setup, all NPs that mark (either through referenced marking or AutoMark) will use this time. The only way to override setup mark time is to use discrete timing. Clearing the **{Mark Time}** field sets it back to disabled. Select **{Mark Time}** and hit **[Enter]** to disable the default mark time

www.carlosmendoza.com.mx

Chapter 13

Using Filters

Filters are used to determine which parameters can be stored to cues, palettes, and presets. The filter selection tool in the CIA affects record operations as long as the filters are set.

This chapter contains the following sections:

- **Record Filters**200
- **Storing Data with Record Filters**201

Record Filters

Record filters are used to select specific parameter data to store to record targets. When no filters are selected, all parameters can be stored, as appropriate to the **[Record]**, **[Record Only]** and selective record action used.



Note:

When storing show data, applied filters are highlighted and allow the associated parameters to be stored in record targets.

When filters are deselected (not highlighted), they prohibit storing the associated parameters.

There is no difference between having all filters selected and having no filters selected (default). In either state, all parameters are available for recording.

Record filters are applied from the CIA using the following buttons:

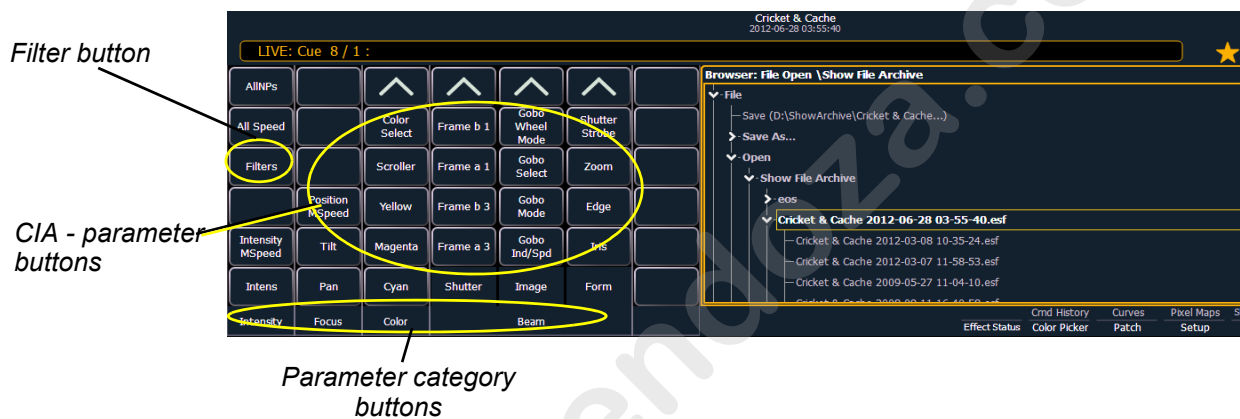

The parameter category buttons can be used to select filters, as follows:

- Intensity (enables recording intensity data)
- Focus (enables recording pan and tilt)
- Color (enables recording color data)
- Beam (enables recording all beam data)

To apply record filters by category:

- Step 1: Click **{Filters}** in the top-right corner of the parameter grid in the CIA. The parameter buttons change to display filter selection.
- Step 2: Click the parameter category button **{Intensity/Focus/Color/Beam}** for the category you want to include in the record target. All parameters in that category will be highlighted and “Filter On” will appear above the softkey.
- Step 3: Click **{Filters}**. The buttons return to their normal appearance.

In subsequent record functions, only the filtered categories will be recorded. You may apply multiple category filters at once. Remember that applying all filters and no filters yields the same effect.

Partial Filters

If you do not want an entire category to be recorded, you may apply parameter specific filters (partial filters) instead.

To apply partial filters:

- Step 1: Click **{Filters}** in the top-right corner of the parameter grid in the CIA. The parameter buttons change to display filter selection.
- Step 2: Click the parameter button (for example **{Zoom}**) for the parameter you want to include in the record target. That parameter will be highlighted and “Filter On” will appear above the softkey.
- Step 3: Click **{Filters}**. The buttons return to their normal appearance.

In subsequent record functions, only the filtered parameters will be recorded. You may apply as many partial filters at once, as you wish. Any *unfiltered* parameters will not be included in record actions. In live, unfiltered parameter data is displayed in its proper color, but a grey “n” (indicating null data) will appear in the upper right corner of the parameter’s field.

Removing Filters

Applying filters is a toggle state. To remove any filter, simply repeat the application process described above. When pressed again, any applied filter will be removed.

To remove all filters at once:

- Step 1: Press and hold **[Filters]**. The parameter buttons change to display filter selection. **{Clear Filters}** appears in the upper left corner of the parameter buttons.
- Step 2: Press **{Clear Filters}**. Any applied filters will be removed and the highlights will turn off.
- Step 3: Release **[Filters]**. The buttons return to their normal appearance. All parameters are now available to record functions.

Storing Data with Record Filters

If a record target is stored with filters in place, the filters allow only associated parameter data to be recorded in the target. Non-filtered data is not included when you record.

The various record targets are affected by filters in the following ways:

- **Palettes** - Palettes by definition are already filtered. The color and beam filters can be used to further modify what is stored in the color and beam palettes, however.
- **Presets** - Active filter settings impact what is stored in presets.
- **Cues** - Active filter settings impact what is stored in cues, even when using “record only” commands.
- **[Recall From]** - Recall from instructions are not affected by the filters.

www.carlosmendoza.com.mx

Chapter 14

Working with Multiple Cue Lists

Ion provides many useful tools to allow you work efficiently and simultaneously with multiple cue lists. This chapter focuses on the features and methods used when working with more than one cue list.

This chapter contains the following sections:

- ***Recording to a New Cue List***204
- ***Using Assert***.....204
- ***Changing the Active Cue List***.....206
- ***Using [Go To Cue] with Multiple Cue Lists***207
- ***Using the Cue List Index***.....208

Recording to a New Cue List

When recording cues, cue list 1 is initially used as the default cue list. Cue list 1 is displayed with only the cue number. It does not have a lead cue list number or a “/”. To record to another cue list, that list must be specified. Cues will then be recorded to that cue list until another list is specified, or until the selected cue is changed in live.

You may record up to 999 cue lists in an Ion show file.

The cue list that you are storing to is always determined by the selected cue, unless you specify a different cue list. The selected cue is displayed just above the command line on the CIA, and at the bottom of the live/blind screen.

The selected cue is the last cue that you affected in live. This includes a record, an update or a playback action such as **[Go]**, **[Back]**, or a **[Go To Cue]** instruction, or simply changing the timing on a cue. It is very useful to keep an eye on the selected cue. Pressing **[Live]** will resync to the active cue.

Using Record

[Record] will record all parameters of any channels that have non-default values to a specified cue.

To record to a new cue list, press:

- **[Record] <Cue> [2] [/] [5] [Enter]** - this will create cue list 2 and will record the data to cue 5 in that cue list.

Any cues recorded after this will automatically record to cue list 2 until another cue list is specified or the selected cue changes the cue list number.

Using Record Only

[Record Only] can be used to create a new cue list instead of **[Record]**. **[Record Only]** stores only manual data to the specified cue.

To record to a new cue list press:

- **[Record Only] <Cue> [2] [/] [5] [Enter]** - this will create cue list 2 and will record all manual data to cue 5 in that cue list.

The cue list display will change to show only data from cue list 2. Any cues recorded after this will automatically record to cue list 2 until another cue list is specified or the selected cue changes the cue list.

Make Manual

This softkey can be used to convert live cue or submaster data into manual values, allowing them to be included in the **[Record Only]** operation. Therefore data from other cues or lists can be selectively converted to manual data and then stored to another cue/list using **[Record Only]**.

For more information on **{Make Manual}**, see [Using {Make Manual}, page 231](#).

Using Assert

By default, channel parameters only respond to move instructions during playback (see [Cue List Ownership, page 6](#)). The **[Assert]** function allows tracked or blocked data from a cue to be replayed, even when another cue list has taken control of that channel or parameter.

Assert can be applied to cues, cue parts, channels, channel parameters, or to entire cue lists.

Asserted channels will play back their tracked and blocked values, regardless of cue list ownership, when the associated cue is replayed.

At a Cue Level

When applied at a cue level, **[Assert]** ensures that *all* data in the cue - both moves and tracks - will be played back at their stored values.

To place an assert on a cue press:

- **[Cue] [x] [/] [y] [Assert] [Enter]** - the cue will assert all of its channels upon playback. An "A" will be displayed in the "A" column of the cue attributes (cue index, playback status, and so on); indicating the cue has been asserted.

Assert can also be used from the command line to manually replay portions of a cue without having to replay the entire cue. Assert in this mode can only be used with cues that are currently active.

To place an assert on a portion of a cue:

- **[Group] [6] [Assert] [Cue] [4] [Enter]** - asserts the instructions for the channels in group 6 in cue 4.

This would then need to be stored using either **[Record]** or **[Update]**.

At a Cue List Level

When applied at the cue list level, **[Assert]** ensures that all values in all cues in that list are asserted on playback. When a cue list has been asserted, the playback status display will show an 'A' in the assert column for every cue in that list.

To place an assert on a cue list:

- **[Cue] [x] [/] {Assert} [Enter]**

At a Channel Level

When applied at a channel or parameter level, assert ensures that the entire channel or the specified parameter will be played back at its stored value.

To place an assert on a channel or group of channels:

- Step 1: **[select channels] [Assert] [Enter]** - a red "A" will appear next to all of the channels' parameters in the live/blind display. This indicates the assert is placed, but not yet recorded to a cue.
- Step 2: **[Record] <Cue> [x] [Enter]** - the red "A" turns to blue in the live/blind display, indicating the assert has been recorded. In the cue x row of the playback status display or the cue list index, a lower case 'a' appears in the "A" column, indicating that a partial assert is included in cue x.

You may also store this assert using **[Update]** or you can apply it in blind.

To place an assert on specific parameters:

- Step 1: **[select channels] {Intensity/Color/Focus/Beam or parameter buttons} [Assert] [Enter]** - places an assert on the specific parameters of the selected channels.
- Step 2: **[Record] <Cue> [x] [Enter]** - the assert is recorded to cue x. In the cue x row of the playback status display or cue list index, a lower case "a" appears in the "A" column, indicating that a partial assert is included in cue x.

Assert is a very useful tool allowing channels that have been seized by other cue lists to be repossessed by the associated cue list, while still allowing the asserted channel data to be treated as tracked instructions.

Using AllFade

Allfade is a cue attribute that commands any intensity values on stage that are not provided by the associated cue to fade to zero intensity when the cue is played. The allfade will adhere to the downfade time of the associated cue.

This is useful in conjunction with assert, so you can regain control of channels from other cue lists and fade other channels from that cue list out.



Note: *Channels with tracked values in the associated cue will not fade out in response to an allfade. These tracked values are part of the associated cue and therefore will be played back.*

To assign an allfade to a cue:

- **[Record] <Cue> [n] [/] [m] [Allfade] [Enter]** - records cue n/m as an allfade cue, thereby forcing any channels not in the cue to fade to zero on playback.

Like many other cue attributes, allfade is a toggle state. To remove the allfade flag, specify the cue and press **[Allfade] [Enter]**.

Changing the Active Cue List

The active cue list will be displayed in detail on the playback status display. This view is changed by the following actions:

- Recalling another cue list in the command line - **[Cue] [3] [/] [Enter]**
- Recording a cue to another cue list - **[Record] <Cue> [3] [/] [8] [Enter]**
- Playing back a cue from the fader of another cue list - press **[Go]** for the associated fader.



Note: *The split Playback Status Display allows detail for two cue lists. Both or either of these can be locked. See “Split Playback Status Display” on page 43.*



Note: *For information on using out of sequence sync, see [Using External Links](#), page 178.*

Using [Go To Cue] with Multiple Cue Lists

[Go To Cue] defaults to the currently selected cue list. [Go to Cue] is a live function. It can not be used to change cues in blind. [Go to Cue] instructions can be executed from any operating mode, without returning to live.

By default, a Go to Cue instruction is an out-of-sequence cue and will follow the rules of such (see [Out-of-Sequence Cues, page 218](#)).

For examples of how to use [Go To Cue] in playback, please see [Go To Cue, page 218](#).

Using Go To Cue 0

[Go To Cue] [0] is a command line instruction that resets all intensity values not owned by another fader to default, including any manual values that are not an override to another active fader value.

[Go To Cue] [0] [Enter] also resets the selected cue list to the top of the list, with the first cue pending.

To [Go To Cue] [0] on another cue list, press:

- [Go To Cue] [2] [/] [0] [Enter]



Note:

Ion has an added intensity parameter for LED fixtures, that by manufacturer default, have only RGB parameters but no intensity parameter. With this added control, the LED fixture will respond to the [Go To Cue] [0] command.

Captured channels, independent values and values from other faders running a different cue list are not affected by a [Go To Cue] [0] command.

When [Go To Cue] [0] is executed, any intensity values owned by the associated cue will fade out, while all non-intensity parameters remain in the current state. A [Go To Cue] [0] instruction does not impact the input from other programmers using partitioned control, unless the channels or parameters are shared.

[Go To Cue] [0] & [Load]

You can use [Go To Cue] [0] in conjunction with a fader load button to send a specific cue list to cue 0. This action does not use the command line. On the desired fader, simply press:

- [Go To Cue] [0] & [Load]

Using Go To Cue Out

To reset all parameters to their default state (unless they are controlled by a submaster) and reset all cue lists that are loaded to faders so that the first cue of each list is pending, press:

- [Go To Cue] [Out] [Enter]

Using the Cue List Index

The cue list index is a blind display list which shows the cue list you are working with, the cue status, any other stored cue lists and what (if any) faders the lists are loaded onto. All cue attributes can be edited from the list including whether the cue list is set to independent or not, and if the intensity values in the cue list will play back as HTP or LTP. Cue attributes can be changed in live or blind, but independent, background, and HTP/LTP settings can only be set in the cue list index.

Open the Cue List Index

You can access the cue list index by pressing **[Cue] [Cue]**, or you can navigate within the browser to **Record Target Lists > Cue List Index** and press **[Select]**.

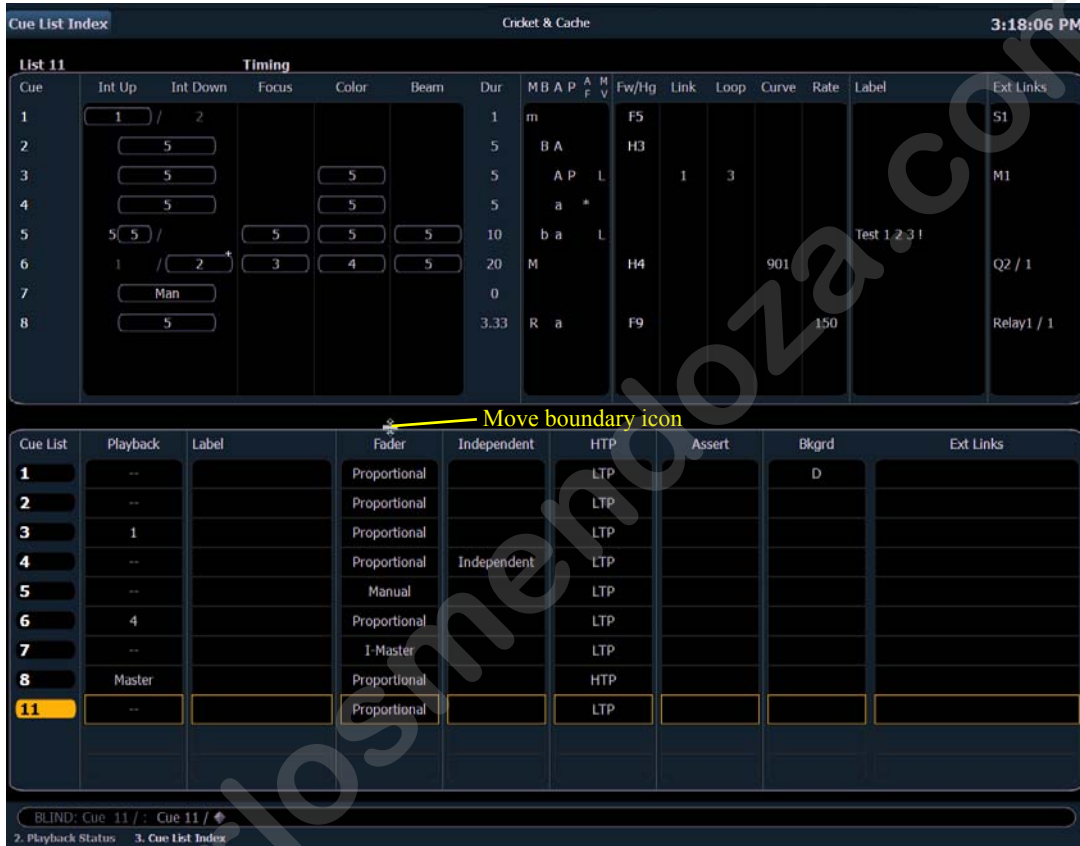

The top half of the cue list index displays all stored cues, including cue attributes, for the selected cue list. The bottom half of the cue list index displays all stored cue lists. The selected cue list is highlighted.

Using the mouse, you can move the barrier between the stored cue display (top) and the stored list display (bottom) to increase or decrease the viewing area of either section. Hover the mouse arrow over the list boundary until it changes to the familiar "move boundary" icon. Then click and drag the boundary up or down to the desired height.

Cue List Attributes

Cue list attributes determine how the cue list will interact with other playbacks. Cue list attributes include:

- The cue list number
- The cue list label
- Fader type (Proportional, Manual Master, or Intensity Master)
- Independent (default is not enabled)
- Intensity HTP or LTP setting (default is LTP)
- Assert
- Background
- External Links

When a cue list is loaded to a fader, all attributes of that cue list are in effect. When a new cue list is loaded, the attributes of that cue list are in effect, and any manually set behavior of the fader (such as filter states, timing disable, etc.) are maintained.

When the cue list index is in focus, the following softkeys are available for editing the cue list: **{HTP/LTP}**, **{Independent}**, **{Solo Mode}**, **{Fader}**, **{Edit}**, **{Background}**, and **{Execute}**.

HTP/LTP

The **{HTP/LTP}** softkey is a toggle state between LTP (latest takes precedence) and HTP (highest takes precedence). For more information on HTP/LTP see [HTP vs. LTP, page 7](#).

All parameters other than intensity are LTP.

Intensity, by default, is also LTP. Cue lists can be set with an HTP intensity override. When a cue list is set to HTP, intensity values provided by that cue list will override the LTP value (of which there can be only one), provided the HTP instruction is higher than the LTP value. When a cue from an HTP cue list is executed, Ion determines if the intensity value when the cue is complete will be higher than the current setting. If so, the intensity will begin to fade from its current value to the required value in the incoming cue using the cue's upfade time.

Note that this behavior is relevant only to cues. If a submaster is going to provide a higher level, Ion will wait until the value is matched before assuming control of the intensity.

The following example illustrates the use of the **{HTP/LTP}** softkey in the cue list index:

- **<Cue> [1] [/] {LTP/HTP} [Enter]** - toggles the selected cue list between HTP/LTP behavior.

Independent

The **{Independent}** softkey sets a cue list to independent. Any channel parameters currently under the control of an independent playback cannot be changed by other non-independent playbacks or submasters. Independent status is equally shared between other independent cue lists and submasters.

The following example illustrates the use of the **{Independent}** softkey in the cue list index:

- **<Cue> [2] [/] {Independent} [Enter]** - toggles the selected cue list between non-independent and independent mode.

Solo Mode

The **{Solo Mode}** softkey is useful in multiple programmer situations. **{Solo Mode}** is used to pull a cue list out after it has been synced with other lists for editing purposes.

For Example:

Cue List 1 is being used by one programmer and Cue List 2 was programmed by a second programmer. For the run of the show, the lists are synced so they run together. But if changes need to be made to Cue List 2 and not be affected by the playback of Cue List 1, **{Solo Mode}** can be used.

- **[Cue] [2] [⏏] {Solo Mode} [Enter]** - places Cue List 2 into solo mode.

{Solo Mode} is a toggle state. So if Cue List 2 is already in solo mode, and **[Cue] [2] [⏏] {Solo Mode} [Enter]** is used again, that list will no longer be in solo mode.

Fader type

Faders can be set as Proportional, Manual Master, or Intensity Master (I-Master). This affects how cues are recalled and modified. [See “Proportional vs. Intensity Master” on page 259.](#) [See “Manual Master Cue Lists” on page 226.](#)

Proportional faders, when the slider is set to zero prior to the execution of a cue, will withhold playback of intensity data until the slider is raised. Intensity data will then be played back proportionally according to the level of the fader. Once the slider reaches full, the cue is considered complete and the cue is released from the manual fader. If the slider is at any value other than zero when the cue is executed, intensity values will play back normally. If the slider is returned toward zero, intensity in the cue will face to the previous level.

Faders set as Intensity Masters will master the intensity level for cues during playback. Therefore, intensity masters set below 100% will proportionally limit playback of intensity data relative to the level that the slider is set. All non-intensity parameters are unaffected by the slider. Once the slider has reached full, control of intensity is retained. If the slider is moved toward zero, intensity will proportionally fade toward zero (not the previous state as per proportional faders).

For Example:

The playback fader for cue list 1 is an intensity master and the slider is set at 50%.

When a cue is played back on this fader, intensity values will raise to 50% of their final values and then stop. As the intensity master is raised/lowered, intensities will increase/decrease accordingly. Once the slider has reached full, control of intensity is retained.

Background

The **{Background}** softkey is a toggle state for enabling/disabling the background state of a cue list. Background states are enabled by default. When enabled, the content of the cue list will act as a background or previous state for other cues and submasters. When a cue list has its background state disabled, a “D” will display in the Cue List Index background column.

Edit

The **{Edit}** softkey opens a blind channel view of the selected cue and changes focus from the cue list index. You can change the blind display to spreadsheet or table view by pressing the **[Format]** key. You can edit any of the cue attributes for the cue selected in the index, but the cue contents must be edited in the blind display. [See “Recording and Editing Cues from Blind” on page 186.](#)

Chapter 15

Multipart Cues

Cues can be divided into up to 20 parts. This chapter describes the methods used to create and edit multipart cues.

This chapter contains the following sections:

- **About Multipart Cues** 212
- **Record a Multipart Cue in Live** 212
- **Storing a Multipart Cue in Blind** 214

About Multipart Cues

Cues can be divided into up to 20 parts. Each part can have its own channels or parameters, levels and timing information. Multipart cues can be stored in live or blind using the same conventions to record a standard cue.

There are three basic ways to create a multipart cue. You can build a multipart cue part-by-part in live, you can break an existing cue into multipart cues in live, or you can break an existing cue apart in blind.

A channel or parameter can only be provided an instruction once in a multipart cue. For example, it isn't possible to adjust color for channel 1 in Cue 1 Part 1 and then also provide a different instruction for channel 1 color in Cue 1 Part 8.

Default part timing is drawn from the cue level timing defaults established in **Setup**; you may also assign discrete timing to channels in each part as you would for a single part cue.

Record a Multipart Cue in Live

Storing a multipart cue in live is accomplished in similar fashion to storing a single part cue. However, rather than storing the entire cue, you select and store just the channels that you want in each part.

Please note that there are a variety of different ways and different orders to go about creating a multipart cue. The following examples represent some, but not all, of those ways.

Creating a New Multipart Cue in Live

Build part-by-part

Make desired changes to the stage state. If all of the changes that you have made are to go into a part, press:

- **[Record Only] [Cue] [2] [Part] [1] [Enter]**

Continue making changes and storing parts as you go.

Build parts from cue end state

In most instances, you will create the end state of the cue and then break it into parts. To do this, you use selective storing commands, as follows:

- **[channel or parameter selection] [Record] (or [Record Only]) [n] [Part] [a] [Enter]**
- **[channel or parameter selection] [Record] (or [Record Only]) [Part] [b] [Enter]**

Each part can contain its own cue level timing and other attributes. Follow/Hang, Link and Loop, and Allfade commands can be placed at the cue level only—they cannot be placed on a part. Also, through the channel selection, you can put channel parameters into different parts.

Part 1 of any multipart cue is where all unassigned move instructions will reside. Therefore, if the body of the cue (which is the normal behavior) is to be in part 1, you can simply select the channel or parameter list that you wish to place in parts 2 and higher.

Setting Multipart Cue Attributes

Cue attributes, such as **[Time]**, **[Delay]**, **[Block]**, **[Assert]**, **[Label]**, **[Rate]**, **[Mark]**, and **{AutoMark Off}** can be assigned in part cues. They are stored and function exactly as they do in single part cues.

Cue part attributes can be defined as the parts are recorded, or they can be added after the part has been created. For example:

- **[Record] [Cue] [2] [Part] [1] [Delay] [8] [Enter]**
- **[Cue] [4] [Part] [3] {Color} [Time] [6] [Enter]**
- **[Cue] [8] [Part] [9] {AutoMark Off} [Enter]**
- **[Record Only] [Cue] [5] [Part] [2] [Assert] [Enter]**

For more on cue attributes, see [Assigning Cue Attributes, page 173](#).

Using Update in Live

Updating a multipart cue is generally the same process as updating a single part cue, except you will provide a specific part cue number in the update command.

Various referenced data, such as palettes or presets, can be assigned to build a multipart cue. If you have made changes to referenced data within a multipart cue, thereby creating manual data, pressing **[Update] [Enter]** updates both the multipart cue and any referenced data with the new levels, as it does with single part cues.

You can update a part of a multipart cue with only selected parameters as well.

For Example:

Assume you have written cue 1, which is a multipart cue and is active. Part 2 includes channels 1 through 5 referencing intensity palette 2 which is set at 25%. Select channels 1 through 5 and change the intensity value to 21%. The data in live will indicate the new levels in red, and an “R” is displayed to indicate the reference has been broken.

To update cue 1 part 2, including the new intensity levels, breaking the reference to the intensity palette, press:

- **[1] [Thru] [5] {Make Absolute} [Enter]**
- **[Update] <Cue> <1> [Part] [2] [Enter]**

To update cue 1 part 2 *and* the referenced palette with the new levels:

- **[1] [Thru] [5] [Intensity] [Update] <Cue> <1> [Part] [2] [Enter]**

For Example:

When cue 2 is active, select channels 1 through 5 and set new levels for the color scrollers. Update only part 4 of the multipart cue 2 with the new scroller levels.

- **[1] [Thru] [5] [Scroller] [Update] [Part] [4] [Enter]**

Storing a Multipart Cue in Blind



Note: *Edits in blind take effect immediately, they do not require a **[Record]** or **[Update]** command.*

Changing a Single Part Cue to a Multipart Cue

When working in blind, more often than not you will be breaking a single part cue into a multipart cue. It is quite possible to create a new cue in blind and follow the exact same process, except in addition to pulling channel parameters into parts, you will also be providing them with move instructions or block commands. It is worth noting that tracked instructions do not belong to any specific part of a multipart cue.

Select the cue you wish to break apart and specify the first part you wish to create. Part 1 is generally where the body of the cue resides. Therefore, if you specify any part other than part 1, all of the move instructions in the cue are placed in part 1.

Begin by selecting any channels that you wish to move into some part other than part 1.

- **[1] [Thru] [5] [Part] [2] [Enter]**
- **[6] [Thru] [1] [0] {Intensity} [Part] [3] [Enter]**
- **[6] [Thru] [1] [0] {Color} [Part] [4] [Enter]** - and so on.

As you create each part, that part is now selected. It is possible to select the channel parameter you want and press **[Part] [Enter]** to pull that data into the selected part.



Note: *When breaking a cue into a multipart cue in blind, the **[Part]** button is a required instruction. Channel selection will not automatically assign a channel into a part. Use of the **[Part]** key allows you to add only specific channel parameters to the part. For example:*

- **[5] [Thru] [9] {Color} [Part] [Enter]**

Changing a Multipart Cue to a Standard Cue

To change a multipart cue to a standard cue, delete all of the parts of the cue.

For Example:

Cue 4 is a 3 part cue that include channels 1 through 20. To change cue 4 back to a standard single cue:

- **[Delete] [Part] [1] [Thru] [3] [Enter]**

Deleting a Part from a Multipart Cue

When you delete parts of a multipart cue, any move instructions in the deleted part are moved to the first available part. If you want to delete move instructions out of a cue part, you have to select the channels and **[At] [Enter]** or null them.

- **[Delete] <Cue> [1] [Part] [1] [Enter] [Enter]**
- **[Delete] <Cue> [6] [Part] [1] [Cue Only/Track] [Enter] [Enter]**
- **[Delete] [Part] [1] [+] [2] [Enter] [Enter]**
- **[Delete] [Part] [1] [Thru] [3] [Enter] [Enter]**

Chapter 16

Cue Playback

Ion has many features that aid in cue playback. The playback section is located on the left side of the console and includes the master fader pair, grandmaster, load button, and the fader control button. Virtual faders (see [Fader Module, page 25](#)) and the fader wings can also be used in playback.

This chapter contains the following sections:

- [Introduction to Playback](#) 216
- [Selected Cue](#) 217
- [Out-of-Sequence Cues](#) 218
- [Assigning Faders](#) 220
- [Changing Fader Pages](#) 220
- [Playback Fader Controls](#) 221
- [Manual Master Cue Lists](#) 226

Introduction to Playback

Cues may be played back using the master playback fader pair. While any cue list can be loaded to these faders, the first cue list you record to will automatically load to the master fader pair.

The master playback fader pair is located to the left of the control keypad. The master is a split cross-fader pair. The two buttons beneath the master fader pair are **[Go]** and **[Stop/Back]**. The **[Load]** button is located directly above the fader pair and the area of the LCD above it corresponds as well, displaying the current cue and list active on the master fader.

For information about using the Universal Fader Wings, see [Universal Fader Wings, page 389](#).

Playback Controls

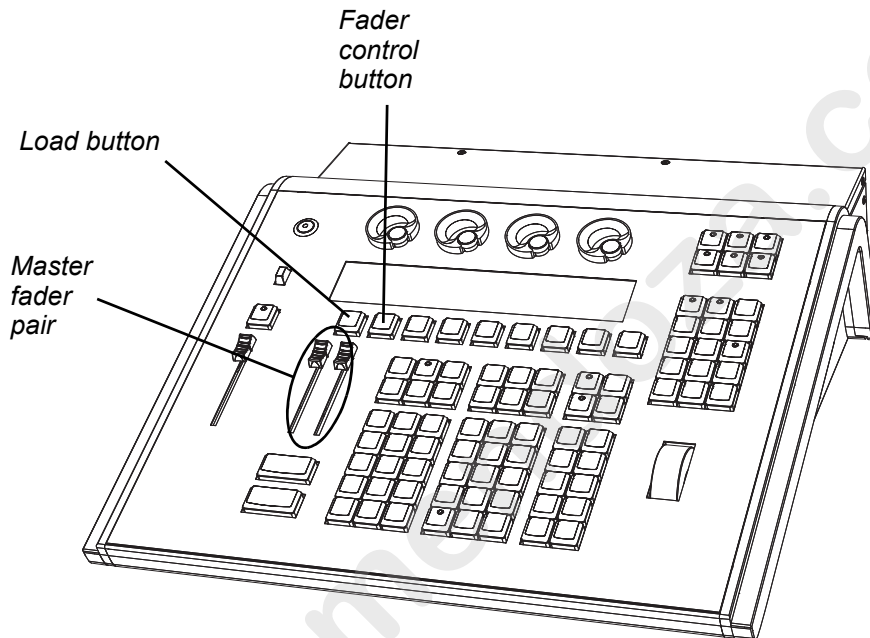

Selected Cue

The selected cue is always indicated just above the CIA. The selected cue and all of its attributes are displayed near the bottom of the live/blind display and on the playback status display.

Live / Blind

When working in live, the selected cue is always the last cue you recorded, edited, updated or played back. When entering blind for cues, the selected cue will be selected and displayed. Changing the selected cue in blind will cause the playback status display to change as well, unless preserve blind cue has been enabled in **Setup**, allowing you to see all the attributes of the cues surrounding the selected cue. When you return to live, the selected cue is synchronized to the currently active cue.

When in Live or Blind, if you press **[Live]** or **[Blind]** respectively, the selected cue will set to the last executed cue. This cue will appear on the command line.

The attributes of the selected cue (such as timing, attributes, label and external links) are shown at the bottom of the live/blind display, below the command line.

List 1		Timing																			
Cue	Int Up	Int Down	Focus	Color	Beam	Dur	M	B	A	P	A	M	F	V	Fw/Hg	Link	Loop	Curve	Rate	Label	Ext Links
1		5	5	5	5	2.5							L						200		Q6 / 1

In Live

To load a new cue to the faders, select the cue on the command line and then press **[Load]**. When the **[Go]** button is pressed, the activated cue will be the selected cue.

For Example:

Assume cue list 1 is currently loaded to the master fader pair. To load cue 2/1:

- **[Cue] [2] [/] [1] [Load]**

Cue 2/1 will load to the pending file of the master fader pair.

In this example, the last cue executed from cue list 1 is still the active cue, while cue 2/1 is pending. When **[Go]** is pressed, 2/1 will be executed.

You can also load cue list 2 by pressing **[2] [/] [Load]**. This will load the first cue of list 2 into pending.

The selected cue is changed by go, record, or update instructions as well as cue modification or selecting a cue on the command line. When you execute a cue that has a follow or hang time, the next cue will become the selected cue when activated.

In Blind

While in blind, changing the selected cue will change the playback status display to show information surrounding that cue.



CAUTION:

When editing in blind, changes to cues are automatic, therefore no update or record command is required.

While working in blind mode, cues can be executed in live using **[Go]**, **[Back]**, and **[Go to Cue]**, but this does not change the cue you are working with in blind.

Out-of-Sequence Cues

An out-of-sequence cue is any cue that is played back in one of the following ways:

- Cue is executed using a **[Go To Cue]** command.
- Cue is executed by a link instruction.
- Cue is loaded into a fader's pending file.
- Cue is re-executed using **[Assert]** & **[Load]** or is asserted from the command line.

Generally, when an out-of-sequence cue is executed, the entire contents of the cue will be played back (move instructions *and* tracked values).

For Example:

Cue 1 sets channel 1 to full. That value is tracked forward until cue 10. The programmer plays back cue 1 on fader 1. Then the programmer sets channel 1's intensity to 50% manually. If she executes cue 2, channel 1 remains at 50%, as it is a channel parameter that is not receiving a move instruction from the incoming cue.

However, if she presses **[Go to Cue] [5] [Enter]** (an out-of-sequence execution), even though the value for channel 1 in Cue 5 is a tracked value, channel 1 will fade from the manual value of 50%, to full in the Go-to-cue time.

Go To Cue

[Go to Cue] instructions can be executed from any operating mode. By default, a **[Go to Cue]** instruction is an out-of-sequence cue and will follow the rules of such (see [Out-of-Sequence Cues](#) above).

Following are examples of **[Go To Cue]**:

- **[Go To Cue] [5] [Enter]** - all parameters with values in cue 5 are faded to those values, even if they are tracked.
- **[Go to Cue] [6] [At] [5] [Enter]** - takes you to cue 6 at 50% of its fade completion. Hitting **[Go]** would finish the cue.
- **[Go To Cue] [Next] [Enter]** - takes you to the next cue in the active list.
- **[Go To Cue] [Last] [Enter]** - takes you to the previous cue in the active list.

When a **[Go To Cue]** instruction is executed, any null states applied with **{Make Null}** are removed. To maintain the make null setting, you should use **[Capture]** for the required channels.

Go To Cue Timing

[Go To Cue] uses go-to-cue timing established in [Setup, page 95](#). You can use a **[Go To Cue]** instruction with different timing options as follows:

- **[Go To Cue] [2] [Time] [1] [Enter]** - this command would take you to cue 2 in 1 second.
- **[Go To Cue] [3] [Time] [4] [/] [3] [Enter]** - this command would take you to cue 3 and all upfades and NP moves would have a time of 4 seconds and downfades of 3.
- **[Go to Cue] [Next] [Time] [3] [Enter]** - this command would take you to the next cue in the selected list in three seconds.
- **[Go to Cue] [Last] [Time] [2] [Enter]** - this command would take you to the previous cue in the selected list in two seconds.
- **[Go To Cue] [8] [Time] [Enter]** - this command would take you to cue 8 using all timing values stored in cue 8.

Other Go To Cue options

When **[Go to Cue]** is pressed, the softkeys in the CIA are changed to provide Go to Cue modifiers to enhance your playback ability.

From these softkeys, you can specify that when going to a cue, only some elements of that cue will be played back. Specifically you can choose to play back:

- single parameter channels only (conventionals),
 - **[GoTo Cue] [1] {SingleParam} [Enter]**
- multiple parameter channels only (moving lights),
 - **[GoTo Cue] [2] {MultiParam} [Enter]**
- move instructions only,
 - **[GoTo Cue] [3] {MovesOnly} [Enter]**
- use marks,
 - **[GoTo Cue] [5] {Use Marks} [Enter]**
- or you can choose play back a cue and withhold any link (follow, hang, execute instructions) it may contain.
 - **[GoTo Cue] [4] {MinusLinks} [Enter]**
- sets up the selected cue for manual control using a fader
 - **[Go to Cue] [6] [Time] {Manual} [Enter]**

These can be combined within the command line as well:

- **[Go To Cue] [1] {MultiParam} {MovesOnly} [Enter]**

[Go To Cue] [4] {Complete} [Enter] will go to cue 4 and if that cue has a follow/hang, any following cues in the sequence will also fire. This may look like you are going straight to the last cue in the sequence, but each cue will fire to make sure that any external links are fired.

[Go To Cue] [2] [At] [5][0] {Complete} [Enter] will go to cue 2 at 50% of its completion.

Cue lists other than the currently selected one can be homed as well by using the syntax, **[Go to Cue] [x] [/] [Home] [Enter]**. For example, **[Go to Cue] [2] [/] [Home] [Enter]** would execute the first cue of list 2.

[Go to Cue] [x] [/][Out] [Enter] allows you to use the **[Go to Cue] [Out]** command on a list specific basis. **[Go to Cue] [Out]** continues to affect all active cue lists.



Note:

***[Go to Cue] [x] [/][Out]** is similar to **[Go to Cue] [x] [/] [0] [Out]** except that any NPs on the fader will fade to their home level.*

[Go to Cue] [5] [Time] [Enter] will go to cue 5 using cue times, and also uses any associated follow/hang times to automatically trigger the subsequent cue. To go to a cue in cue time, but not trigger the follow/hang, you would use **[Go to Cue] [5] {Minus Links} [Time] [Enter]**.



Note:

*If you want to specify a time or use the cue time, the **[Time]** command must always be entered after any other commands, such as **{Minus Links}** or **{SingleParam}**. The exception to this rule is **{Manual}**.*

Slider Module

You can have access to multiple cue lists at once by using the virtual faders (see [Fader Module, page 25](#)) or fader wings. This will give you the ability to run multiple cue lists or submasters from multiple faders at the same time.

Assigning Faders

Playbacks and submasters can be defined on the fader pages in setup (see Setup, [Fader Configuration, page 98](#)). The location of playbacks and submasters can also be mapped live as the contents of those targets are stored. Grandmasters must be defined in setup.

If a fader is an empty playback, an empty submaster, or is unmapped, a cue can be loaded to that location by selecting the cue from the command line and clicking the associated **[Load]** key. On the fader wings, the load function is accessed by pressing both buttons associated with the fader. The fader will then be automatically assigned as a playback, using the lowest unused playback number.

Once a cue list is loaded to a fader, storing to that cue list automatically plays the cue back on the appropriate fader, when auto playback on record is enabled in **Setup**.

When a cue list is loaded to a playback, all cue attributes of that cue list are in effect. When a new cue list is loaded, any fader attributes that can be set as direct action from the facepanel (such as filters, timing disable, etc.) are maintained. Loading a new cue does not change the manual fader attributes.

With Auto Playback Enabled

“Auto Playback” is a record function enabled in setup ([Setup, page 95](#)), that automatically executes cues recorded in live on playback faders. When the cue is executed on the playback fader, any manual parameters involved in the record operation are automatically released to the cue and all other values stored in the cue are owned by that cue.

When the first cue is stored on Ion, that cue automatically loads on the master fader.

Assigning Playback Faders Manually

To load a new cue into the pending file of a playback fader, when “Auto Playback” is disabled in setup or when you want to move a cue list to a different fader, first place that cue or list number on the command line, press **[Enter]**, then click or press the associated **[Load]** button for the destination playback fader.

- **[Cue] [4] [Load]** - changes the selected cue and loads it to the associated fader. This action assumes cue 4 is from the same cue list as is currently selected.
- **[Cue] [3] [N] [Load]** - changes the selected cue list and loads cue list 3 to the associated fader.

Changing Fader Pages

Ion has 30 pages of ten faders each. When using virtual faders, you can page through the 30 available pages of faders by clicking the desired page in the virtual fader display. Click the arrow buttons to advance through the page number buttons until you find the desired page. When using fader wings, holding down **[Fader Page]** and bump buttons 1-30 (if available) will change to the appropriate page.

Playback Fader Controls

In Ion, many of the buttons mentioned below exist as softkeys. In order to have access to some of these keys, press **[Fader Control]**. The softkeys will change to display the fader control keys. You may press **[More SK]** if the green LED is illuminated, to view additional fader control buttons.

Go and Stop/Back

Using [Go]

The **[Go]** button is used to execute the cue currently in the pending file of the associated fader. When **[Go]** is pressed, all parameters assume their required positions in the recorded times, unless they have been recorded with manual timing.

Using [Stop/Back]

All fader activity can be instantly stopped mid-transition by pressing the **[Stop/Back]** button for the required fader. To resume the cue, press the **[Go]** button. To fade to the previous cue on that fader, using default “back” timing, press the **[Stop/Back]** button again from this state.

When a cue on the playback fader is complete, pressing **[Stop/Back]** will step backwards sequentially through the cue list from that point. **[Stop/Back]** uses default back time as established in **Setup**. See [“Cue Settings” on page 99](#). Or you can back into the previous cue using specific timing by pressing:

- **[Go to Cue] [Last] [Time] [n] [Enter]**.

Using Blackout

It is possible to blackout a physical fader that is assigned as a grandmaster by pressing the fader’s **[Go]** & **[Stop/Back]** buttons at the same time. Pressing **[Go]** & **[Stop/Back]** again will exit blackout.

[Go To Cue] [0]

You can use the **[Go To Cue] [0]** button, located with the playback controls, in conjunction with a fader load button, to send a specific cue list to cue 0. This action does not use the command line. To do this:

- Step 1: Press **[Fader Controls]**
- Step 2: If necessary, press **[More SK]** until {Go To Q 0} is visible in the LCD.
- Step 3: Press and release **{Go To Cue 0}**.
- Step 4: Press or click **[Load]** for the desired fader. The cue list will go to cue 0.

For more information on this action, see [Using Go To Cue 0, page 207](#).

Using Manual Control

There are three types of manual control for playbacks:

- Cues can be stored with manual timing. When cues have stored manual timing, the default behavior of the fader is to control those manual values.
- Cues can be captured for manual intensity control only. This is possible only when the associated cue has no manual timing values.
- Cues can be manually overridden using the **[Man Override]** & **[Load]** feature which captures all parameter transitions.

In each of these cases, follow time counts down from **[Go]**. The hang time will be started when the potentiometer reaches full or when the last parameter reaches its end state from timing, whichever comes last.

Manual Timing Control

Manual timing can be set for any parameter or group of parameters. The potentiometer is then used to control the progress of a transition.

For Example:

Assume the active cue contains an instruction to set color at 5 for channel 1.

The pending cue contains an instruction to set channel 1 to color 12 and the color parameter has a manual time. Press **[Go]** to activate the cue. Channel 1 color does not change.

As you move the fader up manually, channel 1 color moves proportionally from color 5 to color 12. Any parameters with timing will start their moves at the press of **[Go]** and be unaffected by the manual control.

To program a channel manual time:

- **[1] {Color} [Time] {Manual} [Enter]** - assigns a manual time to channel 1. This must be recorded or updated to a cue.

Manual timing can also be set at a cue level:

- **[Record] [Cue] [5] [Time] {Manual} [Enter]**

Manual timing can also be set at a cue category level:

- **[Record] [Cue] [6] [Color] [Time] {Manual} [Enter]**

Manual Intensity Override

An intensity transition may be taken over manually and the transition captured by dropping the fader down until it reaches the percentage of cue completion (i.e. if the cue is 50% complete, when the fader is manually dropped to 50%, the intensity transitions will be captured and the intensity portion of the cue completed by moving the fader manually between 50% and full or anywhere in between). If the fader is dropped below 50%, the fader will fade all intensity values proportionally from their captured values to their previous values.

If a fade is captured and the faders are not reset to 100% prior to the next press of the **[Go]** button, the fader will automatically reset to 100% upon cue execution. Alternatively, you can set the fader to 0% before executing the next cue to capture the cue for manual intensity control when the **[Go]** button is pressed if the fader is set to proportional control. Intensity control is released from the fader when the cue is considered complete (when the fader is brought back to 100%). If the fader is set as an Intensity Master, the intensity control is maintained, even when the cue has completed.

If a pending cue has any manual control properties, you may either preset the fader to zero or, if it is a virtual fader, the console will automatically set the fader to zero when the **[Go]** button is pressed. The master fader pair must be manually set.

Manual intensity override is not possible if there is any manual timing in the cue, as the potentiometer is already occupied with that control.

Manual Override

Manual override allows the potentiometer of the associated fader to control all parameters in a transition state on that fader. When **[Fader Controls]** **{Man Override}** & **[Load]** are pressed, all activity on that fader is frozen.

The potentiometer is used to manually complete the cue transition for all parameters. If the fader is operating in a paired mode, the left fader controls the intensity upfade and all non-intensity parameters, while the right fader controls all intensity downfade actions. Manual control override automatically releases when the cue is complete.

A group of faders can be collected for manual override by pressing or clicking **[Man Override]** & **[Load]** (continue adding faders by clicking the associated **[Load]** buttons).

Using Assert (Playback Button)

Use **{Assert} & [Load]** for the associated fader to re-run the active cue in that fader, following the same rules as **[Go To Cue]**. Assert can be used to regain control of all cue contents, apply a newly set independent state to the associated fader, or make any changes in blind to an active cue on stage.

When **[Fader Controls] {Assert} & [Load]** are used together, the entire contents of the cue are replayed. You can assert just certain elements of a cue by using the command line.

Following are some examples of asserting elements of a cue from the command line:

- **[channel list] [Assert] [Enter]** - asserts the selected channels with values from cue 5. Note that cue 5 must be active for this command to execute.
- **[channel list] [Color] [Assert] [Enter]** - asserts the color values from cue 1 for the selected channels. Note that cue 1 must be active for this command to execute.
- This would then need to be stored using **[Record]** or **[Update]**.

Using Timing Disable

The **{Time Disable}** softkey, used with **[Fader Controls]** and **[Load]**, causes timing data to be ignored for any cues that are activated on the associated playback fader. When a playback fader is in timing disable mode, you will notice “TD” in the associated fader display.

To release the playback fader from time disable mode, press **[Fader Controls] {Time Disable} & [Load]** again. You can also cut the next cue in by pressing **[Timing Disable] & [Go]** or the last cue by pressing **[Timing Disable] & [Back]**.

They will snap from move instruction to the next move instruction in a time of zero.

Using Freeze

{Freeze} can be used to halt all effect activity on any active faders. To activate a freeze for only a specific fader, press **[Fader Controls] {Freeze} & [Load]**.

There are two ways to remove the freeze command:

- Press **{Freeze} & [Load]** again for the specific faders to unfreeze the activity.
- Press **{Assert} & [Load]** or **[Go]** or **[Stop/Back]** for the specific faders to resume the activity.

You may freeze and unfreeze effects from the command line.

- **[Effect] [2] [Fader Controls] {Freeze} [Enter]** - to freeze effect 2. Freezing a specific effect is different from stopping an effect. Freeze will stop the effect exactly where it is.
- **[Effect] [6] [Thru] [9] [Fader Controls] {Freeze} [Enter]** - to freeze a specified range of effects.

When an effect is in freeze mode, you can use the same command to unfreeze:

- **[Effect] [2] [Fader Controls] {Freeze} [Enter]**
- **[Effect] [6] [Thru] [9] [Fader Controls] {Freeze} [Enter]**

Using Stop Effect

The **{Stop Effect}** softkey can be used to stop all effects from operating on any or all faders, or it may be used with the control keypad to stop a specific effect.

- To stop all effects on a fader, press **[Fader Controls] {Stop Effect} & [Load]** of the associated fader.
- To stop a specific effect regardless of the fader it is operating on, press **[Effect] [2] [Fader Controls] {Stop Effect} [Enter]**.

When an effect is stopped, all impact of the effect is removed and the stage output is as though the effect has never been activated.

Releasing Content From a Fader

There are a few ways to release content from a playback fader:

- **[Fader Control] {Off} + [Load]** - returns control to the background fader, either a cue or a submaster, and stops any effects that are running on that fader. If there is no background value, the intensities will just fade out.



Note: *Associated pending and current cues will remain when using **{Off} + [Load]**. Pressing **[Go]** will run the cues in their current sequence.*

- **[Fader Control] {Release} + [Load]** - behaves like **{Off} + [Load]** except that it sets the pending cue to the first cue in the list and removes the active cue.
- **[Shift] + [Load]** - behaves like **{Release} + [Load]** except that it removes the content entirely from the fader. Pressing **[Shift] + [Load]** on an empty playback fader will unmap the fader.



Note: *The **[Go To Cue] [Out]** command can be used to clear out all background LTP fader values.*

Using Rate Override

To collect a playback fader for rate control, press **[Fader Controls] {Rate} & [Load]** for the required fader. When **{Rate}** is pressed without **[Load]**, it always collects the master fader for rate control. A subset of faders can be collected by pressing and holding **{Rate}** while clicking the **[Load]** button for the associated faders you would like to add. When no faders are under rate control, pressing **[Rate]** collects the master fader for rate override.

Use the rate encoder to adjust the rate dynamically. The default is 100%, which is real time (example: 5 seconds = 5 seconds). Decrease the percentage to slow the cue down. Setting the rate to 0% will stop the cue. Increase the percentage to speed up the event.

Following are some examples of rate:

- A 50% decrease rate applied to a 5 second event will play the cue in 10 seconds.
- A 200% increase rate applied to a 5 second event will play the cue in 2.5 seconds.

The top rate adjustment is 2000%. All timing values associated with a cue (including any follow or hang times) are affected by the rate modification proportionally.

If a cue is complete, any rate adjustment applied affects the cue in the pending file. When that cue is subsequently activated, the adjusted rate is used to direct timing. Pressing **{Rate}** again will turn rate control off and reset to 100%

Manual Master Cue Lists

Manual master is an additional condition for cue playback. In this mode, cues are triggered manually by faders without using the **[Go]** button. With a cue list on a fader set to manual master, a cue will fire in manual time when the fader is moved from 0% or from Full. This is all done without hitting **[Go]**. Any cues in a manual master list not fired by moving a fader, but triggered via **[Go]** instead, will fade according to cue's timings.



Note: *Follow and hang times will be ignored when firing a cue with a manual master fader.*

To set a cue list to manual master, use the **{Fader}** softkey in the Cue List Index. To access the cue list index, press **[Cue] [Cue]**. **{Fader}** will toggle between Proportional Master, Intensity Master, and Manual Master. The default is Proportional Master.

When manual master has been selected as the fader mode for a cue list, the initials 'MM' will appear above the cue list label field. Initials 'IM' will display when set to intensity master mode.

Timing is scaled. So, if color has a 5 count delay, and the duration of the cue is 10, the color transition will not begin until the faders manually reach 50%.

The screenshot shows a cue list interface with the following columns: Cue, Int Up, Int Down, Focus, Color, Beam, Dur, Flags (MB A P A M F V), Fw/Hg, Link, Loop, Curve, Rate, Label, and Attributes. The 'Attributes' column contains 'MM', which is circled in yellow. The 'Cue' column has values 1 and 2. The 'Int Up' column has values 5 and 5. The 'Int Down' column has values 5 and 5. The 'Focus' column has values 5 and 5. The 'Color' column has values 5 and 5. The 'Beam' column has values 5 and 5. The 'Dur' column has values 5 and 5. The 'Flags' column has a 'D' in the first row. The 'Fw/Hg' column has a 'D' in the first row. The 'Link' column has a 'D' in the first row. The 'Loop' column has a 'D' in the first row. The 'Curve' column has a 'D' in the first row. The 'Rate' column has a 'D' in the first row. The 'Label' column has a 'D' in the first row. The 'Attributes' column has 'MM' in the first row.

For more information about the other modes available, see [Fader type, page 210](#).

Chapter 17

Advanced Manual Control

This chapter describes some more advanced features for manual control functions. These features can save you valuable programming time.

This chapter contains the following sections:

- **Using [Copy To]** 228
- **Using [Recall From]** 229
- **Using {Make Null}** 230
- **Using {Make Manual}** 231
- **Using {Make Absolute}** 231
- **Using {Query}** 232
- **Using [Capture]** 233
- **Using [Undo]** 234

Using [Copy To]

[Copy To] allows you to copy all data from one channel to another, either within the current working mode or to a different record target. **[Copy To]** works much like **[Recall From]**, but in the opposite direction, **[Copy To]** forces data *to* a channel from the selected channel, whereas **[Recall From]** pulls it *from* a channel to the selected channel.

By using the IFCB category buttons or parameter buttons, you may copy subsets of channel data. Entire cues, cue ranges and cue lists can be copied to other locations. To only copy over intensity and parameter levels, use the **{Only Levels}** softkey. This will exclude discrete timing information.

To copy over data from only active channels, use the **{Only Active}** softkey.



Note: *The **{Only Levels}** and **{Only Active}** softkeys can be used with **[Recall From]** and **[Copy To]** if no channel selection had been previously made.*

When referenced data is copied, if the copy target also has data in the reference that is being copied, the target will be placed in that reference (such as, CP 1), at its stored values. If the copy target is not included in the reference, absolute data will be copied to the target, and not the reference.

Below are some examples of copy commands from record targets. This command is very versatile and the following list is far from exhaustive:

- **[2] [Copy To] [Cue] [5] [Enter]** - copies all information for channel 2 to cue 5.
- **[2] [-] [Focus] [Copy To] [Cue] [5] [Enter]** - Copies all parameter data for channel 2, other than focus, to cue 5.
- **[Group] [3] [Copy To] [Preset] [6] [Enter]** - copies current information for group 3 to preset 6.
- **[3] [Copy to] [6] [Cue] [8] [Enter]** - copies the data from channel 3 to channel 6 in cue 8.
- **[3] [Copy to] [4] [Thru] [9] [Enter]** - copies the data from channel 3 to channels 4 thru 9.
- **[3] [Copy to] [8] [Cue] [2] [/] [1] [Cue Only/Track] [Enter]** - copies the data from channel 3 to channel 8 in cue 2/1 and takes exception to the track/cue only settings in regard to subsequent cues in cue list 2.
- **[Cue] [2] [/] [Copy to] [Cue] [7] [/] [Enter]** - copies all of the contents of cue list 2 to cue list 7.
- **[Cue] [1] [/] [1] [Thru] [1] [0] [Copy To] [Cue] [5] [/] [5] <Thru> [Enter]** - copies cues 1 thru 10 from cue list 1 to cue list 5, starting with cue 5.
- **[1] [Copy To] [2] [0] {Only Levels} [Enter]** - copies only the intensity and parameter information from channel 1 to channel 20.

In live, you can use **[Sneak]** with **[Copy To]** to fade in the change.

For example, **[1][2] [Copy To] [2] [Sneak] <Time> 7 [Enter]** would copy the recorded data from channel 12 to channel 2 and sneak it in 7 seconds.

Using the **{HTP}** softkey with **[Copy To]** will cause any intensity levels to be ignored if they are less than or equal to the copied value.

For example, channels 1 and 2 are at 50% in cue 10, and in cue 11 channel 1 is at 10% and channel 2 is at full. If you are in cue 11, and use the syntax **[1] [Thru] [2] [Copy To] [Cue] [1][0] {HTP} [Enter]**, channel 1 will remain at 50% and channel 2 will go to full.

Using [Recall From]

[Recall From] is similar to **[Copy To]**, except that it retrieves data from other locations, and can be used only for a channel list recalling from the same channel list but in a different location (for example, a cue). **[Recall From]** is essentially a “copy from” command.

All parameter data for selected channels will be recalled, or by using the IFCB category buttons or parameter buttons, you may recall subsets of channel data. To only recall only intensity levels, use the **{Only Levels}** softkey.

To recall data from only the active channels, use the **{Only Active}** softkey.



Note: *The **{Only Levels}** and **{Only Active}** softkeys can be used with **[Recall From]** if no channel selection had been previously made.*

In live, you can use **[Sneak]** with **[Recall From]** to fade in the change.

Below are some examples of recall commands from record targets:

- **[2] [Recall From] [Cue] [5] [Enter]** - recalls all recorded data from cue 5 for channel 2.
- **[2] [-] [Focus] [Recall From] [Cue] [5] [Enter]** - recalls all data for channel 2 from cue 5, except focus (pan/tilt - XYZ) data.
- **[Group] [3] [Color] [Focus] [Recall From] [Preset] [6] [Enter]** - recalls the color and focus information from preset 6 for the channels in group 3. Could also be used with a channel selection set instead of a group.
- **[Group] [3] [Color] [Recall From] [Cue] [7] [Make Absolute] [Enter]** - recalls color data for group 3 from cue 7 and breaks any references to record targets.
- **[2] [Recall From] [Sub] [4] [Enter]** - recalls all recorded parameter data from sub 4 for channel 2.
- **[Recall From] [Intensity Palette] [1]** - recalls all of the values stored in intensity palette 1.
- **[1][0] [Recall From] [Cue] [2] [Sneak] <Time> 7 [Enter]** - would recall the recorded data that cue 2 has for channel 10 and sneak it in 7 seconds when used in live.
- **[Recall From] [Cue] [1][0] {Only Active} [Enter]** - recalls data from only the active channels, which are those channels with intensities above 0, if no channel selection had been previously made.
- **[Recall From] [Cue] [2] [Enter]** - would result in a selection of the channels used in that cue. Any channels that are used in the cue list but do not currently have an intensity in the recalled from cue will be set to zero. Pressing **[At]** afterwards would post a numeric list of those channels to the command line.



Note: *In live or blind, hitting **[Recall From][Recall From]** will put **[Recall From] [Cue]** on the command line.*

Using the **{HTP}** softkey with **[Recall From]** will cause any intensity levels to be ignored if they are less than or equal to the recalled value.

For Example:

Channels 1 and 2 are at 50% in cue 10, and in cue 11 channel 1 is at 10% and channel 2 is at full. If you are in cue 10, and use the syntax:

- **[Recall From] [Cue] [1][1] {HTP} [Enter]**

Channel 1 will remain at 50% and channel 2 will go to full.

Using {Make Null}

The **{Make Null}** softkey can be used to withhold parameter data from record or update actions in live, and remove parameter data from record targets in blind. **{Make Null}** is applied using channel selection and can impact entire channels, individual parameters, or parameter categories.

In Live

When you apply a **{Make Null}** instruction to channels or parameters in live, channel data is still visible onstage, but that data is essentially rendered invisible to record commands. Similar to filters (see [Record Filters, page 200](#)), **{Make Null}** acts as an “ignore” instruction in live, not a remove instruction. When channel data is nulled, the values for that data in the live display turn grey and an “N” appears next to the data field.

{Make Null} differs from park in that you can still manipulate data onstage (through manual control or through playback) but that data will be unavailable for record actions.

Some examples of using **{Make Null}** in live are:

- **[1] [Thru] [5] {Make Null} [Enter]** - converts all parameters of channels 1-5 into null data.
- **[2] {Color} {Make Null} [Enter]** - changes only color data for channel 2 to null data.
- **[9] [Thru] [5] {Pan} {Make Null} [Enter]** - changes only the pan data for channels 5-9 to null.

Null instructions are lifted in two different ways. First, as **{Make Null}** is a toggle state, it is possible to reselect the channel and parameter followed by **{Make Null} [Enter]**. This lifts the null state.

Additionally, a Go To Cue instruction will remove the null state.

In Blind

When applied in blind, **{Make Null}** can be used to mask instructions in a cue *after* it has already been stored. A **{Make Null}** instruction can also be applied to channels or parameters in palettes, presets, and submasters, thereby removing the data from the target entirely, in the same way that **[At] [Enter]** does.

When applied to channels or parameters in cues, **{Make Null}** doesn't remove the data from the cue, it simply makes it unavailable for playback. It has the same effect on move instructions that it has on tracked values.

Some examples of using **{Make Null}** in blind are:

- **[Color Palette] [1] [Enter] [3] {Magenta} {Make Null} [Enter]** - removes all magenta parameter data for channel 3 from color palette 1.
- **[Preset] [5] [Thru] [9] [Enter] {Intensity} {Make Null} [Enter]** - removes all intensity data for all channels in presets 5-9.
- **[Cue] [8] [Enter] [2] [Thru] [7] {Make Null} [Enter]** - nulls all data for channels 2-7 in cue 8.
- **[Cue] [9] [Enter] {Intensity} [Make Null] [Enter]** - nulls all intensity data for all channels in cue 9.

In the cue scenarios above, **{Make Null}** differs from using **[At] [Enter]** in that instead of allowing values established in previous cues to track in, **{Make Null}** both restricts the recorded data from playing back and prevents other values from tracking in. Therefore, if the cue were executed as an out-of-sequence cue or asserted, no data would play back or track in for any nulled values.

Using {Make Manual}

The **{Make Manual}** softkey can be used to convert cue or submaster data into manual values, allowing it to be included in **[Record]**, **[Record Only]**, and **[Update]** operations.

- **[5] {Make Manual} [Enter]** - selects channel 5 and makes all of its current parameter settings manual data.
- **[8] {Focus} {Make Manual} [Enter]** - selects channel 5 and makes all of its focus data manual.
- **[9] [Thru] [3] {Color} {Intensity} {Make Manual} [Enter]** - selects channels 3-9 and makes their color and intensity values manual.

Using {Make Absolute}

Referenced data can be transformed into absolute data using the **{Make Absolute}** softkey. This softkey is available in live or blind. Referenced data is channel or parameter data that is derived from a palette or preset. **{Make Absolute}** can be used to leave a parameter unchanged, but break its palette or preset reference.

The following examples illustrate how to change referenced data into absolute data.

- **[4] {Make Absolute} [Enter]** - selects channel 4 and makes any referenced data for that channel absolute data.
- **[7] {Color} {Make Absolute} [Enter]** - selects channel 7 and makes its color data absolute.
- **[3] [Thru] [9] {Color} {Intensity} {Make Absolute} [Enter]** - selects channels 3-9 and makes their color and intensity data absolute.

In each of these examples, the channel display will change to show the result of the command. Wherever the reference was previously indicated (IP, FP, CP, BP, Pr), an absolute value (numerical) will be seen.

In live, data that is changed to absolute is also made manual, thereby requiring a record or update instruction if the results are to be maintained.

{Make Absolute} can also be used in conjunction with an update command, allowing a cue to be updated while also breaking the reference to palettes or presets that were manually modified.

For example, **[Update] {Make Absolute} [Enter]** will update the active record target. Any manual values that were modifications to a palette or preset stored in the cue will be updated as absolute data in the cue. The reference will be discarded.

Using {Query}

{Query} is used to select channels that meet criteria specified by you. These selections are conditional, based on what type of luminaire a channel is or what that channel is doing, isn't doing, can do or cannot do. These criteria are established in the command line using the softkeys, the keypad, and the direct selects.

When **{Query}** is used, the softkeys change to:

- Is In
- Isn't In
- Can Be
- Can't Be
- Or
- Moves Only



Note:

*Unless otherwise specified, Ion assumes that a query will apply to current output. Therefore use of the **{Is In}** softkey is optional.*

The CIA also repaints to display the available keywords and fixture types by which you can search. These can be used in defining your query criteria.

As a query is defined in the command line, channels will be specified in the Live/Blind display. When an **[Enter]** command is used to end the query, the remaining channels of the query will be selected.

For Example:

You wish to find channels which are in color palette 2 and have an intensity of 50%:

- **{Query} <Is In> [Color Palette] [2] [At] [5] [0] [Enter]**

In the Live/Blind display, any channels meeting this criteria will be selected.

You may use **[Next]** and **[Last]** to cycle through the query selection, one channel at a time to control only a specific channel.

Other examples of using a query are:

- **{Query} {Isn't In} [Beam Palette] [2] [5] [Enter]**
- **{Query} {Luminaire} {Can Be} [Focus Palette] [8] [Enter]**
- **{Query} {Fixture Type} {Revolution} {Can Be} [Focus Palette] [6] {Isn't In} [Cue] [4] [Thru] [9] [Enter]**
- **[Next] [Next] [Enter]** - selects one channel from the query result.

Additionally, in patch you can define up to four "query" keywords for each channel. These keywords can be used to create a query condition as well (See [Keywords, page 83](#)).

Keywords defined in patch will appear in the CIA when **{Query}** is pressed. They can then be used in a query like this:

- **{Query} {Your keyword} {Can't Be} {Beam Palette 5} [Enter]**

Buttons on the facepanel, such as **[Time]** can also be used to construct a query.

Using [Capture]

Capture is a manual independent state. Any captured channel parameter data will be unaffected by playback, but will respond to manual control operations.

When channels are selected, **[Capture] [Enter]** captures all parameters of those channels. They will remain unavailable for playback or submaster override until they are released from the captured state. Capture is a toggle state, so to release parameters from a captured state, press **[Capture] [Enter]** again.

For Example:

- **[1] [Thru] [9] [At] [Full] [Capture] [Enter]**

A “C” is displayed next to the captured parameters (intensity) in the channel display. The selected channels are now captured and are unavailable for playback or submaster instructions until they are released from capture.

You may also capture specific parameters of a channel using the parameter buttons in the CIA.

For Example:

- **[7] [Focus] [Capture] [Enter]**

If a group of channels are selected, and some of those channels are captured and some are not, the first press of **[Capture]** releases all channels from the captured state and the second press captures all manual settings for the selected channels.

Uncaptured channels remain at their current values until restored to previous values or a new instruction is provided. You may restore channels to their background or default state using the **[Sneak] [Enter]** feature (see [Sneak, page 130](#)). Or you may leave them in a manual state until a new instruction is received.

It is also possible to “latch” capture on. This will automatically capture all manual changes as they are made. Pressing **[Capture] [Capture] [Enter]** automatically captures subsequent manual changes. The command line will read “Capture Enable” and the Capture LED will illuminate. To remove the capture latch, press **[Capture] [Capture] [Enter]** again.

Using [Undo]

Undo is a method to reverse or “undo” certain operations performed in the software. You can use **[Undo]** to reverse any command that results in a change to data that would be saved to the show file or any command that changes manual levels in live.

If there are any commands in the command line, pressing **[Undo]** once clears the command line. Once the command line is empty, pressing **[Undo]** will start the undo process. **[Shift] + [Clear]** can be used to clear the command line.

When **[Undo]** is pressed from an empty command line, the command history display will open in the CIA and the most recent completed command is highlighted in gold. If you press **[Enter]**, you will undo your last command. This will exclude discrete timing information.

Command History	
Mode	Command
Eos	[Fixture : Patch]
BLIND: Curve 1	Curve 1 Interpolate
LIVE:	Chan 1 Thru 10 @ Full
BLIND: Preset 107	Delete Preset 107
LIVE:	Record Preset 31

Commands to be undone

You may use the page arrow keys to select multiple commands. When **[Enter]** is pressed an advisory is posted. When **[Undo]** is pressed again, all highlighted commands will be undone and subsequently removed from the command history. When removing more than one command, a confirmation is required.

After an Undo has been performed, a **{Redo}** button will appear in the command history. You may press this button followed by **[Enter]** and the last undo will be “redone” to reinstate the removed commands.

In a multiple user environment, each user is only able to undo the changes that they made. In the undo command history, the user will only see the commands that they used.



Note:

Not all commands can be undone including playback actions and manual attributes placed on channels or encoder actions.

Command History

Command histories are kept for each editing session, which begins when:

- a desk logs on to the network
- a new show file is loaded
- a show file is opened, merged, or imported

Each user builds an individual command history, specific to the commands *they* have entered.

You can open the command history at any time by pressing **<More Sk> {Cmd History}**.

Commands that do not affect manual input or record targets (loading a cue, running a cue, or moving a submaster) are not included in the command history.

Chapter 18

Using Park

This chapter describes using park functions from both the live and park display.

This chapter contains the following sections:

- **Park Display** 236
- **Parked Values in Live** 236
- **Scaled Parked Values in Live** 237
- **Parked Addresses in Live** 237
- **Park Values from the Park Display** 238

Using Park

The park instruction allows you to set a channel or parameter to a specific value and have it remain at that level on stage (live mode), prohibiting manual control override, cue or submaster playback modification. Park may also be used to place a scaling instruction on the intensity output of a channel.



Note: *A parked channel intensity is not impacted by grandmaster or blackout operations.*

Parked values are withheld from all record targets, but you can manually set levels for parked channels and parameters and store those values into record targets. Keep in mind that the values set and stored in live do not actually output to the system if the parameter is parked.

When channels or parameters are parked, the LED on the **[Park]** button illuminates and the live display will indicate “Parked Channels” or “Parked Dimmers” in the top right corner. In addition, any parked channel or parameter will be indicated with a white channel number and a “P” will be visible in the channel. When the parked channel or parameter is unparked, it reverts to the level the console is currently providing, or its default value if there is no current instruction.

Park instructions are not subject to partitioned control. Any programmer or operator may park and unpark channels or parameters as needed. Parked parameters set by radio focus remotes (RFR) will automatically unpark when the associated device goes offline.

Channels, parameters and outputs can be parked and unparked from live and from the park display.

Park Display

You can access the park display by pressing **[Park]** **[Park]** or **[Blind] & [Park]**. The park display shows all parked channels and parameter values on the top half of the screen and all parked addresses (dimmers) on the bottom half of the screen. Parked channels displayed on the top of the screen can be displayed in the summary, table, and packed table views seen in the live/blind display by using the **[Format]** key.

When a channel intensity is parked, the parked value will be indicated in white text. When a channel has a non-intensity parameter that is parked, that parameter will also be indicated with white text. The display also provides detail of which user parked the channel or parameter (when multiple users are on the system).

When an address is parked, it will appear in the bottom half of the park display. The address, parked value, affected channels and parameters are indicated.

Parked Values in Live

Channels and parameters may be parked and unparked from the live display. Following are some examples:



Note: *Parked values will only be displayed in the park display.*

To park a channel, parameter, or group from live:

- **[2] [At] [5] [0] [Park] [Enter]** - parks channel 2 intensity at 50%
- **[2] [Intensity] [Park] [Enter]** - parks the intensity of channel 2 at its current value
- **[2] [Park] [Enter]** - parks all parameters of channel 2 at their current settings



Note: *If a channel list is constructed in which some channels are parked and some are unparked, **[Park] [Enter]** will unpark them all. A confirmation will be required.*

- **[2] [At] [Park] [Enter]** - if channel 2 is unparked, this command parks intensity at the current value. If the intensity for channel 2 is parked, this command unparks intensity.
- **[2] [Color Palette] [8] [Park] [Enter]** - parks the color for channel 2 in color palette 8.
- **[2] [Color] [Park] [Enter]** - parks channel 2 color at its current value.
- **[Group] [Cue] [6] [Park] [Enter]** - parks all the channels stored in cue 6 at their levels provided in the cue.
- **[Park] [Enter]** - clears all parked channels and scaled park instructions (see [Scaled Parked Values in Live, page 237](#)). A confirm is required. When a channel is unparked, it reverts to the level the console is currently providing, or its default value if there is no current instruction. A confirmation will be required.

Scaled Parked Values in Live

A scaled parked value allows the intensity output (only) to be modified proportionally in live. Scaled park values are ignored when storing a record target. The setting on the display indicates what should be stored, not the actual scaled value. An example of how to set a scaled parked value in live includes:

- **[3] [At] [/] [1] [2] [5] [Park] [Enter]** - sets a scaled value of 125% on channel 3 intensity. In other words, whenever channel 3 is active, it will be active 25% higher than its current setting.
- **[3] [At] [/] [8] [5] [Park] [Enter]** - sets a scaled value for channel 3. Whenever channel 3 is active, it will playback 15% lower than its current setting.

Remove the scaled parked value:

- **[3] [At] [/] [Park] [Enter]** - unparks a scaled intensity for channel 3.
- **[Park] [Enter]** - unparks all parked channels.

A channel can have both a scaled parked value and a parked intensity value. Keep in mind that the parked intensity has priority over (and overrides) scaled park values. A channel can have a parked value or a scaled park value, but not both.

Parked Addresses in Live

DMX addresses can be parked in Live. When in live, an **{Address}** softkey exists beneath the CIA.

Below are some examples of parking an address in live:

- **{Address} [5] [At] [5] [0] [Park] [Enter]** - parks output 5 at 50% intensity.
- **{Address} [5] [Park] [Enter]** - unparks output 5. A confirmation will be required.
- **{Address} [Park] [Enter]** - unparks all parked outputs. A confirmation will be required.

Park Values from the Park Display

You can park and unpark channel parameters or addresses from the park display. Open the display by pressing **[Park] [Park]** or **[Blind] & [Park]**. While in this display, it is assumed that you want to park channels or parameters, therefore the use of the **[Park]** key is not necessary when parking, but is used for unparking. You can also use **[At] [Enter]** to unpark.

Following are examples for parking channel parameters from the park display:

- **[3] [At] [4] [5] [Enter]** - parks channel 3 at 45%.
- **[3] [Color Palette] [4] [Enter]** - parks color for channel 3 at color palette 4.

Following are examples for clearing parked values while in the park display:

- **[channel list] [Park] [Enter]** - unparks channels in the list.
- **[channel list] [At] [Enter]** - unparks channels in the list.

Below are examples for parking addresses in the park display:

- **{Address} [5] [At] [5] [0] [Enter]** - parks address 5 at 50% intensity.
- **{Address} [5] [At] [Enter]** - unparks address 5.

The screenshot shows the 'Park Channels' display for 'Angela's Ascent' at 9:45:25 AM. The top section displays a grid of channel parameters, with values ranging from 50 to 65 and 'FL' (Flashed) for channels 10-130. The bottom section displays a table of parked addresses, with columns for Address, Value, Channel, and Param. The table is divided into three sections: 97-111, 112-155, and 300-306. A yellow line highlights the 'Address 119 Park' button at the bottom of the table. A yellow arrow points from the text 'Parked addresses' to the table, and another yellow arrow points from the text 'Parked channels' to the top grid.

Address	Value	Channel	Param
97	255	97	Intens
98	255	98	Intens
101	255	101	Intens
102	255	102	Intens
103	255	103	Intens
104	255	104	Intens
105	255	105	Intens
106	255	106	Intens
107	255	107	Intens
108	255	108	Intens
109	255	109	Intens
110	255	110	Intens
111	255	111	Intens
112	255	112	Intens
113	255	113	Intens
114	255	221	Intens
115	255	223	Intens
116	255	116	Intens
117	255	117	Intens
118	255	222	Intens
120	255	224	Intens
121	255	321	Intens
122	255	321	Intens
123	255	321	Intens
124	255	321	Intens
155	255	334	GoboWh Rotate
300	45	131	GobWhin MSp Time
301	45		Intens
302	45		
303	45		
304	45		
305	45	250	Intens
306	45	251	Intens

Address 119 Park

1. Live Channel 2. Playback Status Display 3. Submasters 4. Patch 5. Park Channel

Parked channels Parked addresses

Chapter 19

Creating and Using Effects

Effects are a method within Ion to provide dynamic, repetitive action to channels. This chapter explains the different types of effects, and how to use them.

This chapter contains the following sections:

- **About Effects** 240
- **The Effect List** 240
- **Effect Status Display** 244
- **Step Effects** 245
- **Absolute Effects** 248
- **Multiple Intensity HTP Effects** 250
- **Relative Effects** 250
- **Program a New Relative Effect** 252
- **Apply an Existing Effect** 253
- **Effects on Submasters** 254
- **Delaying Effects** 255

About Effects

Effects are manual control functions that can be applied to a channel parameter and then included in cues or submasters. Cues can contain both standard transitions for some channels and parameters and effects for the same or other channels and parameters.

Intensities can have different effects running at the same time but they must be from different sources. You can have an intensity effect running on a cue and those same channels can be impacted by an intensity effect on a submaster. [See “Multiple Intensity HTP Effects” on page 250.](#)

Effects have user defined properties and attributes which are applied to the effects whenever they are used in cues. Effects also have cue level overrides, which allow you to use an effect in multiple locations, and modify its size, shape or rate in individual cues.

Within Ion, effects are broken up into three fundamental behavior types; Step, Absolute, and Relative effects.

The Effect List

At any time you may press **[Effect] [Effect]** to view the effect list. Any recorded effects will be displayed here. The effect list is a blind view and any changes made in this view are automatically stored; a record command is not required.

Notice that there are effects existing in this list prior to any being recorded. Effects 901-916 are preprogrammed relative effects that are automatically available to you (see [Relative Effects, page 250](#)).

To navigate this list use the navigation keys as described in [Display Control and Navigation, page 28](#) or select the effect number you wish to work with. Notice that when you select the effect list, the CIA changes to display the information for the currently selected effect.

Effect	Label	Type	Entry	Exit	Dur/Cyc	Scale
1	step based side lights	StepBased	Cascade	Immediate	Infinite	
2	Scroller Linear Effect	Linear	Immediate	Immediate	Infinite	16
3	Square	Focus	Immediate	Immediate	Infinite	29
4	Hue-Sat Fade	Color	Immediate	Immediate	Infinite	65
5	Absolute Mac 700 s	Absolute	N/A	N/A	Infinite	
6	int	StepBased	Cascade	Immediate	Infinite	
7	gobo chase	Linear	N/A	N/A	Infinite	37
8	movement	Focus	Immediate	Immediate	Infinite	78
9	color chase	Color	Immediate	Immediate	Infinite	48
10	Effect lead and drummer	Absolute	N/A	N/A	Infinite	
901	Circle	Focus	Immediate	Immediate	Infinite	25
902	Square	Focus	Immediate	Immediate	Infinite	25
903	Figure 8	Focus	Immediate	Immediate	Infinite	25
904	Can Can	Linear	Immediate	Immediate	Infinite	25
905	Triangle	Focus	Immediate	Immediate	Infinite	25
906	Spiral	Focus	Immediate	Immediate	Infinite	25

Effects Editor

When viewing the effect list, the selected effect is displayed in the CIA. The effect properties and attributes are shown in categorized buttons in the CIA. To change any property or attribute, press the corresponding button and enter data as required.

The properties display of the effects editor is shown below and definitions of properties follow.



Type

Defines the effect type: step-based, absolute, or relative (linear, focus, or color). To change the type, press **{Type}** and then press the desired effect type in the buttons to the left.

- **<Effect> [1] {Type} {Step based} [Enter]**

Scale

Applies only to relative effects. This modifies the amount the pattern is offset from the current parameter values. The scale is expressed as a percentage increase or decrease (25 = 25% of the programmed value).

- **{Scale} [3] [0] [Enter]** or you may adjust this using the "Scale" encoder.

Cycle Time

Provides a cumulative time to complete one full iteration of an effect. In relative effects, the cycle time determines the length of time required for one channel to complete the cycle.

In absolute and step-based effects, the cycle time determines the time required to complete one full iteration of the effect. In these effect types, modifying the cycle time changes the timing values proportionally within the effect itself.

To change the cycle time, press **{Cycle Time}** and then enter the desired time (in minutes and seconds) from the keypad, followed by **[Enter]**. This can also be adjusted from the encoder.

Duration/Cycle

This determines the length of time an effect will run. To specify, press **{Duration/Cycle}** and then choose the desired method from the buttons that appear to the left. The options are:

- **{Infinite}** - for step and absolute effects, the effect will run until the channel is provided a new instruction or the effect is stopped. Relative effects with an infinite duration will run until a stop flag is applied.
- **{Duration}** - the effect will run for a set amount of time given in minutes and seconds. Enter the time from the keypad.
- **{Num cycles}** - the effect will run for a set number of iterations. Enter the number using the keypad.
 - **{Duration/Cycles} {Num Cycles} [1] [0] [Enter]**

Parameters

This allows you to select which parameters will be involved in the selected effect, by default. By entering a value here, you do not need to specify the required parameter when placing an effect on a channel group.

To add or remove parameters to the effect, press **{Parameters}** and then select the desired parameters from the buttons that appear to the left.

- **{Parameters} {Iris} [Enter]**

Attributes

These determine the basic behavior of the effect. Attributes include behaviors such as forward, reverse, bounce, positive, negative, and random grouping or random rate. The attributes are slightly different between step, absolute and relative effects.

- **Forward** - the effect will run in the programmed direction (the arrow on the pattern editor indicates “forward” for pattern effects, step and absolute effects will follow numerical order).
- **Reverse** - effect will run in the opposite direction of forward or reverse numerical direction. Forward and Reverse are mutually exclusive settings.
- **Bounce** - effect will run first in forward, then in reverse. Subsequent passes alternate between forward and reverse.
- **Positive** - effect will run the steps (on state and off state) as programmed. This is applicable to step effects only.
- **Negative** - inverts the on state and off state for the effect. This is applicable to step effects only.
- **Random Grouping** - channel distribution or step order (depending on the type of effect) are applied in a continuously random fashion.
- **Random Rate** - this overrides the cycle time of the effect. Random Rate is applied in a range (for example 5- thru 150).

Play with these behaviors to see how they alter your effect.

Entry

Establishes at what time and how channels will enter the effect. To change the entry method press **{Entry}** and then choose a method from the buttons to the left. Entry modes vary by effect type. The options are:

- **{Cascade}** - channels enter the effect according to the trail and cycle time values (if applicable).
- **{Immediate}** - all channels enter the effect instantaneously.
- **{Fade by Size}** - the effect will achieve its full value as allowed by the pattern or step or absolute values using the In Time.
- **{Fade by Rate}** - increases the rate of the effect as it enters. If an effect submaster has an entry mode of **{Fade by Rate}**, the submaster will control the rate between 0 to 100.
- **{Fade by Size and Rate}** - the effect will achieve its full value as allowed by the pattern or step or absolute values and ramp up to full speed using the In Time.

Exit

Establishes at what time and how channels will exit the effect. To change the exit method press **{Exit}** and then choose a method from the buttons to the left. Exit modes vary by effect type and how the effect is stopped. The options are:

- **{Cascade}** - channels leave the effect when they have completed their last pass (number of cycles) or when they do not have enough time to make a final complete pass (duration).
- **{Immediate}** - all channels exit the effect instantaneously.
- **{Fade by Size}** - when the effect is exited, values will return to their background state while

still running using the exit time.

- **{Fade by Rate}** - decreases the rate of the effect as it exits.
- **{Fade by Size and Rate}** - when the effected is exited, channels will stop running the effect and return to their background state using the exit time.
- **{Stop and Fade}** - when the effected is exited, channels will stop running the effect and return to their background state using the exit time.
- **{Stop and Hold}** - when the effect is existed, channels will halt exactly where the effect left them.

Time (Entry or Exit)

These fields establish the length of time for channels to enter or exit the effect. It can be entered in minutes and seconds from the keypad. These timing values are applied to the entry and exit modes. Cue level timing is the default for these. Press **{Entry Time} [Enter]** or **{Exit Time} [Enter]**. To reset to defaults, press **[Time] [Enter]**

Grouping

Grouping is used only in relative and absolute effects. This determines how channels currently running the effect will be grouped throughout the pattern. To change this press **{Grouping}** and then enter the number of lights you want grouped together.

Grouping defaults to **{Spread}**. This means that every light the effect is applied to will act as an individual element, moving through the effect sequentially based on the channel selection order, cycle time, and trail times. You can enter any number you require. A grouping of 2 means that every other light in the selection list when the effect is applied will move together through the effect. Grouping of three means every third light, and so on.

Your options are 1-29 or **{Spread}** which will distribute each channel in the effect evenly and treat it as a separate group.

- **{Grouping} [2]** - every other channel (in a range of channels) will be grouped when running the effect.

When an effect is applied to a group in live, that group is distributed by order, using this grouping function. If a group list is created and an effect applied, each group is considered an individual element within the effect.

Trail

Trail is applicable to relative and absolute effects. Trail determines how channels are to follow each other through the effect; it is a percentage of the cycle time. Trail can be any value from 0-100%, even, or solo. The default is even. For example:

- **{Even}** - the groups will be distributed evenly throughout the pattern. This is calculated by dividing the cycle time of the effect by the number of groups of channels.
- **{10%}-{90%}** - when the first group is 10% through the effect, the second group will start the effect, and so on through the remaining groups. Therefore, the groups will trail n% behind each other, as a percentage of the cycle time.
- **{Solo}** - the first group will execute the entire pattern. When done, the second group will execute the entire pattern, and so on.

Using Encoders with the Effect Editor

When any effect is specified in the command line, the encoder LCD automatically repaints to display the following properties:

- Cycle Time (Default is 5 seconds for relative effects)
- Scale
- Shape (Vertical or Horizontal as defined by the {Mode} button)
- Axis

At any time, you may use the encoders to adjust these properties within the effects editor for the specified effect.

Effect Status Display

To view the effects currently running, you may press **[Displays]>{Effect Status}** to reveal the effect status display in the CIA.

This display shows you any currently running effects and gives you the ability to edit the effect while running. When an effect is selected, the encoders and encoder screen change to allow you to manipulate the effect according to rate, size, horizontal form, vertical form, and axis.

For Example:

To edit an effect, select the effect using the command line or by clicking on the effect in the status display.

- **[Effect] [9] [0] [2] [Enter]**

The encoder screen repaints so that the encoders now control the five attributes in the columns of the effect status display:

- Rate - modifies cycle time. Default is 100% and can be modified from 0%-2000%.
- Size - modifies scale. Default is 100% and can be modified from 0%-2000%.
- Shape (Vertical or Horizontal as defined by the **{Mode}** button) - default is 100% and can be modified from 0%-2000%.
- Axis - default is 0° and can be modified by +/- 180°.

Use the encoders or softkeys to adjust the effects while watching the effect on stage.

Effect	Source	Channels	Delay	Rate	Size	H. Form	V. Form	Axis
1		26 36 46 27 37 47 28 38 48 29 39 49 30 40 50 31 41 51		100				
5	Man	71>73		100				
7*	Man	61>64	10	100	100			
902*	Man	81>86		175	65	150	25	-153

The effect itself can be accessed for editing from this display by pressing **{Edit}**. Any changes made directly in the effect status display are made to the effect itself and must be stored. Cue level overrides also must be stored or updated to the required cue, but do not impact the basic effect itself.

Effect attributes modified in the effect status display can be reset to their previous values using the softkeys:

- **{Rate} [Enter]** - resets the rate to the previous value.

Step Effects

In step effects, each step contains an on-state and an off-state. The on-state is the action the channels in the step should take when the step is active. The off-state is the action the channels in the step should take when the step is not active. Step effects are a quick and easy way to build simple chases.

When building step effects, channels must be defined for each step. This is different from absolute and relative effects.

Once complete, you may play back the effect on all channels embedded in it by pressing **[Recall From] [Effect] [x] [Enter]**. Or you may specify only certain channels to play back from the embedded channel list.

A step effect is displayed in a chart with the following columns:

- **Step** - indicates the step numbers.
- **Channels** - displays the channel(s) in the step.
- **Param** - displays the parameter (if other than intensity) controlled by the step.
- **Step Time** - time from triggering the associated step to triggering the next step.
- **In Time** - the length of time for the channels to fade to the “on-state”.
- **Dwell Time** - the length of time the step remains in an “on-state”.
- **Decay Time** - the length of time it takes for the channels to fade to the “off-state”.
- **On State** - the parameter level (in%), or referenced data to be used for the on-state.
- **Off State** - the parameter level (in%) or referenced data to be used for the steps off-state. If you want the “off-state” to be the background state from playback, select the column and press [At] [Enter].

All times are entered from the keypad in minutes and seconds, tenths and hundredths.

Here is an example of a step effect when viewed in the CIA:

Step	Channels	Param	Step Time	In Time	Dwell Time	Decay Time	On State	Off State
1	26 36 46		0.3	0.3	0.3	0.3	100	0
2	27 37 47		0.3	0.3	0.3	0.3	100	0
3	28 38 48		0.3	0.3	0.3	0.3	100	0
4	29 39 49		0.3	0.3	0.3	0.3	100	0
5	30 40 50		0.3	0.3	0.3	0.3	100	0
6	31 41 51		0.3	0.3	0.3	0.3	100	0

Effect 1 :step based side lights

Type StepBased	Scale N/A	Entry Cascade Fade by Size	Exit Fade by Size
Cycle Time 1.8	Duration/Cycle Infinite		
Parameters	Attributes Forward Positive	Time 0	Time 0

Step In Time On/Off InsrBefore Move To Properties

Step effect softkeys

Program a Step Effect

Below is the process used to program the effect illustrated in the image above.

For Example:

To open the effects list press:

- **[Effect] [Effect]**

Establish the number of the effect by pressing:

- **<Effect> [1] [Enter]**

The CIA will repaint with unpopulated fields for the new effect. Assign the effect as “step” by pressing:

- **<Type> {StepBased}**

The effect will appear in the list and the CIA will repaint with the default entries for the effect and a step chart for the effect. Define the number of steps by pressing:

- **{Step} [1] [Thru] [6]**

The steps will populate the chart and will remain selected. To make identical changes to all steps at once, you may now use the page arrow keys to navigate the chart. To make changes to only a single step, specify only one step in the command line, default values are drawn from the previous step.

After paging to the “Channels” column, specify the channels for the effect.

- **[1] [Thru] [1] [2] [Enter]**

Channels 1-12 will be broken up and distributed through the steps in the chart. Choose the parameter you would like in the effect by pressing:

- **{Parameters} <Intensity> (Intensity is assumed unless another parameter is specified)**

All steps are now intensity based. Use the page arrows to access the “Step time” column. Enter the desired step time:

- **[1]**

Page arrow to the Dwell Time (In time is left at 0) column and enter a dwell time:

- **[1]**

Page arrow to the Decay Time column and enter a decay time:

- **[.] [2] [5]**

Page arrow to the On State column and enter the on state percentage:

- **[1] [0] [0]**

Page arrow to the Off State column, or use the softkeys to go to the desired field, and enter the off state percentage:

- **[5]**

Adjust any of the effect details on the right side of the CIA by pressing the appropriate detail button and making changes (see [Effects Editor, page 241](#)).



Note:

The cycle time is an aggregate of all of the timing in the effect and indicates how long it will take to make one full pass through the effect. If the cycle time is modified by the keypad or the encoder, it proportionally adjusts all of the timing within the effect.

Delete a step

To delete a step from a step-based effect, specify the effect in the command line and press delete:

- **[Effect] [1] {Step} [4] [Delete] [Enter] [Enter]**
- **[Effect] [1] {Step} [4] [Thru] [8] [Delete] [Enter] [Enter]**

Insert a step

To insert a step anywhere in the effect, specify the step you wish the new step to be inserted before.

- **[Effect] [1] {Step} [4] {Insert} [Enter]** - Inserts a new step before step 4. If step four does not exist, it also creates the steps necessary to have “step 4” and then places a step ahead of it as well.

Inserted steps result in all succeeding steps to be bumped one place lower in the effect. In the above example, by inserting before step 4, step 4 would become step 5, step 5 would become 6 and so on. The inserted step would become the new step 4.

Absolute Effects

Absolute effects are a listing of sequential actions that channels are to take. They differ from step effects in that there is no on/off state, rather they define progressive behavior from one action, to the next, to the next, and so on. The best example of this is that palettes and presets can be used as actions in absolute effects.

Absolute effects differ from relative effects (which are also progressive) in that you are specifying exactly what actions you want the lights to take, rather than mathematical offsets from the current state (relative effects).

Absolute effects also do not contain an embedded channel list. Therefore, the effect must be applied to channels in order to be played back.

Absolute effects are displayed in a chart with the following columns:

- Action - displays the action number.
- Time - the time for the action to fade in.
- Dwell - the duration of the action before moving to the next action.
- Level - indicates either the level of the parameter specified in the effect, or the referenced value for the channel(s) to perform (Palette or preset as defined in the command line).

Action	Time	Dwell	Level
1	1	0	FP 1
2	1	0	IP 9
3	1	0	CP 1
4	1	0	CP 2
5	1	0	CP 3
6	1	0	CP 4
7	1	0	FP 4
8	1	0	CP 1

Effect 10 :Effect lead and drummer

Type: Absolute, Scale: II/A, Cycle Time: 11, Duration/Cycle: Infinite, Parameters: (empty), Attributes: Forward, Entry: Fade by Size, Exit: Fade by Size, Time: 0, Grouping: 1, Trail: Even

Move To: Action, Time, Dwell, InsrBefore, Properties

Absolute effect softkeys

In the above image, actions 1-8 indicate referenced values in the “Level” column (palettes or presets), though these values can be absolute data as well.

Program an Absolute Effect

Below is the process used to program the effect illustrated in the image above.

For Example:

To open the effects list press:

- **[Effect] [Effect]**

Establish the number of the effect by pressing:

- **[Effect] [8] [Enter]**

The CIA will repaint with unpopulated fields for the new effect. Assign the effect as absolute by pressing:

- **<Type> {Absolute}**

The effect will appear in the list and the CIA will repaint with the default entries for the effect and an action chart for the effect. Define the first action by pressing:

- **{Action} [1] [Enter]**

The step will populate the chart and will remain selected. You can also create a range of actions at once, using the **[Thru]** button, if desired. Use the page keys to navigate to the different columns

After arrowing to the "Time" column (or using the softkeys), specify the fade in time for the actions.

- **[5] [Enter]**

Page arrow to the Dwell column and enter a dwell time:

- **[5] [Enter]**

Page arrow to the Level column and enter the desired referenced target:

- **[Color Palette] [5]**

Page arrow down and a new action will be created. All fields default to the values in the previous action. Page to the next action in the Level column and enter the referenced target:

- **{Color Palette 8}**

Page arrow down to the next action in the Level column and enter the referenced target:

- **[Color Palette] [2]**

Page arrow down to the next action in the Level column and enter the referenced target:

- **{Color Palette 4}**

Adjust any of the effect details on the right side of the CIA by pressing the appropriate detail button and making changes (see [Effects Editor, page 241](#)).

Multiple Intensity HTP Effects

Multiple intensity HTP effects are either step or absolute effects running on HTP submasters or cue lists. For multiple intensity HTP effects to run correctly, they must be recorded and played back from different sources.

For example, you create three separate step effects. Each effect impacts the same channels. For the three separate effects to run correctly you need to record them to three separate effect submasters or cues in separate cue lists. Either method will allow for each effect to run together according to the rules of HTP. But, for example, if you were to have three separate effects running on three separate effects submasters and you try to record that into one cue, the cue will only run the effects that were currently at the highest level at the moment of the record.

Relative Effects

A relative effect is an offset from the current state of a channel parameter. There are three different types of relative effects: focus, color, and linear. Each of these effect types have a graphic editor designed specifically for the parameters involved.

Relative effects have many of the same properties and attributes as step-based and absolute effects.

Ion is preprogrammed with 16 relative effects which represent some of the most commonly used patterns and parameters. These are automatically visible in the effects list and can be manipulated using the encoders to conform to your needs. You may also custom build relative effects.



Note:

As you learn to use the effects editor with relative effects, it is recommended that you experiment with the preprogrammed effects until you understand the fundamentals and how effects can be altered.

Focus Effects

Focus effects are designed to impact a channel's pan and tilt parameters. These are represented in the horizontal and vertical axes of the graph in the effects editor. They can be created from live or blind and the properties can be set in the effects editor as any other effect (see [Effects Editor, page 241](#)).

New focus effects default to a circle. You can clear this and draw your own shape by pressing **{Edit}>{Clear}** and drawing on the graph with your finger or the mouse. Press **{Apply}** when you are done. Canned focus effects can be modified in the same manner. The green arrow indicates default direction of motion, which can be modified in attributes.

Focus Effect

Type	Scale	Entry	Exit
Focus	37	Cascade	Fade by Size
Cycle Time	Duration/Cycle	Fade by Size	
5.47	Infinite		
Parameters	Attributes	Time	Time
Pan	Forward	1	1
Tilt			
Grouping	Trail		
Spread	Solo		

Edit

Color Effects

Color effects impact only color parameters. Hue and saturation offsets can be used which are represented in the horizontal and vertical axes of the graph in the effects editor. The **{Parameters}** key within a color effect displays the various color mechanisms used in any patched channels.

New color effects default to a circle. You can clear this and draw your own shape by pressing **{Edit}>{Clear}** and drawing on the graph with your finger or the mouse. Press **{Apply}** when you are done. Canned color effects can be modified in the same manner. The green arrow indicates default direction of color shift, which can be modified in attributes.

Color Effect

The screenshot shows the 'Effect 914: Hue-Sat Fade' editor. On the left is a graph with a grid. The vertical axis is labeled 'HUE' and the horizontal axis is labeled 'SATURATION'. A blue circle is drawn on the grid, with a green arrow pointing to the right along the SATURATION axis. Below the graph is an 'Edit' button. On the right is a control panel with the following settings:

Category	Value
Type	Color
Scale	25
Cycle Time	4.86
Duration/Cycle	Infinite
Parameters	Hue, Sat
Attributes	Forward
Entry	Cascade, Fade by Size
Exit	Fade by Size
Time (Entry)	1
Time (Exit)	1
Grouping	Spread
Trail	Even

Linear Effects

A linear effect does not have to be parameter specific. Rather it can simply be a reference to a linear diagram which can be applied to any parameter. You can redraw the linear diagram for an existing linear effect by pressing **{Edit}>{Clear}** and then tracing the diagram on the graph with the mouse or your finger. Press **{Apply}** when you are done.

Linear Effect

The screenshot shows the 'Effect 904: Can Can' editor. On the left is a graph with a grid. The vertical axis is labeled 'TILT' and the horizontal axis is labeled 'TIME'. A blue trapezoidal shape is drawn on the grid, with a green arrow pointing to the right along the TIME axis. Below the graph is an 'Edit' button. On the right is a control panel with the following settings:

Category	Value
Type	Linear
Scale	25
Cycle Time	4.86
Duration/Cycle	Infinite
Parameters	Tilt
Attributes	Forward
Entry	Cascade, Fade by Size
Exit	Fade by Size
Time (Entry)	1
Time (Exit)	1
Grouping	Spread
Trail	Even

Define a Pattern Shape

Shapes can be defined for any relative effect (focus, color, or linear).

To define a shape, press the **{Edit}** softkey beneath the pattern editor. The softkeys will change to **{Apply}**, **{Restore}**, **{Clear}**.

- Press **{Clear}** to clear the pattern.
- Draw a new pattern using your finger (or the mouse). If you want to return to the original pattern, press **{Restore}** *before pressing apply*.
- When you have the proper pattern drawn, press **{Apply}**. The pattern will be applied to the effect.



Note:

If you delete a preprogrammed effect (for example, after making changes to it) the effect will return to its default value.

You can also copy effects to another effect location and modify them from there. This will leave the original effect untouched.

- **[Effect] [904] [Copy To] [8] [Enter]**
-

Program a New Relative Effect

To open the effects list press:

- **[Effect] [Effect]**

Establish the number of the effect by pressing:

- **[Effect] [4] {Type} {Linear/Focus/Color} [Enter]**

The effect will appear in the effect list and the CIA will repaint with the effect details visible. Manipulate the effect using the encoders, effect graph, or property fields so that the effect meets your needs (see [Effects Editor, page 241](#) for details on effect properties and encoders).

Apply an Existing Effect

Once an effect has been created, it will appear in the effects list. To apply an existing effect, press:

- [Select Channels] [Effect] [x] [Enter]
or using the direct selects
- [Select Channels] {Effect x}

The selected channels will begin their changes as programmed in the effect.

Since step based effects have an embedded channel list, those effects can be recalled by [Group] [Effect] [n] [Enter] or [Recall From] [Effect] [n] [Enter] without selecting channels.

Recording an Effect in a Cue

To apply an existing effect, press:

- [Select Channels] [Effect] [x] [Enter]

Recording to a cue, press:

- [Record] [Cue] [x] [Enter]

Editing Effects Live

To edit an effect while it is running, press:

- [Displays] {Effect Status}

The effect status display will open in the CIA and any currently running effects will be visible in the display. Selecting the effect number in the status display will select the effect for editing. Select the effect you want to edit live by pressing:

- [Effect] [x] [Enter]

Use the encoders to adjust the attributes as described in [Effect Status Display, page 244](#). Adjustments are cue overrides and don't impact the core effect.

To edit other properties of the effect in live, press {Edit} and the effects editor will open (See [Effects Editor, page 241](#)). Changes made in the editor will impact the effect itself and all instances in which the effect is used. Changes made to effects in the effect status display impact only that instance of the effect. Changes made directly in the effect editor impact all instances of that effect. The changes will then need to be recorded or updated.

Stop an Effect

Pressing [Fader Control] {Stop Effect} [Enter] will stop all running effects.

To stop a specific effect, press: [Effect] [n] [At] [Enter]

You may also stop effects on specific channels by [selecting channels] [Effect] [Enter].

You may also remove an effect instruction by [selecting channels] [Effect] [At] [Enter]. This command will work in live or blind. You can also stop the whole effect by pressing [Effect] [x] [At] [Enter].

Deleting an Effect

To delete an effect, press [Delete] [Effect] [n] [Enter] [Enter]. If you delete one of the default effects (901 through 916) that effect will return to its default values.

Effects on Submasters

Channels running effects can be loaded onto a submaster. Pressing the bump button of the submaster starts or stops the effect.

For the submaster to control the rate and/or size of the effect, it must be configured as an effects submaster. When a submaster is defined as effect, only the effect information is stored. The slider will then have control of the in and out behavior of the effect.

If the submaster is set to additive, the slider will control non-effect values only.

Configuring an Effect Submaster

To configure an effect submaster, press:

- [Sub] [x] {Mode} [Enter]



Note: *The {Mode} softkey toggles between inhibitive, effectsub, and additive. Press {Mode} until effectsub is on the command line.*

Recording an Effect to a Submaster

To apply an existing effect, press:

- [Select Channels] [Effect] [x] [Enter]

Recording to a submaster, press:

- [Record] [Sub] [x] [Enter]

Running an Effect from a Submaster

The way effects are played back from a submaster depends on its mode, and whether the submaster is set to be a proportional fader or an intensity master.

Below is an example of four different submasters, in different modes, with the same effect stored to them.

Effect on an Additive/Proportional Submaster

The submaster contains the intensity, pan/tilt data, along with the effect. Pressing the bump button starts the effect. The fader controls values not affected by the effect. Pressing the bump button again stops the effect.

Effect on an Additive/Intensity Master Submaster

Pressing the bump button marks the lights, and starts the effect. The fader brings up any intensities stored in the submaster. Pressing the bump button again stops the effect.

Effect on an Effect/Proportional Submaster

Pressing the bump button starts the effect. The fader controls the rate and/or size based on the effect's entry behavior. Pressing the bump button again stops the effect.

Effect on an Effect/Intensity Master Submaster

Pressing the bump button starts the effect. The fader controls the rate and/or size based on the effect's entry behavior. Pressing the bump button again stops the effect.

In other words, there is no difference between a proportional fader and an intensity master when the submaster is configured to be an effect submaster.

Delaying Effects

A delay can be placed on an effect in a cue or submaster by using the syntax **[Effect] [n] [Delay] [n] [Enter]**. **[Effect] [n] [Delay] [Enter]** removes the delay.



Note: *If an effect delay is set in live, the cue or submaster must be recorded to include the delay.*

The Effect Status display has a delay column to show when a delay has been applied to an effect. When an effect is in delay mode, the column will display the countdown for the delay.

Effect	Source	Channels	Delay	Rate	Size	H. Form	V. Form	Axis
1		26 36 46 27 37 47 28 38 48 29 39 49 30 40 50 31 41 51		100				
5	Man	71>73		100				
7*	Man	61>64	10	100	100			
902*	Man	81>86		175	65	150	25	-153

When an effect is delayed, a "*" will display by the effect number in the playback status display external links column.

www.carlosmendoza.com.mx

Chapter 20

Storing and Using Submasters

Faders, both virtual and physical, can be assigned as submasters. This chapter explains how to assign and use submasters on your Ion console. You may also use submasters with Universal Fader Wings. For more information on these, see [Universal Fader Wings, page 389](#).

This chapter contains the following sections:

- [About Submasters](#) 258
- [Changing Fader Pages](#) 262
- [Loading Submasters](#) 263
- [Using Bump Button Timing With Submasters](#) 265
- [Submaster List](#) 266

About Submasters

Submasters can store any parameter data for channels. When storing from Live, Record Only and Record can both be used to determine what contents are stored. You can copy cues, presets, or palettes to a submaster as well. Channels running effects can be loaded onto a submaster. See [“Effects on Submasters” on page 254](#). Submasters can be accessed using the slider module (see [Slider Module, page 220](#)) or the Universal Fader Wings (see [Universal Fader Wings, page 389](#)).

Faders can be configured as submasters in setup (see [Fader Configuration, page 98](#)) or they can be defined while programming.

In blind, submasters can be created by using the **[Thru] [Thru]** syntax.

- **[Sub] [1] [Thru] [Thru] [1] [0] [Enter]** - will create subs 1 through 10.

To automatically set the submasters to 1-to-1, in blind, press **[Sub] [1] [Thru] [Thru] [3][0][0] [Enter]** to create all 300 submasters. Now in Live, press **[Sub] [1] [Thru] [Enter]**, which selects all submasters created. Then you can hit the load button for the first submaster and it will load all submasters sequentially.

When set as a submaster, the bottom button beneath the potentiometer acts as a bump button or a mark button depending on the submaster type (Proportional or Intensity Master). The button above the bump can be used to select all of the channels associated with the submaster, if the submaster is inactive. This is equivalent to the syntax **[Group] [Sub] [x] [Enter]**. When the submaster is active, this button will assert the contents of the submaster when pressed.

It is possible to program upfade, dwell, and downfade times in association with the submaster bumps.

On fader wings, when a submaster bump LED is blinking, it means that the submaster must be homed due to either changes to its content or to its mode. In either case, reset the submaster by dropping it to zero and the moving it back to the desired position. Inhibitive submasters (see below) that are blinking must be homed to 100% rather than zero. The LED will also blink when the submaster is in a “Held” state via bump button timing

Recording a Submaster

You can record current stage contents directly to a submaster. To do this, set levels in live as needed then record them to the submaster. See the following examples:

- **[Record] [Sub] [5] [Enter]** - records all current values to sub 5.
- **[Record Only] [Sub] [5] [Enter]** - records the manual values of the current stage state to sub 5.
- **[Record Only] [Sub] [5] [Label] [xxxx] [Enter]** - as above, with a label.
- **[Record] [Sub] [5] {Mode} [Enter]** - as above, and alters mode between inhibitive or additive. Other submaster properties (HTP/LTP, Exclusive, and so on) can be assigned in this way as well.

You can also record selected channel data to submasters as well. See below:

- **[Channel List] [Record] [Sub] [5] [Enter]** - records all data for the channel list to sub 5.
- **[Channel List] [Record Only] [Sub] [5] [Enter]** - records manual data for the channel list to sub 5.

Submasters can also be recorded using selective storing, which allows you to specify only the channels that you want stored.

- **[6] [Thru] [1][0] [Record] [Sub] [3] [Enter]** - records only channels 6 through 10 to submaster 3.

If a submaster already has data stored to it, selective store will act as a merge function. Using the above example of channels 6 through 10 stored to submaster 3, if you were to then store channel 5 to submaster 3, that would be added to the current content so that channels 5 through 10 are now stored.

If you don't want the data to merge, you can either first delete the submaster to remove the original content. See [“Deleting a Submaster” on page 264](#). Or you can selective store while using **[Rem Dim]**.

- **[5] Record] [Sub] [3] [Rem Dim] [Enter]** - records channel 5 to submaster 3 and removes any previous data from the submaster.

Submaster Displays

In the display window of any programmed submaster, you will see the following:

- Submaster number
- Submaster label (if any)
- Independent flag (if any)
- I-Master flag (I.M. - if any)
- Current submaster value

Additive, Inhibitive, or Effectsub

You may define your submaster as additive (contributes to the live output) or inhibitive (limits live output). Ion defaults to submasters being additive.

To toggle a submaster between additive, inhibitive, or effectsub:

- **[Sub] [7] {Mode} [Enter]**

Additive submasters are indicated by a green LED or a green outlined fader icon in the fader window.

Inhibitive submasters display these indicators in red. Channels mastered by an inhibitive submaster are indicated with an “I” next to the intensity value in the channel display in live. Inhibitive submasters do not provide levels to the stage picture, they limit them (similar to a grandmaster). It is possible to put non-intensity parameters onto an inhibitive submaster, but it must be done from blind.

For more information about effectsub, See [“Effects on Submasters” on page 254](#).

Proportional vs. Intensity Master

A submaster can be set to be either a proportional fader or an intensity master. This is done using the **{Fader}** softkey. Ion defaults to submasters as proportional.

Proportional submasters

When a submaster is proportional, the slider will control all contents of the submaster (intensity and non-intensity parameters) when moved from zero. When a proportional sub is return toward zero, channel will be returned to their previous level.

The bump button can be used to bump all values to their recorded levels in the submaster, or, by assigning timing values, fade the contents of the submaster up or out.

Intensity master

When set to this fader type, the slider will control intensity only. The bump button can be used to preset (mark) non-intensity parameters stored to the submaster. If the bump is not pressed before the slider is moved, the slider will also fade the non-intensity-parameters to their recorded values. Once the non-intensity-parameters are at their end state, the slider only controls intensity. When dropped toward zero, controlled intensities will be faded toward zero.

When non-intensity parameters on a intensity master submaster have been marked using the bump button, the LED on its bump button will pulse to tell you that the non-intensity parameters have been marked.

Pressing the bump button for an intensity master submaster that is currently bumped will release the non-intensity parameters using the bump button timing. Its bump button LED will also be turned off.

To toggle a submaster between a “Proportional” or “I-Master” fader:

- **[Sub] [8] {Fader} [Enter]**

HTP vs. LTP

Submasters can be set to be either Highest-Takes-Precedence (HTP) or Latest-Takes-Precedence (LTP). This setting is applied to intensity only. Non-intensity parameters are always LTP. Ion defaults all submasters to HTP. For more information on HTP and LTP see [HTP vs. LTP, page 7](#).

To toggle a submaster between HTP and LTP:

- **[Sub] [6] {HTP/LTP} [Enter]**

Exclusive Submasters

Submasters can be placed in exclusive mode. This prohibits storing the contribution of the submaster into any record targets. In essence, this acts as a fixed **[-] [Sub] [Record]** command.

To place a submaster in exclusive mode:

- **[Sub] [5] {Exclusive} [Enter]**

Priority

A submaster can be set to be independent, shielded, or no priority. This is done using the **{Priority}** softkey. Ion defaults to submasters as no priority.

Independent

You can also set a submaster to “independent”, allowing submaster values to remain unaffected by other submasters or playback fader instructions. They will, however, still be impacted by manual control, grandmaster, blackout, park instructions, or other play faders and submasters on independent.



Note:

Inhibitive submasters cannot be set as independent.

Shield

The content of a shielded submaster is automatically made exclusive and can't be controlled by anything other than that submaster and park, including by manual control.

Channels stored to shielded submasters will display in yellow with a superscript 's' beside it.

If channel parameters stored to shielded submasters were previously stored to cues or other submasters, those instructions will be ignored on playback.

If the same channels are assigned to more than one shielded submaster, control of those channels will be shared on either a LTP or HTP basis depending on the settings for the submasters.



Note: *Inhibitive submasters cannot be shielded.*

To toggle a submaster between priority options:

- **[Sub] [7] {Priority} [Enter]**

Restore

Submasters can be placed into restore modes of minimum or previous, which is the default. When a submaster is in the restore to previous mode, the restore column of the submaster list display will be blank. When in minimum mode, 'Min' will display in the restore column.

The restore mode of previous means that when the submaster is returned to zero, control will be restored to the background value, such as another submaster or a cue.

The restore mode of minimum means that when the submaster is faded down, control does not go to the previous background state but to the parameters' minimum value.

To toggle the restore mode between "Previous" and "Min":

- **[Sub] [8] {Restore} [Enter]**

Submaster Background State

Submasters can have their background states disabled. Background states are enabled by default. When enabled, the content of the submaster will act as a background or previous state for other cues and submasters. When a submaster has its background state disabled, a "D" will be displayed in the Submaster List background column.

For example, cue 1 has channel 10 at 25%. Submaster 1 is raised and has channel 10 at 50%. Submaster 2 is then brought up and has channel 10 at Full. When submaster 2 is lowered to zero, control will be returned to submaster 1. If submaster 1 is lowered to zero, control will return to cue 1.

Using the above example, if submaster 1 has its background state disabled, which makes its content unavailable as a background state, then when submaster 2 is lowered to zero, control would return to cue 1 and not to submaster 1.

To disable a submaster's background state:

- **[Sub] [9] {Background} [Enter]**

Changing Fader Pages

On Fader Wings

The fader wing is paged using the **[Fader Controls]** button on the Ion console. Fader pages are delineated in 10 fader increments. If you advance to the next fader page, your entire fader wing array will advance by a total of 10 faders.



Note: *On a 2x10 fader wing, you can only access the first 19 pages of faders.*

To change the fader page of a fader wing:

- Step 1: Press and hold the **[Fader Controls]** button on the Ion console. The LCD on the fader wing will display the available pages beneath the fader bump buttons.
- Step 2: Press the bump button corresponding to the page you wish to display on the fader wing. The fader wing will display those faders after your selection is made.

On the Slider Module

The slider module is paged on Ion using the page buttons that are displayed to the right of the module. There are 30 available pages of sliders. Pages are delineated in 10 fader increments. Click on the appropriate page button to access that row of sliders. You can scroll through the available pages by clicking the arrow button(s) next to the page buttons.

Loading Submasters

Submasters can be loaded with cues, presets, or palettes. You can convert an empty fader to a submaster without configuring it in setup. Any fader can be configured and loaded with a submaster if:

- the fader is not configured
- or-
- the fader is configured as a playback but has no cue list loaded to it
- or-
- the fader is configured as a submaster, but that submaster is empty.

Regardless of the fader configuration in setup, if the above conditions are met, the fader can be loaded with the submaster specified on the command line.

If a submaster with data (or a playback fader) already occupies the fader, that fader must be unloaded before another submaster can be loaded.

To release a fader that contains a submaster:

- Step 1: Press and hold **[Fader Controls]**.
- Step 2: If necessary, select the fader page that contains the desired fader. Pressing the appropriate **page bump button** on the fader wing or use the page controls with the slider module.
- Step 3: Press **{Release}**.
- Step 4: Press both buttons (**[Load]**) of the desired fader. The fader will be released but will remain configured as a submaster

On Fader Wings

Faders on fader wings can be configured as submasters by pressing both buttons of the desired fader. In this instance, this acts as a **[Load]** button.

To load a fader with a submaster:

- Step 1: Specify the submaster on the command line.
 - **[Sub] [5] [Enter]**
- Step 2: Press both buttons (**[Load]**) for the desired fader. The submaster will load to the fader.

On the Slider Module

- **[Sub] [5] {Load}** - loads submaster 5 to the fader associated with the load button.
- **[Cue] [5] [Sub] [4] [Enter]** - loads the contents of cue 5 to submaster 4 (a **{CopyTo}** command will appear within the syntax on the command line).
- **[Cue] [5] {Load}** - loads cue 5 to the submaster associated with the chosen load button.
- **[-] [5] [Cue] [5] [Sub] [6] [Enter]** - loads the contents of cue 5, minus channel 5, to submaster 6.
- **[Cue] [1] [Thru] [5] [Sub] [1] [Thru] [4] [+] [7]** - sequentially loads cues 1 thru 5 to subs 1, 2, 3, 4 and 7.
- **[Cue] [1] [Thru] [5] [Sub] [1] [Thru] [Enter]** - sequentially loads cues 1 thru 5 to subs 1 thru 5 (a **{CopyTo}** command will appear within the syntax on the command line).

Updating a Submaster

It is possible to make changes to a submaster in live mode. **[Update]** is used to store changes to a submaster.

- **[Update] [Sub] [5] [Enter]** - updates sub 5 to include changes in live output only for channels already in submaster 5. You can also press the bump button for submaster 5 to select it.
- **[Channel list] [Update] [Sub] [5] [Enter]** - adds only the specified channels to submaster 5.

Labels can be changed without restoring the contents as well:

- **[Sub] [6] [Label] [xxxx] [Enter]**
- **[Sub] [6] [Label] [Label] [Enter]** - removes the label.

Releasing Content From a Submaster

To release content from a submaster, use one of the following methods:

- **[Fader Control] {Off} & [Load]**- stops any running effects and fades out according to the **{Restore}** mode of the submaster.
- **[Fader Control] {Release} & [Load]** - behaves in the same way as **{Off}**. **{Release}** does not unmap the fader.
- **[Shift] & [Load]** - behaves like **{Off}** and **{Release}** except that it will also unmap the fader.

Deleting a Submaster

You can delete a submaster using the **[Delete]** key. When a submaster is deleted, the slider remains configured as a submaster, but it will be empty.

- **[Delete] [Sub] [5] [Enter] [Enter]** - deletes the contents of sub 5.

Using Bump Button Timing With Submasters

Each submaster bump can have three different timing values: Upfade, Dwell, and Downfade (see below). The default timing is set so that the bump functions as an “on” flash key for additive submasters and an “off” flash key for inhibitive submasters. Effects on submasters will follow submaster timing, unless timing has been placed in the effect itself

The three timing values are:

- **Upfade time** - this is the time for the submaster to fade from its home position to its target position (0 to Full if additive, Full to 0 if inhibitive). The default time is 0.
- **Dwell time** - this is the time the submaster look will hold before starting the downfade. This can be set to a specified time, or to “Hold” or “Manual”. “Hold” time maintains the submaster values until the bump is pressed a second time. “Manual” time applies the submaster values only as long as the bump is held. The default is “Manual”.
- **Downfade time** - this is the time for the submaster to fade from its target position to its home position. The default time is 0.

At any time, the potentiometer can be used to manually override fade progression or a submaster triggered with time.

To add bump button timing live:

- **[Sub] [8] [Time] [3] [Time] [4] [Time] [3] [Enter]** - adds a 3 second upfade, 4 second dwell and 3 second downfade to submaster 8.
- **[Sub] [2] [Time] [Time] {Manual} [Time] [3] [Enter]** - adds a manual dwell time and a 3 second downfade time to submaster 2. When the bump is pressed and held, it will flash on and stay on until the button is released, at which time it will begin the downfade.
- **[Sub] [4] [Time] [3] [Time] {Hold} [Enter]** - adds a 3 second upfade time, and a ‘hold’ dwell time. When the bump is pressed, the upfade starts. Once at the target value it will remain there until the button is pressed again. The downfade will “bump” to zero.
- **[Sub] [3] [Time] [Enter]** - resets all time for submaster 3 to default (Up = 0, Dwell = Manual, Down = 0).

Controlling Subfades Manually

It is possible to take control of submasters even if they have recorded time. To capture the fade you must push the potentiometer past the current fade level. Once this is done, control is transferred to the potentiometer for full manual control.

You may then use the potentiometer to increase or decrease the submaster level as needed.

Submaster List

You can access the submaster list by pressing **[Sub] [Sub]** or through the browser (**Record Target Lists>Submaster List>[Select]**).

The list view includes a list of all stored submasters including their label and all recordable properties. You can navigate within the list by using the **[Next]** and **[Last]** buttons or by selecting the desired submaster from the command line.

When this tab is active, the softkeys will repaint to supply you with options to affect the submaster type, or if the submaster is set to independent. You can also move a submaster using **[Move To]**. For example:

- **[Sub] [1] {Mode} [Enter]** - toggles the submaster 1 between “additive”, “effectsub”, and “inhibitive”. This can be done in live as well.
- **[Sub] [2] {Independent} [Enter]** - toggles submaster 2’s independent setting on and off. Independent can only be activated on an additive submaster.
- **[Sub] [2] {Move To} [Sub] [9] [Enter] [Enter]** - moves the contents, label, and timing data from submaster 2 and places it in submaster 9. Submaster 2 is removed.

You may copy the contents of a submaster by using the **[Copy To]** button.

Editing Submasters

If you want to actually edit the contents of the submaster, you can select the submaster and press **{Edit}**. This changes focus to the live/blind display and places you into the blind edit mode for the specified submaster. You may also press **[Blind]** and select the required submaster from the command line.

Any changes made in this screen are automatically stored. A **[Record]** or **[Update]** command is not required.

Chapter 21

Using About

[About] provides detailed information regarding selected elements. When opened, it appears in the CIA and remains open until closed or until another action forces it to close.

This chapter contains the following sections:

- **[About]** 269
- **About System** 269
- **About Channel** 270
- **About Address** 272
- **About Cue** 275
- **About IFCB Palettes** 275
- **About Presets** 275
- **About Groups** 275
- **About Curves** 276
- **About Effects** 276

About [About]

Pressing **[About]** puts the console in “about” mode, which allows you to examine “about” information indefinitely, simply by selecting the element you are interested in.

When in about mode, selecting a channel will reveal information about that channel. Below are examples of the “Current Values” view (see below) of information that is presented when selecting conventional or moving lights.

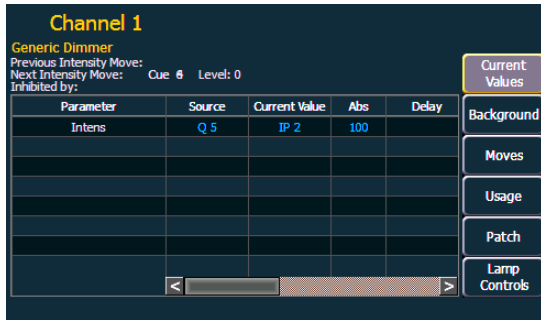

The screenshot shows the 'Channel 1' interface for a 'Generic Dimmer'. The 'Current Values' button is highlighted in gray. The table below shows the current values for the 'Intens' parameter.

Parameter	Source	Current Value	Abs	Delay
Intens	Q 5	IP 2	100	

Conventional Channel Current Values



The screenshot shows the 'Channel 61' interface for an 'ETC Revolution RWM/RWM'. The 'Current Values' button is highlighted in gray. The table below shows the current values for various parameters.

Parameter	Source	Current Value	Abs	Delay
Intens	Q 5	IP 5	50	10
Pan	Q 5	FP 1	-97	15
Tilt	Q 5	FP 1	-41	15
Position MSpeed	Q 5	FP 1	0	15
Scroller	Q 5	CP 3	12	
Hue	Q 5	CP 3	87	
Saturatn	Q 5	CP 3	39	
Scroller Fan	Q 5	CP 3	100	
Scroller MSpeed				

Moving Light Channel Current Values

The buttons on the right side of the about screen alter the information that is displayed for the selected channel. The selected button is highlighted in gray. The buttons are:

- **{Current Values}** - this shows any current information that the channel is receiving and following.
- **{Background}** - this displays any information that is being sent to the channel, but not adhered to since another source has ownership of the channel.
- **{Moves}** - this shows the previous move, value of the previous move, the next move, and its value.
- **{Usage}** - this shows where and how a channel is used.
- **{Patch}** - this displays patch information about the channel.
- **{Lamp Controls}** - this displays any parameters and available RDM commands associated with the channel. If the channel is a conventional (intensity-only) fixture, no parameters will be displayed. If it is a moving light, this key will access lamp controls.

[About]

When **[About]** is pressed, the CIA presents the following information:

- Channel count for the console
- Software version
- Copyright notifications
- Device name
- Assigned as (Primary/Backup/Client/Offline)
- User ID
- Number of patched and unpatched addresses
- Priority (ACN and Net2)
- IP Address

About System

When **{About System}** is pressed, the CIA displays a list of all network devices that are connected to lon. These network devices include:

- Consoles
- RPU and RPU3
- Net3 RVI and RVI3
- PC & Mac Clients
- Net3 Show Control Gateways
- Net3 I/O Gateways
- Legacy Unison CMEi processors
- Unison Paradigm processors
- CEM+ and CEM3
- Net3 Gateways
- ETCNet2 Nodes

Each network device will display the following information:

- Device Type
- Name/Component
- Status
- Connected
- IP Address



Note: *Devices may appear more than once in this list if they have multiple roles on the network.*



Note: *If any errors or warnings are present at the rack, the CEM+ / CEM3 will display in red.*

Clicking on a CEM+ / CEM3 in the **{About System}** list will open the About Rack display, which shows the following information about the rack:

- Rack Name (displays as the title)
- Type
- Ambient Temperature
- Phase A,B,C Voltages
- Frequency
- System Number
- IP Address
- Software Version
- Rack Errors

Buttons available in the About Rack screen are **{Activ. Preset}**, **{Deactiv. Preset}**, and **{Clear Errors}**.



Note:

Clearing CEM+ / CEM3 errors from Ion will be temporary unless the errors have been fixed at the CEM+ / CEM3. Errors displayed on Ion will clear on their own once they have been cleared from the CEM+ / CEM3. Some CEM+ / CEM3 errors can only be cleared at the CEM+ / CEM3.

About Channel

Press **[About]** to put the CIA into “About” mode. When a channel is selected, the information below is displayed. You can select the information you wish to view from the buttons located on the right side of the CIA. The buttons are:

{Current Value} displays information that indicates:

- Channel number
- Device Type
- Most recent intensity move (cue number)
- Next intensity move
- What the channel is inhibited by (if anything)
- Keywords
- Notes
- A list of all parameters on the channel showing the current value and its source, the DMX value, the absolute value, delay and timing information, marking information, and any parked values.

{Background} displays similar information:

- Channel number
- Device Type
- Keywords
- Notes
- A list of all parameters on the channel showing the background value and its source, which shows what the parameters will go to if the current control source is removed. The background data will be represented by the standard color coding scheme.

{Moves} displays information that shows:

- Parameters
- Previous move in the cue list that currently has ownership
- Value of the previous move (preset, palette, or absolute data)
- Next move
- Value of the next move (preset, palette, or absolute data)

{Usage} displays information on how the channel is used, such as:

- Maximum Intensity
- Cue lists it is used in
- Total number of cues it appears in (based on intensity)
- Total number of intensity moves
- List of submasters that include the channel
- List of cues that have move instructions for the channel
- List of cues with dark moves for the channel
- List of cues that the channel is active in
- List of groups that include the channel



Note:

*While in the **{Usage}** screen for About Channel, if another channel is selected, you will need to hit the **{Refresh Usage}** button to see the information for the new channel.*

{Patch} displays the following information:

- Address range
- Proportional patch level
- Curve (if any)
- Preheat information (if any)
- Swap/invert pan/tilt status
- Keywords
- Notes
- List of all parameter values with their address, home value, snap parameter, DMX value, and parked value (if any)

{Lamp Controls} displays controls for the lamp, available RDM commands, or other parameters of the device (if it is a moving light).

Channel 1
Generic Dimmer

Address Range: 350 Proportion: 100 Curve: None
Preheat: None Swap: OFF Invert Pan: OFF Invert Tilt: OFF
Keywords: front_lights
Notes:

Parameter	Address	Home	Park	Snap	DMX
Intens	350	0			0

Click to go to About Address

Current Values
Background
Moves
Usage
Patch
Lamp Controls

About Address

Press **[About]** to put the CIA into “About” mode. When an address is selected, the information below is displayed. You can select the information you wish to view from the buttons located on the right side of the CIA. Additional buttons may display based on RDM and Sensor Feedback if enabled. The buttons are:

{Address} displays the following information:

- Address number (displayed as straight address and port/offset)
- Dimmer label (if any)
- Associated channel number, which is a hyperlink to the **[About]** channel display.
- Part number (if any)
- Notes
- Output value (ACN, Net2, ArtNet, Avab UDP, or DMX)
- Current output value and source of output
- Parameter controlled by the address
- Home Value
- Basic patch information
- Extended patch information (if available)
- If it is a scroller, color/gobo wheel, the assigned scroll or wheel is indicated

{Next Part} & **{Last Part}** will advance to the next part or go back to the previous part. These buttons only display for addresses with parts.

{Go To Patch} is a shortcut to edit the patch for the address selected. This will open up the patch display.

{Library Data} displays the following information:

- Revision number
- Release date
- Open issues list (if available)
- Usage notes including switch settings and configuration (if available)
- Alternate fixture names (if any)

{Lamp Controls} displays controls for the lamp or other parameters of the device (if it is a moving light).

{Address Check} will bring current address to full.

{Next/Last Unpatched} will allow you to see what addresses closest to the current address are currently unpatched.

{Dimmer Feedback} - appears when the current address is patched to a dimmer in an ETC Sensor rack with a CEM+ or CEM3. Sensor feedback must be enabled. See [Sensor Feedback, page 343](#) and [Errors and Warnings, page 86](#) for more information.



Note: *For Sensor feedback, the CEM+ must be running software version 3.0 or later.*

{Dimmer Feedback} displays the following information:

- Name (dimmer name)
- Module type
- Rack/Position
- Rack dimmer level (displayed as a percentage)
- Rack dimmer source
- Recorded load
- Actual load

{Dimmer Feedback} displays the following information, which can be modified from Ion by clicking on the value and entering in a new value:

- Firing Mode
- Control Mode
- Curve
- Threshold
- Scale Minimum
- Scale Maximum
- Preheat Enable
- Preheat Timing
- Advanced Features (AF) Enable

Ion supports the following softkey commands from this display:

- **{Ignore Errors}**
- **{Clear Errors}**



Note: *Clearing CEM+ / CEM3 errors from Ion will be temporary unless the errors have been fixed at the CEM+ / CEM3. Errors displayed on Ion will clear on their own once they have been cleared from the CEM+ / CEM3. Some CEM+ / CEM3 errors can only be cleared at the CEM+ / CEM3.*

{Device Details} - appears when the current address is patched to a RDM device. RDM devices must be enabled through the ECU and discovered through the patch. See [RDM, page 343](#), [{Patch} Display and Settings, page 76](#), and [Errors and Warnings, page 86](#).

{Device Details} displays the information that it receives from the device and allows some changes to be made to:



Note: *Changes may take a few seconds to take effect. They will propagate to the RDM device and then back to the console's patch and about displays.*

- Device Label (displayed at the top by the address number)
- DMX Address (can be changed in this display by clicking on the property or value)



Note: *Changing the address can not cause any part of the fixture to move to a different universe or communication with the device may be lost. The universe is set into the gateways port configuration.*



Note: *Details displayed will vary based on the device.*

- DMX Label (same as the device label, but the label can be changed here by clicking on the property or value)
- Type
- Manufacturer
- Device ID
- Footprint
- Version
- Lamp State
- Lamp Hours
- Head DC Voltage
- Lamp On/Off
- Gel Distance Traveled
- Gel2 Distance Traveled
- Fan RPM
- Ambient Temperature
- Gel Temperature
- Device Errors (will only display if there are current errors)
- Clear Errors

Device Errors are displayed in four different colors depending on severity.



Note: *Color severity is determined by the device manufacturer.*

- Gray - unknown or not an error
- White - Advisory
- Yellow - Warning
- Red - Error

About Cue

Channels	Effects	External Links
1 2 3 4 6>20 46>51 61 62 63 64		Q6 / 1

The following information will be displayed when a cue is selected:

- the cue number
- timing data for the cue (including discrete timing)
- flags
- attributes
- number of moves per IFCB provided by the cue
- current status of the cue
- what channels move in the cue
- any effects running
- external links

About IFCB Palettes

The following information will be displayed when an intensity, focus, color, or beam palette is selected:

- the number of cues the palette is used in
- the number of presets the palette is used in
- the number of channels
- the first cue the palette is used in
- the last cue the palette is used in
- the number of cue lists that use the palette

About Presets

When a preset is selected, the following information will be displayed:

- the number of channels
- the first cue the preset is used in
- the last cue the preset is used in
- the number of cue lists that use the preset

About Groups

When a group is selected, the following information will be displayed:

- the group label (if any)
- the channels in the group

The **{Ordered}** and **{Numerical}** softkeys can be used to change the display view in About Groups.

About Curves

When a curve is selected, the following information will be displayed:

- curve number
- the curve label (if any)
- the channels that use the curve in patch
- the channels that use the curve as a fan curve
- the cues/cue parts that use the curve

About Effects

When an effect is selected, the following information will be displayed:



Note: *To view About Effect in live, the effect must be running.*

- effect number
- effect label (if any)
- list of submasters that use the effect
- list of cues that use the effect



Note: *Any cues or submasters that have overrides, such as rate, for the effect will display an *.*

Chapter 22

Storing and Using Curves

A curve is a relationship between the timing of a fade and the output level of a cue, cue part or dimmer at each point of time during that fade. By using a non-linear curve, you can create a variety of effects, accommodate variations and deficiencies in your lighting equipment, alter the transition ramp, and protect equipment from stress.

This chapter contains the following sections:

- **About Curves** 278
- **Creating a Curve** 279
- **Editing Curves** 280
- **Applying a Curve** 281
- **Delete a Curve** 281

About Curves

You may apply curves to dimmers in patch. Curves may also be applied to cues, to cue parts, and to scroller fans. When applied to a cue, the curve impacts only the intensity moves in that cue. When applied to a cue part, the curve impacts all parameter moves stored in that cue part.

When applied in patch, the intensity transition will follow the ramp defined by the curve during its fade. This value is determined by referencing the output value of the curve at that percentage and outputting the curved level rather than the percent level. Up to 100 points of delineation can be established in a curve, each with its own intensity value if desired.

When applied to a cue, the “percent completion” of the cue is determined by applying the curve’s output level as the percent completion for all fade calculations. For single-part cues, the calculation applies only to intensity. For multipart cues, however, the curve applies to all parameters in the part.

When applied to a scroller fan, the output of the fan will be controlled by the intensity of the channel.

Ion provides ten pre-programmed, commonly used curves. They can be edited or copied to a new curve location. When a pre-established curve is deleted, it will return to its original state.

The curve editor can be accessed by pressing **[Displays] {Curve}** or from the browser, **Browser>Record Target Lists>Curves**. When selected, the curves list will open as a separate tab and the CIA will show the graphical output of the first curve in the list.

You can scroll through the list using the **[Next]** and **[Last]** keys, or you can specify a curve in the command line.

- **{Curve} [9] [0] [4] [Enter]** - selects curve 904 from the list and displays its shape in the CIA.

Creating and Editing Curves

Creating a Curve

When you have opened the curves display (see [About Curves, page 278](#)), you can select a curve or create a new curve by pressing:

- {Curve} [x] [Enter]

If the curve is already stored, the contents are displayed in the CIA. If this is a new curve, a linear curve is displayed.

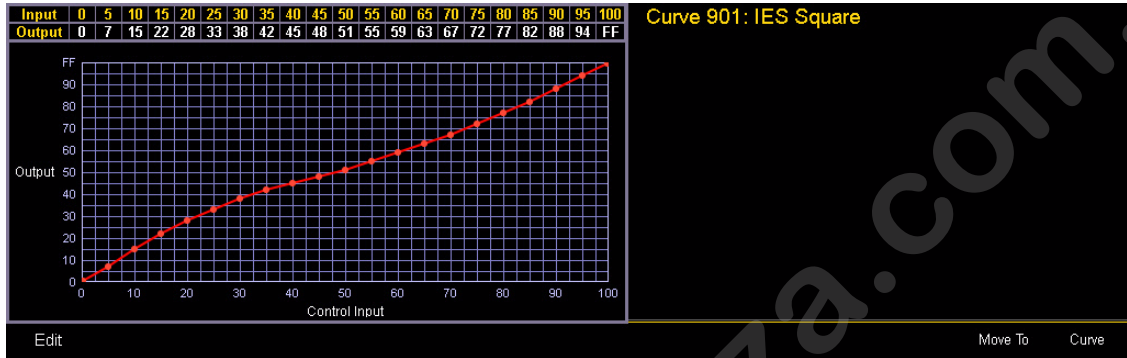

Pre-established Curve

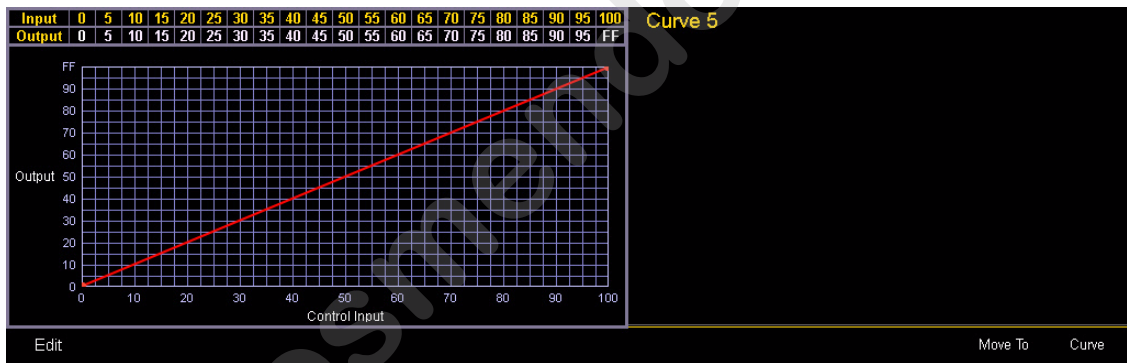

New Default (linear) Curve

Editing Curves

Using the Keypad

Once selected and displayed in the CIA, you can edit a curve from the keypad. Points are established in increments of five. You can add more points from the keypad.

- **[3] [At] [1] [Enter]** - adds control input point “3” and sets its curve level at 10%.
- **[7] [7] [At] [Full] [Enter]** - adds control input point “77” and sets its curve level at full.

You can specify points and adjust their levels in the command line or you may use the keys below to alter the curve:

- **[Page ▶]** - selects the next fade completion point.
- **[Page ◀]** - selects the previous fade completion point.
- **[Level Wheel]** - adjusts the output level of the selected point.
- **[Page ▲]** - raises the selected point’s output by 1%.
- **[Page ▼]** - lowers the selected point’s output by 1%.
- **[Full]** - sets the selected point’s output to full.
- **[Out]** - sets the selected point’s output to zero.
- **[Shift] & [+]** - raises the selected point by the amount for +% established in setup.
- **[Shift] & [-]** - lowers the selected point by the amount for -% established in setup.

Using the curve display

Once a curve is displayed in the CIA, you can press **{Edit}** to edit the curve in the editor display.

In the curve editor you can trace the desired shape of the curve using the mouse on the screen. As you progress through drawing the curve, intensity values will be added for existing points on the curve. If you add points to the curve (from the keypad) those points will be adjusted as well.

You can also toggle between an “interpolated” or “stepped” curve shape. Ion defaults to “interpolated”. To switch to “stepped”, press the **{Stepped}** softkey. Once pressed, this softkey changes to **{Interpolated}**, which allows you to switch back.

Below are two examples of the same curve. The first is interpolated and the second is stepped.

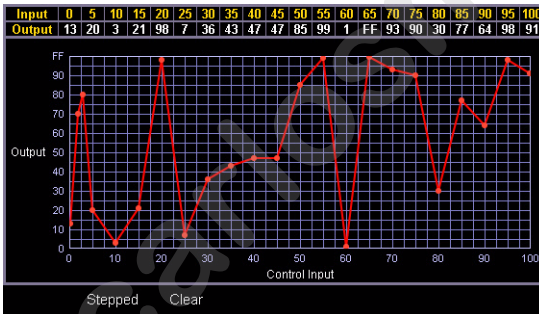

Interpolated Curve

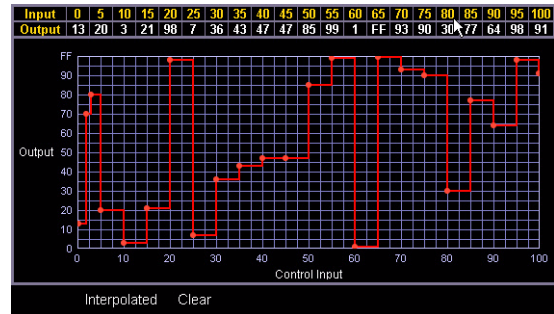

Stepped Curve

Clearing the curve

At any time, you can clear a curve from the curve editor display by pressing the **{Clear}** softkey. This will return the curve to its original linear shape or to its default shape if it is a pre-established curve.

Applying a Curve

To Channels In Patch

Curves can be applied to any intensity parameter in patch. Once added, the curve number appears in the channel's "Curve" column of the patch display. Pressing **{Curve}** in **Patch>Attributes** will display a list of available curves.

- **[Displays] {Patch} {Attributes} [1] {Curve} [9] [0] [1] [Enter]** - applies curve 901 to channel 1 intensity.
- **[Displays] {Patch} {Attributes} [2] [Thru] [8] {Curve} [2] [Enter]** - applies curve 2 to intensity for channels 2 thru 8.
- **[Displays] {Patch} {Attributes} [1] {Curve} [At] [Enter]** - removes the curve from channel 1.

To Cues

Curves can also be applied to cues or cue parts in Live/Blind. This affects the percent completion of the cue or part by applying the curve's output level as the percent completion for all fade calculations. Once added to a cue, the curve number appears in the cue's "Curve" column of the cue list in the playback status display.

- **[Cue] [5] <More SK> {Curve} [4] [Enter]** - applies curve 4 to cue 5.
- **[Cue] [4] [1] [6] [Thru] [9] <More SK> {Curve} [9] [0] [6] [Enter]** - applies curve 906 to cues 4/6 through 4/9.
- **[Cue] [5] <More SK> {Curve} [At] [Enter]** - removes any curve from cue 5.
- **[Cue] [8] [Part] [3] {Curve} [6] [Enter]** - applies curve 6 to part 3 of cue 8.

To Scroller Fans

Curves can also be applied to a scroller fan. When applied to a scroller fan, the output of the fan will be controlled by the intensity of the channel. To apply a curve to a scroller fan, go to **Patch>Attributes> {Fan Curve}**. See ["Scroller Fan Curves" on page 71](#).

Delete a Curve

While in the curve display, you can delete a curve in the following ways:

- **[Delete] {Curve} [3] [Enter] [Enter]** - deletes curve 3 from the list.
- **[Delete] {Curve} [9] [0] [1] [Enter] [Enter]** - since curve 901 is a pre-established curve, this command will return curve 901 to its default state, thereby removing any edits to it.
- **[Delete] [Enter]** - deletes the currently selected curve.

www.carlosmendoza.com.mx

Chapter 23

Storing and Using Snapshots

Snapshots are record targets that store the current state of the Ion console and monitor configuration. These can then be recalled to instantly reset the console and displays to the state stored in the snapshot. You can choose which parts of the console and displays you wish to store as a part of the snapshot.

This chapter contains the following sections:

- **About Snapshots** 284
- **Recording Snapshots** 284
- **Recalling Snapshots** 285
- **Editing Snapshots** 285

About Snapshots

When you record a snapshot, aspects of the Ion user-interface, based on user-preference, are stored so that you can recall them in the future. This allows you to bring the console back to a desired state quickly.

Snapshots can be used on Ion RPU's or Net3 RVI's to change what is currently displayed on the external monitors and how that information is displayed.

Snapshots contents are global. They can be stored and recalled on any control interface, other than Net3 RFR's. When recorded, they store the relevant settings of the device initiating the record. When recalled, they recall only the controls that are appropriate on the device the snapshot is recalled.

Control areas that may be stored in a snapshot are:

- Direct Selects - records the configuration, mapping, and current page of any direct selects in use.
- Encoders - records the current page of the encoders.
- Faders - captures the current state of all the faders including: current page, current fader configuration, position of all submasters and playbacks, any fader attributes, and pending cues.
- Monitors - records the current display and configuration of the external monitors.
- Filters - records the current setting of the record filters.



Note:

*Snapshots that store the faders do **not** include the active cue in a fader. They only include pending cues and fader attributes.*

When snapshots are recorded, you can view them in the snapshot list. To view the list, navigate to **Browser>Record Target Lists>Snapshots**.

Recording Snapshots

To store the current state of the console, record a snapshot.

For Example:

- **[Record] {Snapshots} [1]**

The CIA will display buttons representing the following areas of console:

- Monitors
- Faders
- Encoders
- Direct Selects
- Filters

By default, all of these elements are selected for storing. If you wish to store only some of these elements, select those desired by touching the button in the CIA. Selected elements will be highlighted in gray.

- **{Monitors} {Encoders} {Direct Selects} [Enter]**

You can label snapshots or attach notes as desired.

- **{Snapshots} [1] [Label/Note] [text] [Enter]**

Recalling Snapshots

Snapshots can be recalled in the following ways:

- from the keypad/command line - **{Snapshots} [5] [Enter]**
- from cues using the execute list
- from a recorded macro instruction
- from the direct selects - **{Snapshot 4}**

Since snapshots can be recalled from any device (except RFRs) on the Ion network, snapshots may be affected by the type of device they are recalled on. If the recalling device does not have the same physical layout or has other limitations that differ from the recording device, Ion will map the snapshot to the best of its ability.



Note:

In a system with multiple users, it is recommended that you allot discrete snapshot numbers for each user. Since snapshots are global and can be recorded/recalled from most devices, assigning numbers for each user will ensure their snapshots are stored and edited properly for their device.

Editing Snapshots

To edit or preview the contents of a snapshot, navigate to **Browser>Record Target Lists>Snapshots**.

You can use **[Next]** and **[Last]** to navigate the list or you may specify a snapshot in the command line.

Once a snapshot is specified, the list displays five columns, one for each element. You may change the enabled elements by pressing the CIA buttons or the softkeys found beneath the CIA. If an element is added to the command line using the softkeys, it will be enabled when **[Enter]** is pressed. All other elements will be disabled.

For Example:

- **<Snapshots> [3] {Monitors} [Enter]**

This command will enable the monitors for snapshot 3 *and disable any other elements*.

Deleting Snapshots

You may delete snapshots using the following syntax:

- **[Delete] {Snapshots} [2] [Enter]**
- **[Delete] {Snapshot 5}**

www.carlosmendoza.com.mx

Chapter 24

Storing and Using Macros

Ion provides you with the ability to record macros, which allow you to compose a series of programming actions and be able to execute them later by recalling the macro.

This chapter contains the following sections:

- **About Macros** 288
- **Store a Macro from Live** 288
- **Macro Editor Display** 290
- **Play a Macro** 294
- **Delete a Macro** 294

About Macros

Macros are comprised of any series of button presses (both hard and softkeys), screen commands and events. Ion provides you with the macro feature to simplify complex or repetitive console programming and operating tasks that you perform often.

When you record the series of button presses to a new macro, you can later play it back by simply pressing the macro direct select button, running it from a linked cue, accessing it from a connected show control system, remotely triggering the macro, or running it from another recorded macro.

You may create up to 1,000 macros either from live, using the macro **[Learn]** mode to record a sequence of keystrokes as you perform the operation, or you can create a macro from within the macro editor display, entering and editing keystrokes into the macro content editor without actually executing the instructions.

The macro editor display contains a listing of all recorded macros including labels and the contents of the macros stored. All macro editing is accomplished from the macro editor display.

Store a Macro from Live

The most effective way to store a macro is from live mode using the macro **[Learn]** mode to record a sequence of button presses as you enter them. You can include any button press on the console (hard key or soft key), except **[Macro]**, the arrow keys, **[Escape]**, **[Select]**, and **[Learn]**.

Using the **[Learn]** key

Pressing the **[Learn]** key while in live mode places the console in macro learn mode. The **[Learn]** key flashes and the CIA displays “Learning” above the command line. Assign a number identifier (from 1 to 1000) to the Macro using the control keypad and press **[Enter]**. The CIA flashes “Learning Macro #####” above the command line. This indicates that the console is ready to record the macro.



Note:

*It is helpful if you plan your macro content in advance of the macro record process. While in learn mode, each button press is recorded as content, even the **[Clear]** button if you have mistaken a keystroke. There is no way to fix a content error in live mode, but you can rerecord the macro as needed or you can edit the recorded macro in the macro editor, removing any unneeded commands. See “[Edit an Existing Macro](#)” on page 293.*

Begin writing the sequence of button presses and events for the macro record. When you have finished with the series of events and button presses, press the **[Learn]** key again to exit macro learn mode.

Examples of a macro record function include:

- **[Learn] [1] [Enter] [Go To Cue] [Out] [Time] [0] [Enter] [Learn]** - records macro 1 with the go to cue out command.
- **[Learn] [5] [Enter] [1] [Full] {Chan Check} [Enter] [Learn]** - records macro 5 with channel 1 at full in channel check mode. To check the next channel in the list, press **[Next]**.
- **[Learn] [4] [Enter] [-] [Sub] [Record] [Learn]** - records macro 4 with instructions to record a target excluding all submaster data.
- **[Learn] [2] [Enter] [-] [Group] [6] [Color] [Record] [Learn]** - records macro 2 with instructions to record a target excluding the color data from group 6.

You can also create a macro in live that bumps submasters across fader pages but first you must have content assigned to the submasters.

For Example:

Write submasters 1 through 5 and 15 through 17, each with its own channel selections at 100%. Then press:

- **[Learn] [1] [Enter] [Bump1] [Bump2] [Bump3] [Bump4] [Bump5]**
- **[Fader Page]**
- **[Bump15] [Bump16] [Bump17] [Learn]**

Once you have created the macro from Live in **[Learn]** mode, you can easily edit the sequence from the macro editor display. [See "Macro Editor Display" on page 290.](#)

Macro Editor Display

Macro editing is accomplished from the macro editor display. As an alternative to recording your macro in live, you may create it from this display instead. Open the macro editor display from the browser by navigating to **Record Target Lists > Macro Editor**, then press **[Select]**. The editor will display on an external monitor.

The display is divided horizontally, the top portion displays the macro contents in detail while the bottom portion lists all macros, including the label and contents.

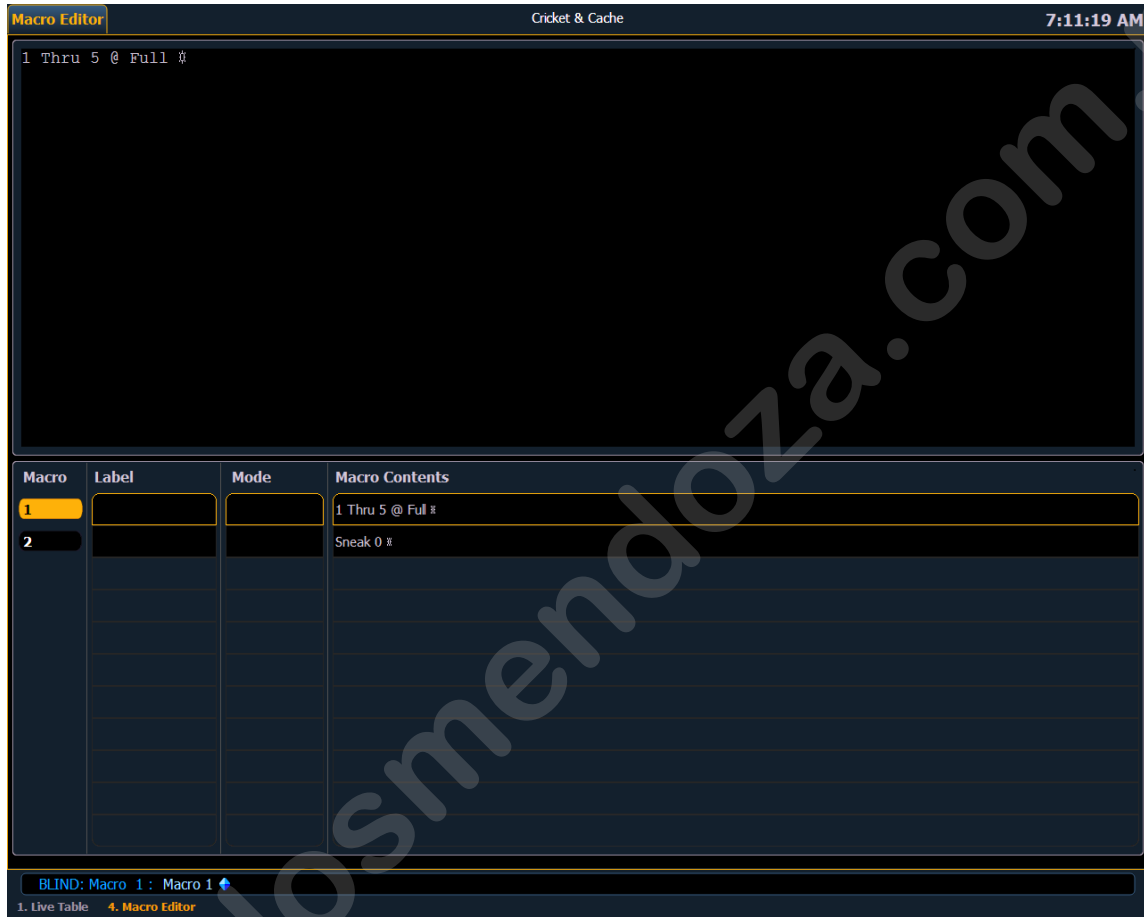

While in the macro editor display, any numeric entry on the command line is assumed to be a macro number. If the macro number entered already exists and **[Enter]** is pressed, the macro list will page to the selected macro and the macro content detail section will display all of the contents of the selected macro. If the macro number entered does not exist in the list and **[Enter]** is pressed, an empty macro will be created with the specified macro number.

While in the macro editor display, the following functions may be performed using the control keypad and softkeys:

- **[Label]** - when a macro is selected and **[Label]** is pressed, the alphanumeric keypad will display on the CIA. Label the macro and press **[Enter]**.
 - **[1] [Label] <name> [Enter]** - labels macro 1
- **[Delete]** - when a macro is selected and **[Delete] [Enter]** is pressed, you will be prompted to confirm the deletion of the selected macro. To confirm press **[Enter]**, to abort press **[Clear]**.
 - **[1] [Delete] [Enter] [Enter]** - deletes macro 1 from the list.
- **[Copy To]** - when a macro is selected and **[Copy To]** is pressed, you will be prompted to enter the macro number that you want to copy the contents of the selected macro to. You will be prompted to confirm the copy process, press **[Enter]** to confirm or **[Clear]** to abort the copy to process.
 - **[1] [Copy To] [6] [Enter] [Enter]** - copies the entire contents of macro 1 to macro 6.
- **{Edit}** - when a macro is selected and **{Edit}** is pressed, you will have entered edit mode for the selected macro. Three notable changes to your macro editor display include:
 - A blinking cursor in the macro content detail portion (top) of the display.
 - "Press **[Select]** to save or **[Escape]** to cancel changes" flashes above the command line.
 - The available softkeys change to **{Loop Begin}**, **{Loop Num}**, **{Wait}**, **{Delete}**, **{Cancel}**, and **{Done}**.
- **{Move To}** - allows you to move and reorganize your macros anywhere in the macro list numerically.
 - For instance, if you have macros 1 through 5 in the list, and you want to move or change macro 1 to macro 6 so that your most commonly used macros are first in the list, you would press **[1] {Move To} [6] [Enter]**. This leaves only macros 2 through 6 in the list.
- **{Macro Mode}** - allows you to assign different modes for the macro to run in. There are three modes: background, foreground, and default.
 - **{Default}**
 - When a macro in default mode is run manually, it runs in the foreground (i.e., the command line) on the device that fired it. When a macro in default mode is executed by a cue or via show control, it runs in the background on the master device.
 - Running a macro on a master device only matters when the macro changes the displays of the device it runs on such as snapshot and flexichannel macros.
 - **{Background}**
 - When a macro in background mode is run manually, it runs on the device that fired it but will not affect its command line.
 - A macro in background mode that is run from a cue or via show control will run on the master device but will not affect the master's command line.
 - When a background macro is running and includes a link to another macro, or is currently waiting, pressing the **[Macro]** button will stop it.
 - **{Foreground}**
 - When a macro in foreground mode is run manually, it runs on the device that fired it and affects its command line.
 - If a foreground mode macro is fired via show control, it runs on the master device and will affect its command line.
 - If a cue fires the macro, it will run on the device whose user last pressed **[Go]** on that playback. If a foreground macro is fired from a cue that is executed from another cue list, the macro will run on the device that last pressed **[Go]** on the cue's playback but not the playback that triggered the executed cue.

Create a New Macro from the Display

From the macro editor display, enter any unrecorded macro number from 1 to 1000 and press **[Enter]**. Your new macro number will display in the macro list in numerical order but will not have a label or any contents.

To store the macro contents, select the macro and press **{Edit}**. A cursor appears flashing in the macro content detail portion of the display, ready for you to add the macro content.

For Example:

Create macro 3. Write the instruction to set all active channels to 50%, then sneak them to their original levels over 10 seconds and last, link to macro 5.

- **<Macro> [3] [Enter]**
- **{Edit}**
- **[Group] [5] [At] [5] [Enter]**
- **[Sneak] [Time] [1] [0] [Enter]**
- **[Macro] [5] [Enter]**
- **[Select]**

While in macro edit mode, all keys are entered as content except the macro editor softkeys, arrow keys, **[Escape]**, **[Select]** and **[Learn]** keys.

Edit an Existing Macro

When you have created a macro using macro learn mode from live or otherwise, you can edit the content of your macro by removing or adding commands and special macro softkey functions (such as wait, loop, and so on).

From the macro editor display, select an existing macro number and press **[Enter]**. The selected macro contents will display the detail section. Press **{Edit}** to make changes to the content.

When in edit mode, the browser changes to display all softkeys available for the system that would otherwise be difficult to find when recording a macro.

↑	Query	Address	Snapshot	Highlight	Assert	
↓	Clear CmdLine	Enable	Disable	Open ML Controls	MIDI Raw	Send String
	Odd	Even	Reverse	Random	Reorder	
Softkeys	SinglePara	MultiParan	MovesOnly	Complete	MinusLinks	Use Marks
Lamp Controls	Manual					
	Is In	Isn't In	Can Be	Can't Be	Or	MovesOnly

Next to the softkeys display are paging buttons to page through the available softkeys. When used, these paging buttons will not be stored as content in your macro.

In addition, a new set of macro editor softkeys are displayed while in edit mode including:

- **{Loop Begin}** - inserts a loop start command.
- **{Loop End}** - inserts an end command for a loop with a limited number of iterations. An infinite loop is assigned when you use "0" for the iterations.
- **{Wait}** - inserts a pause for a period of time. This needs to be followed with a whole number of seconds.
- **{Delete}** - removes commands from the macro.
- **{Wait for Input}** - Inserts a pause in the macro to allow you to enter data. The pause lasts until you press the **[Macro]** key again. Then the remainder of the macro will be completed.
- **{Done}** - exits macro edit mode. You may also use the **[Learn]** key to enter and exit edit mode.

In edit mode, the cursor in the macro content detail section of the display provides use of the arrow keys to navigate through the existing content list. Use of the arrow keys will not be stored to the macro content.

To add content, place the cursor in the section that you want to insert, then add the command. To delete a command, place the cursor ahead of the content to be deleted, then press the **{Delete}** softkey.

Press **[Select]** when you have completed all editing. Press **[Escape]** to abort.

Note:

*Macros for options with a toggle action between enable and disable, such as AutoMark in setup, can use the **{Enable}** and **{Disable}** softkeys for creating absolute actions instead of toggles.*

Play a Macro

You can play a macro from the command line, from the direct selects, run it from a linked cue, or from another macro.

To play macro 5 from the command line press **[Macro] [5] [Enter]**. "Running Macro 5" displays above the command line in live while the macro is running.

To run macro 5 from the macro direct selects simply press **{Macro 5}**. "Running Macro 5" displays above the command line in live while the macro is running.

To run macro 5 from cue 1 press:

- **[Cue] [1] {Execute} [Macro] [5] [Enter]**

If you would like to run multiple macros from cue 1, press:

- **[Cue] [1] {Execute} [Macro] [6] [Enter]**
- **[Cue] [1] {Execute} [Macro] [7] [Enter]**

Each macro has to be entered individually. The previous example would result in macros 5 through 7 being executed from cue 1.

To run a macro from another macro, see the example under [Create a New Macro from the Display](#).

Stop a Macro

If you need to stop a macro while running (for example, during an infinite loop) you may press **[Escape]** and the macro will stop.

Delete a Macro

You can delete a macro from the macro editor display by selecting the macro and pressing **[Delete] [Enter]**. You will be prompted to confirm the deletion. Confirm by pressing **[Enter]** again, or abort by pressing **[Clear]**.

For Example:

Delete macro 5 from the macro list.

- **[5] [Enter]**
- **[Delete] [Enter] [Enter]**

Or from any display:

- **[Delete] [Macro] [5] [Enter]**

Chapter 25

Using Magic Sheets

Magic Sheets are user created custom interactive displays.

This chapter contains the following sections:

- ***About Magic Sheets***296
- ***Magic Sheet Display***297
- ***Navigating a Magic Sheet***299
- ***Creating and Editing Magic Sheets***300
- ***Examples of Magic Sheets***309

About Magic Sheets

Magic Sheets are user created interactive displays that offer customizable views for displaying data and programming. Magic Sheets are comprised of objects that are tied to show data, such as channels and palettes.

The following are two examples of magic sheets. For additional examples, see [Examples of Magic Sheets, page 309](#).

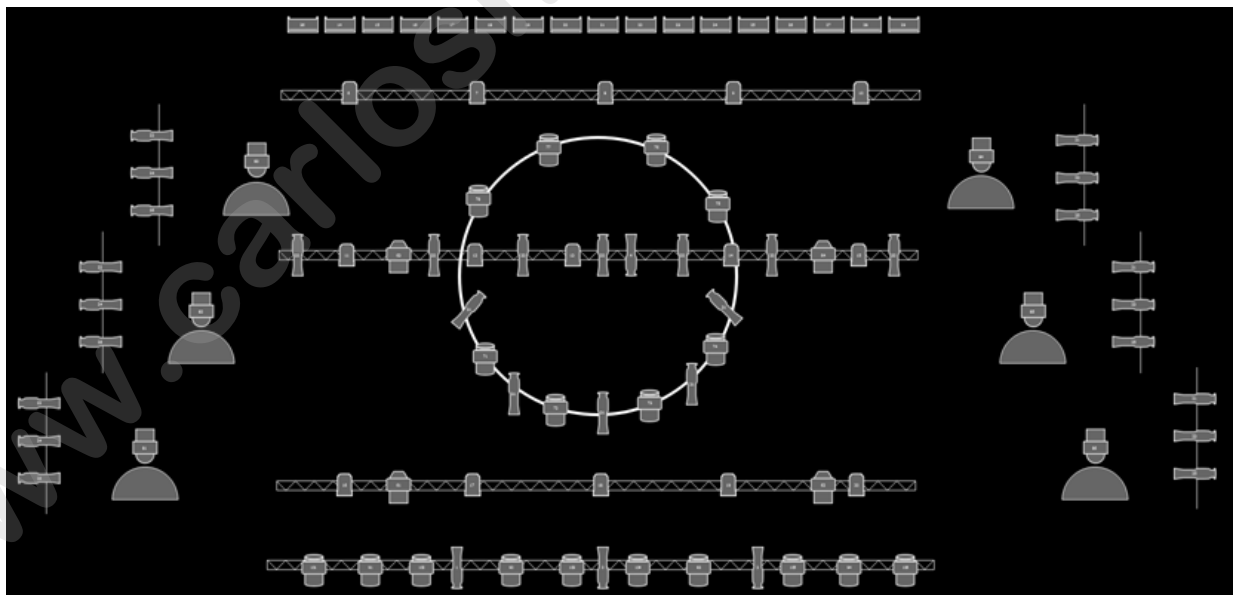

Magic Sheet Display

You can first open the magic sheet display by pressing **[Displays] {Magic Sheet} [Enter]**, or you can navigate within the browser to **Displays> Magic Sheet Display> new** and press **[Select]**.

After you have created a magic sheet, you can recall a specific magic sheet, by pressing **[Displays] {Magic Sheet} [#] [Enter]** or you can navigate within the browser to **Displays> Magic Sheet Display** and press **[Select]**.

All available magic sheets will be displayed in the magic sheet browser.



Magic Sheet List

Double pressing **{Magic Sheet}** or CTRL+S on an external keyboard will open the magic sheet list. The magic sheet list displays a list of all created magic sheets, their labels, and how many views have been saved for each magic sheet. See [Display Tools](#) for more information about views.

To label a magic sheet, use the syntax **{Magic Sheet} [#] [Label] <name> [Enter]**.

Pressing **[Label]**, when a label has already been applied to a magic sheet, will display the label on the command line for editing. Pressing **[Label]** a second time will clear the label, or you can press **[Clear]** to remove the label one character at a time.

Display Tools

Clicking on the triangle in the bottom left corner of the magic sheet display will open a list of the display tools.

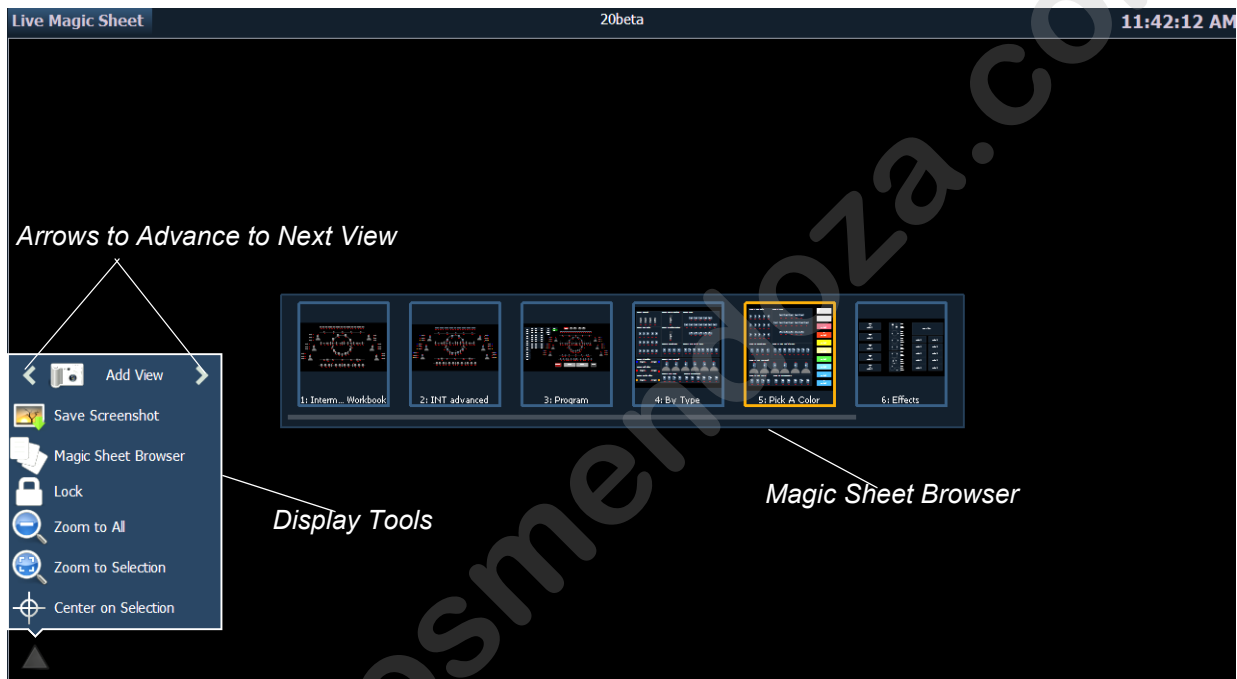

These tools include:

- **Add View** - different views of the same magic sheet can be saved and recalled. Zoom and pan the display to change the view, and then click **{Add View}** to save. To change views, you can use the arrows in the display tools or multi-touch gestures. You can also press **{Magic Sheet} [1] [/] [2] [Enter]** to view Magic Sheet 1, View 2. See [“Multi-Touch Gestures” on page 299](#).
- **Save Screenshot** - saves a .png screenshot of the magic sheet to an attached USB drive.
- **Magic Sheet Browser** - opens the magic sheet browser, which displays thumbnail images and labels for the created magic sheets. The browser can also be opened using multi-touch gestures. See [“Multi-Touch Gestures” on page 299](#).
- **Lock** - locks the magic sheet so it cannot be zoomed or panned. This is useful for a customized direct select layout, where you want the buttons to always be in the same spot.
- **Zoom to All** - zooms to show all objects.
- **Zoom to Selection** - zooms to show all selected objects.
- **Center on Selection** - centers the display on the selected objects without changing the zoom level.

Navigating a Magic Sheet

Magic sheets can be navigated using a mouse, a keyboard, a touchscreen, or a multi-touch touchscreen. The drag and drop function for placing objects is a single touch action or done using a mouse.

Additional mouse commands include:

- **Left Click** - selects an object.
- **Right Click** - pans the display.
- **Wheel** - zooms the magic sheet.
- **[Shift]+ Wheel** - provides a fine zoom of the magic sheet.

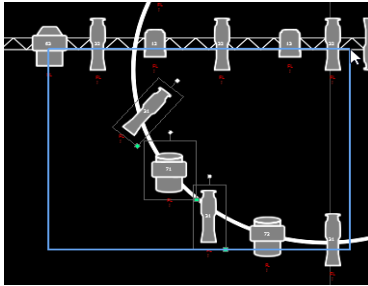

Selecting from left to right will open the blue window selection box. This selects any object that is completely inside of the box. This can be done with a single touch or using a mouse.

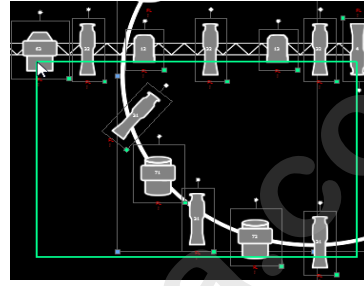

Selecting from right to left will open the green crossing selection box. This selects any object that either crosses the boundary line of the box or is completely inside of it. This can be done with a single touch or using a mouse.

Multi-Touch Gestures

The following multi-touch gestures can be used with an external multi-touch touchscreen.

- **Scroll** - touch with two fingers to move around the page.
- **Zoom Out** - touch with two fingers and then move your fingers toward each other.
- **Zoom In** - touch with two fingers and then move your fingers away from each other.
- **Zoom to All** - double tap with two fingers.

The following multi-touch gestures can be used with monitors that support 3 or more simultaneous touches:

- **Jump to Previous View** - use three fingers to swipe upwards or to the right.
- **Jump to Next View** - use three fingers to swipe downwards or to the left.
- **Magic Sheet Browser** - tap with three fingers to open the browser.

Keyboard Shortcuts

With an external alphanumeric keyboard attached, the following keyboard shortcuts can be used:

- **ARROW KEYS** - move selected item or navigate when nothing is selected.
- **SHIFT** - move/rotate item without snapping to grid.
- **SHIFT + mouse wheel** - provides a fine zoom of the magic sheet.
- **CTRL+S** - double tap to open the magic sheet list.
- **CTRL+A** - select all
- **CTRL+C** - copy
- **CTRL+V** - paste
- **CTRL+X** - cut
- **CTRL+G** - group
- **CTRL+SHIFT+G** - ungroup
- **DELETE** - delete
- **ESC** - finish line/polygon creator or close tab.

Creating and Editing Magic Sheets

Pressing the edit button on the right hand side of the magic sheet display will open the editing tools.

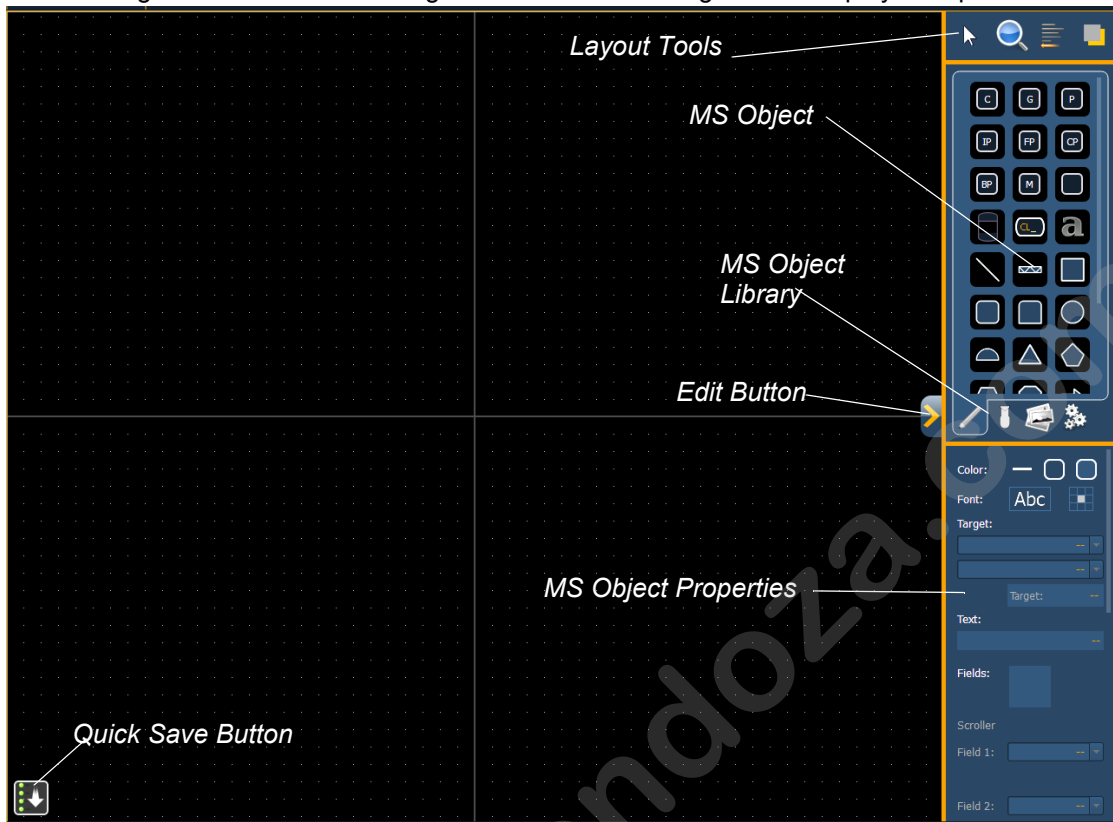

The main area of the magic sheet will display a grid to aid with layout. The editing tools will be displayed on the right side of the magic sheet. The editing tool window is divided up into three areas: layout tools, the MS Object Library, which is made up of four tabs that contain the MS Objects, and the MS Object Properties.

Note: To see a description of a tool or object, hover your cursor over it. Its title will display after a second or two.

You can drag and drop objects onto the magic sheet, or you can use the layout tools to create arrays of objects.

Note: Holding down **[Shift]** while placing an object will bypass the snap to grid behavior.

Quick Save

Clicking on the **{Quick Save}** button allows you to save an undo restore point for the magic sheet you are working on. Once saved, a green check mark will temporarily appear next to the **{Quick Save}** button.



It is recommended that you click **{Quick Save}** before making any major changes to the magic sheet that you think you might want to undo. **[Undo] [Enter]** will take the magic sheet back to the last undo restore point. An undo restore point is also set whenever you exit the editor.

Quick saving a magic sheet will also send any changes made to the magic sheet to all the devices in a multiconsole system.

Layout Tools

The layout tools are divided into four areas: edit mode, zoom, alignment, and ordering.

Edit Mode

Clicking on the arrow will open the edit mode options, which include:

- **Grid Enabled** - toggles between a grid being displayed and no grid. With the grid enabled, the magic sheet will also have a snap to grid behavior when placing objects.
- **Normal** - allows for dragging and dropping of objects from the object list.
- **Quick Layout** - allows you to place more instances of a selected object. When finished, click the **{Done}** button or change the layout mode to normal.
- **Quick Number** - used to quickly assign target numbers to objects. While in quick number mode, clicking on an object will assign the selected target and increment the numbers as specified in the target section of edit mode.
- **Target** - used to specify object, starting target number, and incrementation for use in quick number mode.
 - Object - assigns the object from the list.
 - Start - assigns the starting target number.
 - Increment - assigns what incrementation the target numbers will use after the start number.



Zoom

Clicking on the magnifying glass will open the zoom mode options, which include:

- **Reset Zoom** - sets the zoom level to 1:1 and centers the magic sheet.
- **Zoom to All** - zooms to show all objects.
- **Zoom to Selection** - zooms to show all selected objects.
- **Center on Selection** - centers the display on the selected objects without changing the zoom level.

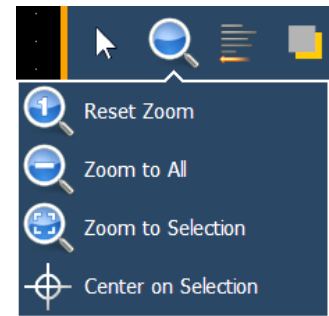

Alignment

Clicking on the alignment icon will open the alignment options, which include:

- **Create Array** - allows you to create arrays of objects. After placing one object of your choice, click on **{Create Array}** to open an additional window for choosing what array type you want to use.

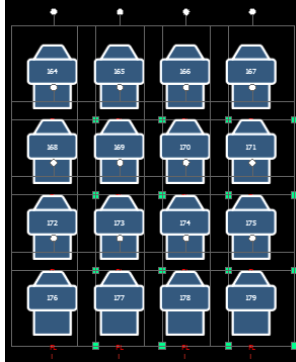

- **Rectangle** - will layout a rectangle array of objects. You can define how many rows, columns, and the spacing.

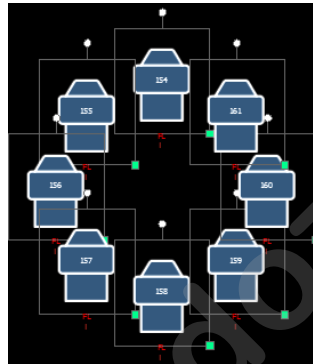

- **Circle** - will layout a circle array of the objects. You can define the number of objects and the size of the circle.

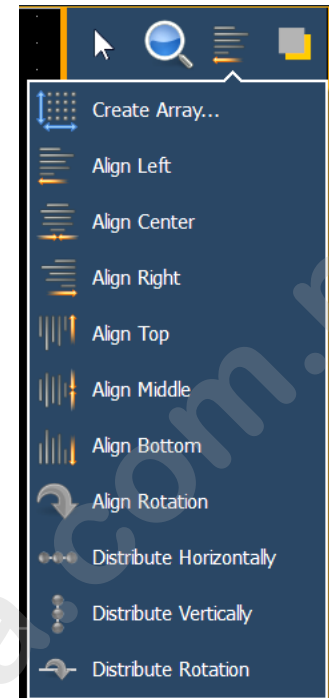

- **Align Settings** - allows you to align objects either to the left, right, center, or top, middle, bottom.

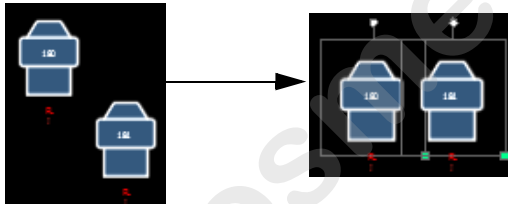

Example of aligning by tops.

- **Align Rotation** - allows you to select multiple objects and align their rotation to the first object selected.

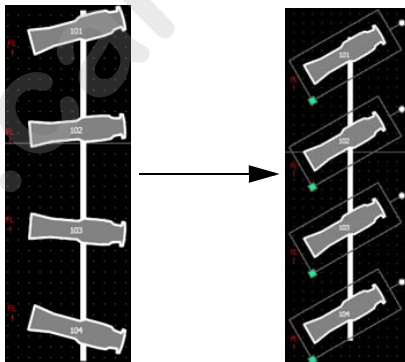

- **Distribute Horizontally** - allows you to distribute objects horizontally at an equal distance apart between two objects. Set the distance you would like by placing the first and last objects. Then with all objects selected that you wish to distribute (including the first and last ones you positioned), click the **{Distribute Horizontally}** button.

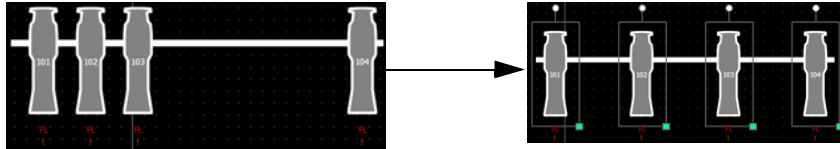

- **Distribute Vertically** - allows you to distribute objects vertically at an equal distance apart between two objects. Set the distance you would like by placing the first and last objects. Then with all objects selected that you wish to distribute (including the first and last ones you positioned), click the **{Distribute Vertically}** button.

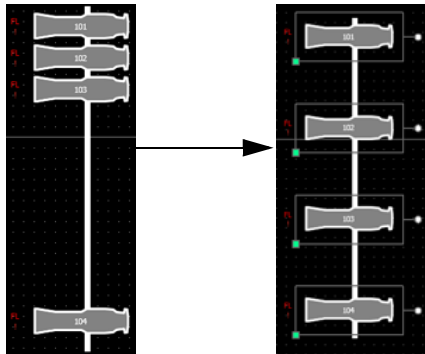

- **Distribute Rotation** - allows you to distribute objects at an equal rotation between two objects. Set the level of rotation you would like by placing the first and last objects at a rotation. Then with all objects selected that you wish to rotate (including the first and last ones you positioned), click the **{Distribute Rotation}** button.



Ordering

The objects can either be placed on their own or stacked on top or beneath of each other.

Clicking on the order icon will open the ordering options, which include:

- **Group** - allows you to group objects together so they can be moved and rotated like a single object.
- **Ungroup** - removes grouping.
- **Send Backward** - will send an object back.
- **Bring Forward** - will send an object up.
- **Send to Bottom** - will send an object beneath all other objects.
- **Bring to Top** - will stack an object on top of all other objects.

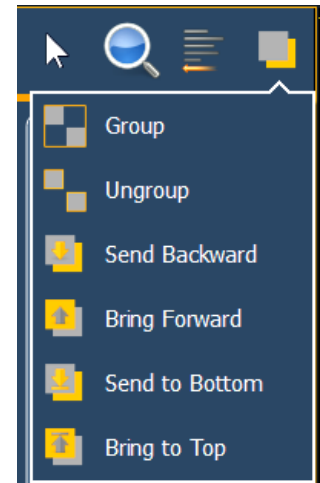













Magic Sheet Object Library

The objects section of the editing tools has four tabs: objects, fixture symbols, backgrounds, and background settings.

MS Objects

The following table contains the various magic sheet objects located in the first tab, and a brief

description of what they do. Settings for objects can be adjusted in the [MS Object Properties](#) area.

Channel		acts as a direct select for a channel.
Group		acts as a direct select for a group.
Preset		acts as a direct select for a preset.
Palettes		acts as a direct select for a palette.
Macro		acts as a direct select for a macro.
Blank		can be assigned a target.
Tombstone		mirrors the channel indicators from the live/blind summary view.
Command Line		mirrors the command line. Can be assigned to mirror the command line for any user. Multiple command lines for different users can be used.
Text		places descriptive text on the sheet. The text can also be assigned a target.
Line		draws a line. Examples of use could be as a pipe for fixtures or a divider between buttons.
Truss		places truss.
Shapes		draws shapes that can have a target assigned to them or could be used to represent set pieces.
Points		allows for free form creation of objects.

Fixture Symbols

From the second tab, fixture symbols can be placed on a magic sheet. The symbols can be tied to a channel number. Information about that channel can be displayed with the symbol, such as intensity, FCB data, and error indicators. See [MS Object Properties, page 307](#) for more information on the customizing options available.

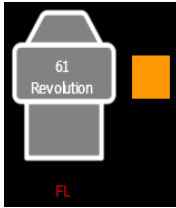

An example of a fixture showing the channel number, fixture type, intensity, and a color swatch.

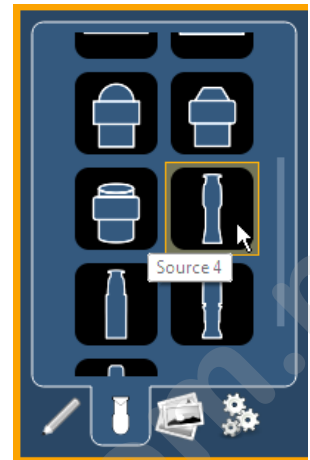

Importing Fixture Symbols

Additional fixture symbols can be imported. The symbol must be saved as a .svg image file, and it needs to be tagged properly.

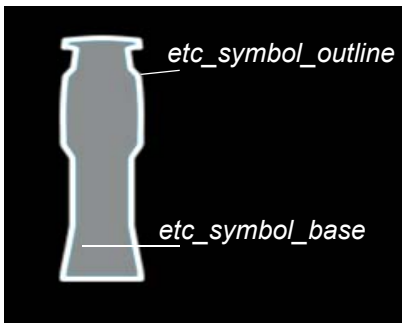

The outline section needs to be tagged as etc_symbol_outline and the base section needs to be tagged as etc_symbol_base.

The edits to the tags in the .svg file can be made in any text editor program, such as Notepad, or in a .SVG editor program, such as Inkscape.

See [Images](#) for steps on importing.

Images

Images from the third tab can be imported into magic sheets for two different purposes. They can be used as background images or as icons.

You can use a graphics image file as a background or icon. The following is a list of accepted image formats: .bmp, .gif, .ico, .jpg, .pbm, .pgm, .png, .ppm, .svg, .svgz, .tga, .tiff, .xbm, and .xpm. The maximum image size allowed is 1920 x 1920. Larger images will be scaled to this size.

You will need to have the images on a USB drive to import them into the desk.

Once an image has been imported, it is saved with the show file.

To import an image:

- Step 1: Click on the import image icon. A separate window will open displaying any found USB drives.
- Step 2: Select the appropriate drive.
- Step 3: Navigate to the file you use to upload.
- Step 4: Click on the file and then press **{Ok}**. It will now appear in the images tab.

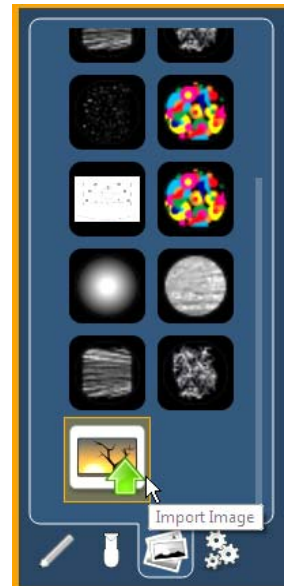

Click on an image to select it. To use as an icon, drag and drop the image onto the magic sheet. You will be able to resize it. See ["Editing Objects on the Magic Sheet" on page 308](#).

Background images need to be set in the background settings tab. You can also adjust the background settings there. See ["Background Settings" on page 306](#).

Background Settings

In the fourth tab, you can adjust the settings for the background. Three options are available for background types; you can either use a solid color, a gradient of two colors, or an image.

Solid

When solid is selected, you will have the chance to select a color for the magic sheet background. You can either click on the color square in the tab, which opens a color selection window, or you can manually enter the RGB values.



You can manually enter the RGB values in here or in the settings tab.

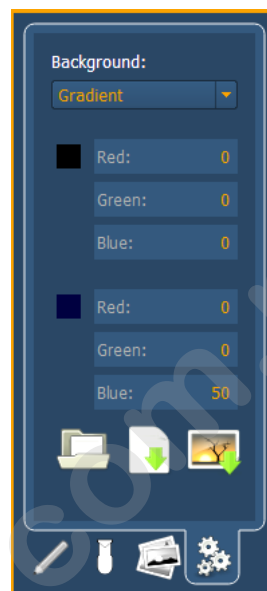

Gradient

When gradient is selected, you will have the chance to select a two color gradient for the magic sheet background. You can either click on the color squares in the tab, which open a color selection window, or you can manually enter the RGB values.

Image

With image selected, you can adjust the size, opacity, and invert the colors of the selected background image.

You can select or import an image directly from this tab by pressing the choose a background image icon, if no previous image had been chosen, or by pressing the thumbnail icon of the selected image to change it.

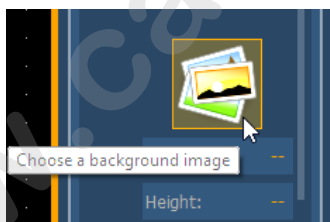

Exporting and Importing Magic Sheets

Magic Sheets can be exported and imported in .xml format. The export and import icons are located at the bottom of the background settings tab.

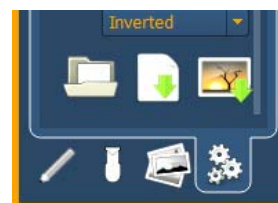

MS Object Properties

You can customize MS objects and fixture symbols in numerous ways found in the MS Object Properties area. With an object selected, you can select options.

The customizable options include:

- **Color** - the object's outline width, outline and fill colors can be adjusted here. The object's colors can either be set or tied to a channel's color.
- **Font** - the font used for a text object can be changed and adjusted as needed here. You can select font type, size, color, bold, italic, underline, and justification.
- **Target** - selects the target of the object. Most objects default to a target type, but that can be changed. The targets available are:
 - Beam Palette
 - Channel
 - Color Palette
 - Cue
 - Effect
 - Focus Palette
 - Group
 - Intensity Palette
 - Macro
 - Magic Sheet
 - Pixel Map
 - Preset
 - Snapshot
 - Submaster
 - User
 - Console Button
 - Zoom - when clicked, the view will zoom in to show all object within that object's group.
 - Selection - when clicked, all other objects within that object's group will be selected.
- **Text** - changes the text for a text object.
- **Fields** - up to six different fields of custom information can be displayed per objects. The justification of each field around the object can be adjusted. The text and color used for each field can also be adjusted. A scroller indicator bar can be added. Fields can display the following data:
 - Target ID
 - Fixture Type
 - Target Name
 - Label
 - Text 1-4
 - Intensity
 - Intensity Bar
 - Color Swatch
 - Summary
 - Focus
 - Color
 - Beam
 - Status
 - Prev Move
 - Next Move

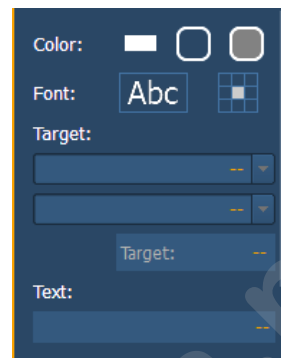

Field Orientation





Note:

If multiple fields have the same justification, they will be stacked in field order.

The orientation of fields around the object can be adjusted by pressing the field orientation icon. You can also choose to keep text upright by pressing the icon to the right of the orientation icon.

There are three options for orientation.

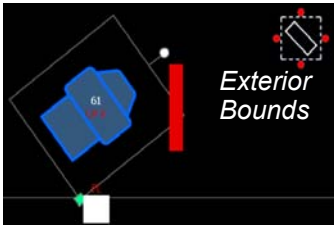

The fields will be exterior to the object and will remain at a position regardless of the rotation of the object.

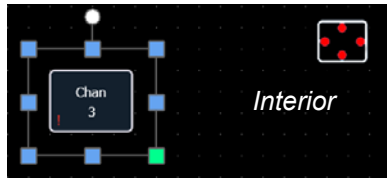

The fields will be in the interior of the object. This orientation is useful for desk buttons.

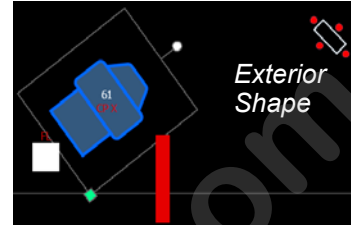

The fields will be exterior to the object and will move in relation to the object's rotation.

- **Position** - shows the position of the object on the magic sheet. Position can be manually entered here.
- **Size** - shows the size of the object. Size can be manually entered here.
- **Rotation** - shows the rotation of the object. Rotation can be manually entered here.
- **Items** - refers to the number of objects selected for editing. Multiple objects can be edited at the same time.

Editing Objects on the Magic Sheet

In addition to using the editing tools, objects can be manipulated on the magic sheet using a touchscreen or a mouse. For selection methods for multiple objects, see [Navigating a Magic Sheet, page 299](#).

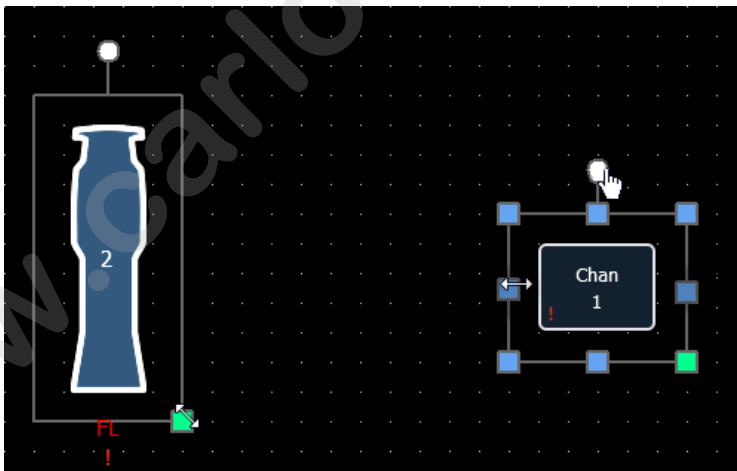

The blue handles are used to resize objects without keeping the object's aspect ratio.

The green handles are used to resize the object preserving the object's aspect ratio.

The white handles are used to rotate the object.

Examples of Magic Sheets

The following are examples of magic sheets created using the magic sheets feature. These examples use a variety of objects provided in the software along with user-generated images.

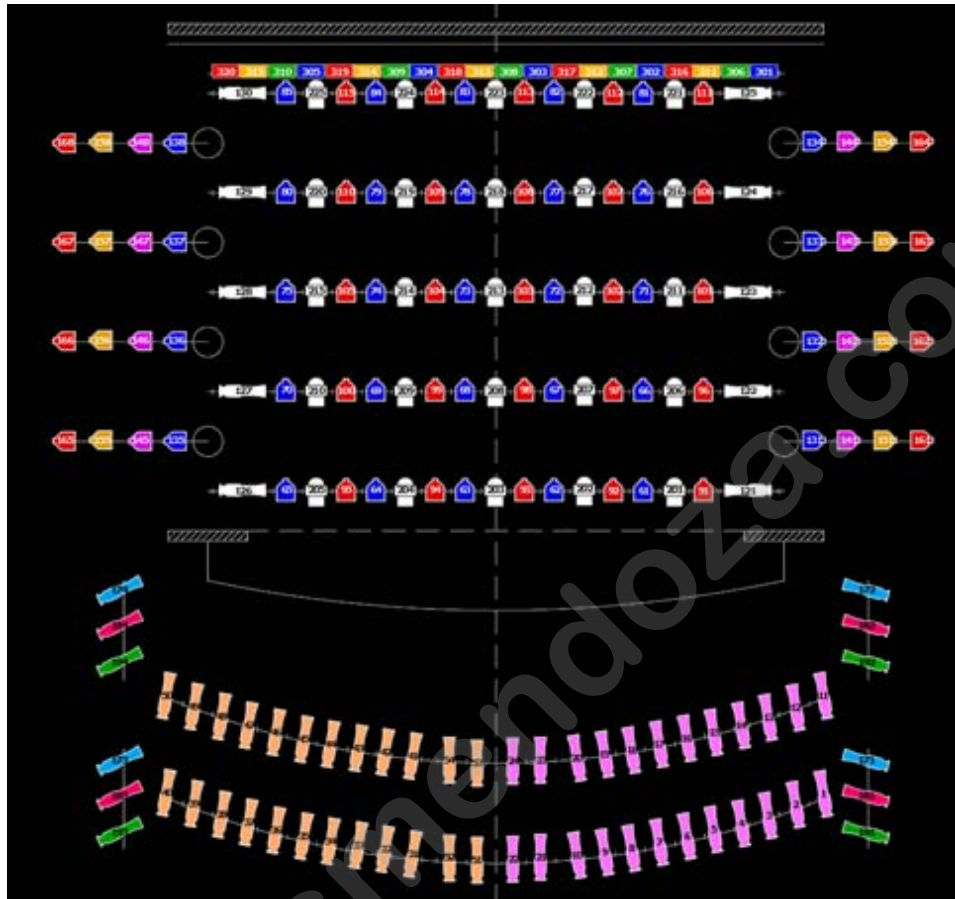

Group 10 Revolutions	↑ ↓	Effect 904 Can Can	Stop Effect	
Group 11 Mac 700's "O" truss	↻	Effect 901 Circle	Rate @ 10	Size @ 10
Group 12 Mac 2K's Ground	↻	Effect 908 Reverse Circle	Rate @ 50	Size @ 50
Group 13 Mac 2K Pros	◻	Effect 902 Square	Rate @ 100	Size @ 100
Group 14 VL 3500 Spots	◻	Effect 907 Reverse Sqr	Rate @ 200	Size @ 200
	◻	Effect 905 Triangle	Rate @ 400	Size @ 400
	◻	Effect 903 Figure 8		

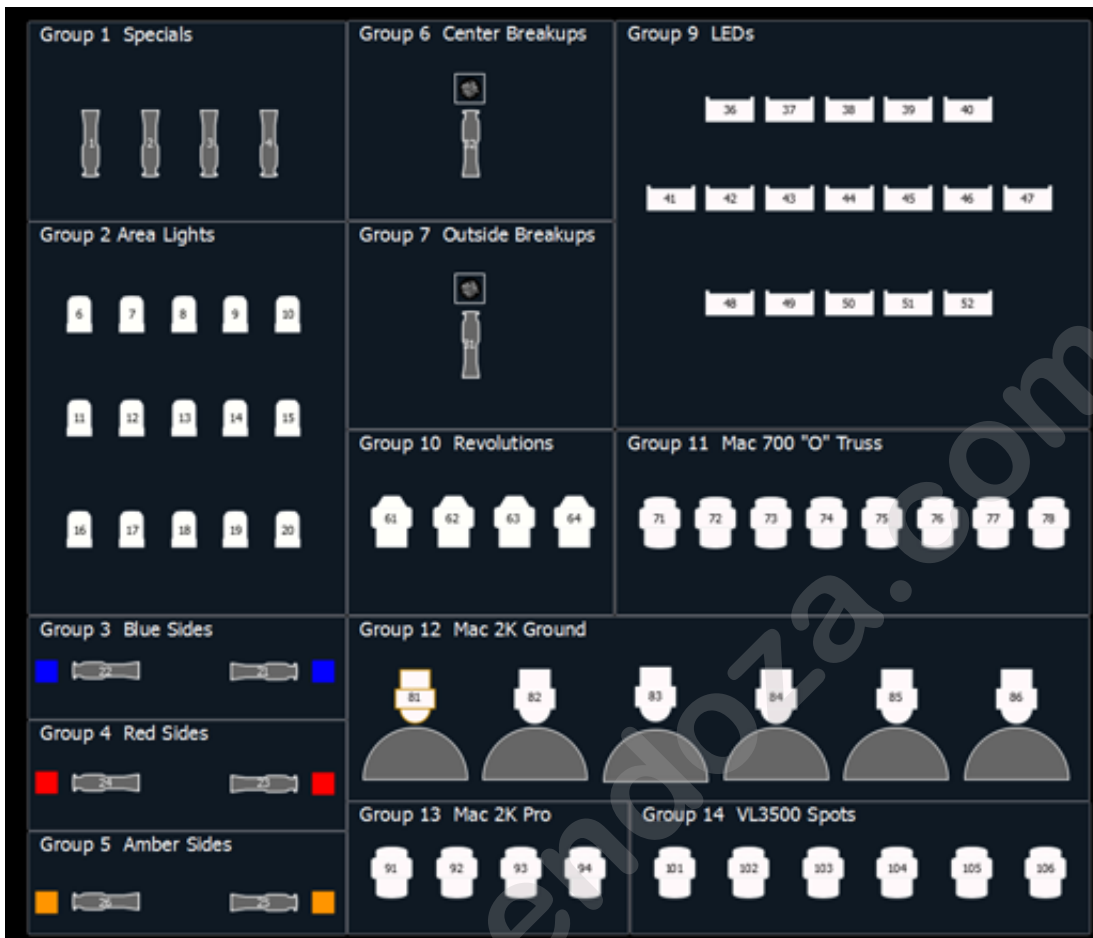

Chapter 26

Virtual Media Server

This chapter contains the following sections:

- [About Virtual Media Server](#) 312
- [Pixel Mapping in a Multi-Console System](#) 324

About Virtual Media Server

The virtual media server feature of Ion is comprised of two areas, the virtual media server and its virtual layers, and pixel maps. These areas are completely dependent on each other.

The virtual media server is a feature used to create layouts of fixtures, known as pixel maps, which then applies media content (images, movies, text, and procedurally generated effects) by way of virtual media layers to the pixel map.

A pixel map is a layout of fixtures onto a grid, which determines order of playback and how the data will be interpreted and outputted to create the desired image or effect. A pixel map creates relationships among the channels in an X-Y grid so that the channels and their parameters can be associated with pixels in an image.

A virtual media layer contains one piece of media content. A pixel map can contain up to 12 virtual media layers, which can be stacked on top of each other or used separately.

Media Content

Images, movies, text, and html files can be applied to a pixel map. A stock library of media is provided when the Eos Family Pixel Mapping Installer is installed. Please see the Eos Family Pixel Mapping Installer v1.0.0 Release Note for installation instructions.

Additional media content can be installed. Supported media file formats are:

- Images - .png, .jpg, .gif, .tiff, and .svg
- Movies - any format that QuickTime® supports (.3gp .3gpp .3gpp2 .3gp2 .3g2 .3p2 .flc .h264 .hdmov .m4a .m4b .m4p .moov .moov .mov .movie .mp4 .mpg4 .mpg4 .mqv .mv4 .pic .pict .qif .qt .qti .qtif .tvod .vid)
- Text - .txt
- HTML - .htm, .html

Importing Media Content

There are three ways to import media. Those methods are:

- Import All Pixel Map Media - An automatic method for importing media.
- File Manager - A manual method for importing media.
- Import Show Pixel Map Media - An automatic method of importing all media needed for the current show file. Used by backup and clients. For more information on synchronizing media content, [See “Synchronizing Media Archives” on page 325.](#)

File names for media content need to follow the naming convention of file number_filename. For example, 002_Volcano.mov is a file name that would be recognized. When importing by using the file manager, you need to number the files prior to importing. However using Import All Pixel Map Media allows you to specify the library and file numbers, and the console will autonumber the file names as needed during the import process.

Using Import All Pixel Map Media

To import go to **Browser>Import>Import Pixel Map Media>Import All Pixel Map Media** and select the device with the media on it.

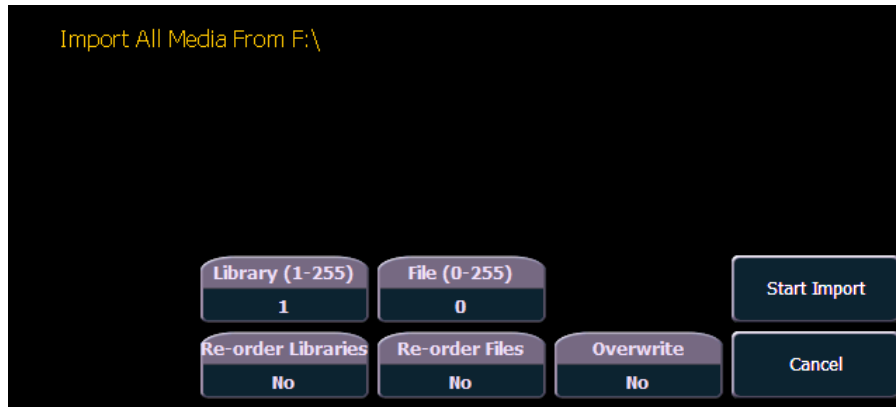

Options in this display include:

- **{Library(1-255)}** - selects the library to import media.
- **{File(0-255)}** - selects the file number.
- **{Reorder Libraries}** - specify whether or not the library on the source device will be renumbered. If the source device's library is not numbered, it will be assigned the specified library number.
- **{Reorder Files}** - specify whether or not the file(s) on the source device will be renumbered. If the source device's file(s) is not numbered, it will be assigned the specified file number.
- **{Overwrite}** - overwrite the existing media files.
- **{Start Import}** - begins the import process. A progress bar will appear to indicate the status of the import process. When finished, click **{Done}**.
- **{Cancel}** - stops the import, and exits the display.

Importing with the File Manager

To import go to **ECU>Settings>Maintenance>File Manager**.



Note: *Make sure your files follow the naming convention of file number_filename. If the files do not, they will not be recognized as media files. You can always import using Import All Pixel Map Media instead.*

Select the device with the media on it in one window and in the other window select the MediaArchive folder. Inside the MediaArchive folder, you will see numbered folders. Those folders correspond to libraries. You can copy or move files.

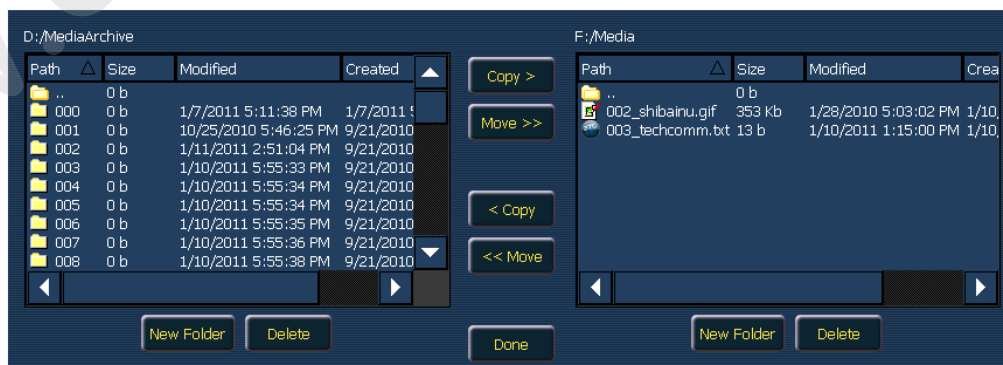

Exporting Media Content

There are two ways to export media. Those methods are:

- Export Pixel Map Media - An automatic method for exporting media.
- File Manager - A manual method for exporting media.

Using Export Pixel Map Media

This is an automatic method of exporting all the media used in the current show file. This includes any pixel map media stored in cues, presets, submasters, etc.

To export, go to **Browser>Export>Export Pixel Map Media**. Select the device you want to export the media content to.

There are only two options available in this display:

- **{Start Export}** - begins the export process. A progress bar will appear to indicate the status of the import process. When finished, click **{Done}**.
- **{Cancel}** - stops the export and exits the display.

Using File Manager

Exporting with the file manager is very similar to importing with it. You select the files in the MediaArchive folder that you wish to export, and you can either copy or move them to your device.

Patching the Virtual Media Server and Layers

To get started using this feature, you must first patch a channel as the Virtual Media Server and additional channels as layers.

You will need to be in the patch by channel display.

In the patch display, enter the channel number that will be your virtual media server. Press **{Type}** then **{Manufctr}** to display the fixture library. Select **{ETC}**, **{Virtual}**, and then **{Server_Ver_1.0}**.

Enter the channel numbers that will be your virtual media layers. Press **{Type}** then **{Manufctr}** to display the fixture library. Select **{ETC}**, **{Virtual}**, and then **{Layer_Ver_1.0}**.

For information about **{Virtual Effect Layer}**, [See “Effect Layers” on page 322.](#)

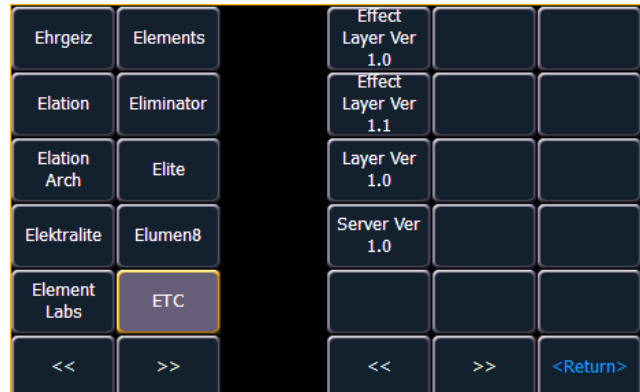

Note:

No addresses need to be assigned in patch for the virtual media server and layers.

Creating a Pixel Map

A pixel map is a layout of fixtures onto a grid, which determines order of playback and how the media content will be interpreted and outputted to create the desired image or effect.

A pixel map creates relationships among the fixtures in an X-Y grid so that the channels and their parameters can be associated with pixels in an image.

Limitations of pixel maps include:

- 10 pixel maps per show file
- 12 layers per pixel map
- 16,384 pixels per pixel map grid

Open up the Pixel Map display, **Displays>More SK> Pixel Maps**



Note:

Hovering your cursor above the pixel map will display the column and row location for the pixel.

The screenshot shows the 'Pixel Map' interface. At the top, it says 'Pixel Map' on the left, '(untitled)' in the center, and '4:24:01 PM' on the right. The main area is a 32x32 grid of yellow squares. A mouse cursor is hovering over a square, and a small grey box next to it displays the coordinates '(25,18)'. Below the grid is a control panel with the following fields:

Pixel Map	Server Channel	Label	Interface	Width	Height	Layer Channels	Pixels	Fixtures
1	1		ACN EDMX	32	32	2, 3	1024	1024

In the Pixel Map display, any numeric entry is assumed to be a Pixel Map. Each pixel map must have a unique number.

To create a pixel map, type in the number you want to assign to it and hit **[Enter]**.

The virtual media server and layer(s) need to be assigned to the pixel map. Using the softkeys, select **{Server Channel}** and the channel you patched as the Virtual Media Server.

Then select **{Layer Channels}** and the channels you patched as Virtual Media Layers.

In this display you can also label the pixel map, assign the interfaces it will use, and adjust the width and height.

Column and row guides can be created numerically in either the Pixel Map or in the Edit displays. The guides can aid in viewing a pixel map.

When that basic information has been assigned to the pixel map, press the **{Edit}** softkey to select the fixtures.

In the edit screen, you will be able to define the array and types of fixtures. To do this, you can select pixels from the map by using a touchscreen or by holding down the left button on a mouse and dragging across the pixels you wish to select.

Once the pixels have been selected, you need to select their fixture type and then assign the starting address. By default, the addresses will be organized in rows starting from the left to the right and top to bottom. The edit screen shows a representation of the current mapping.



Note: *Any pixel can have its size adjusted for better representation of the actual fixtures. This is done by selecting the pixel and then dragging the vertical and/or horizontal borders.*



Note: *A pixel map can be moved within the edit display by holding down the right mouse button. The map can be zoomed either by using a mouse wheel or by holding down **[Format]** and moving the level wheel.*

Options available for changing the mapping:

- **{Horizontal Order}** - toggle state from left to right to right to left
- **{Vertical Order}** - toggle state from top to bottom to bottom to top
- **{Direction}** - toggle state from rows to columns
- Click the **{Apply}** button to see the changes made while still in the edit display.

In the edit display, the softkeys will repaint to the following mapping options:



Note: *To see the changes made by using the softkey mapping options, you don't need to press **{Apply}**.*

- **{Rotate 90}**
- **{Flip V}**
- **{Flip H}**
- **{Invert}**

The **{Flash}** button can be used to check the address output while still in the edit display.

When editing is finished, press the **{Done}** softkey to exit the edit display.

Working with the Virtual Media Server

Before you begin working with the Virtual Media Server, you will want to open the Pixel Map Preview display, **Displays>Virtual Controls>Pixel Map Preview**. For manipulating the pixel maps, you can use either the encoders or the ML Controls (**Displays>Virtual Controls>ML Controls**).



Note: *For any output, the Server Channel must be set to a level along with any layers you are using.*

Server Channel Controls

When working with the Server Channel, the following controls will be available:

- **{Intensity}**
- **{Pan}** and **{Tilt}** - used to adjust layers within the frame.
- **{Color}** - filters color for all layers.
- **{FoView}** - field of view, or perspective.
- **{Crossfade}** - used to adjust the priority when devices in the pixel map are also used as desk channels. -100 gives the pixel map priority, and +100 give the desk channel priority. At 0 (the default) the output is calculated HTP for intensity and LTP for NPs.
- **{Scale}** - adjusts Scale of all layers.
- **{Aspect Ratio}** - adjusts aspect ratio of all layers.
- **{XYZ Rotation Controls}** - rotation control for all layers

Layer Channel Controls

When working with the Layer Channels, the following controls will be available:

- **{Intensity}**
- **{Pan}** and **{Tilt}** - used to adjust the image of the individual layer within the frame.
- **{Color}** - filters the color of the content. For example, if all the colors are set to full, the content will play all colors normally. However if blue is at 0, then only the red and green pixels of the content will play. The color and gel pickers can be used to select color filtering quickly.
- **{Negative On/Off}** - with negative on, the output is the negative of the content. With it off, the content plays back normally.
- **{Image Brightness}** - this varies from intensity. The following images illustrates the differences between image brightness and intensity.



Note: *All Virtual Media Layers operate in 16-bit color mode.*



0% Brightness, Full Intensity

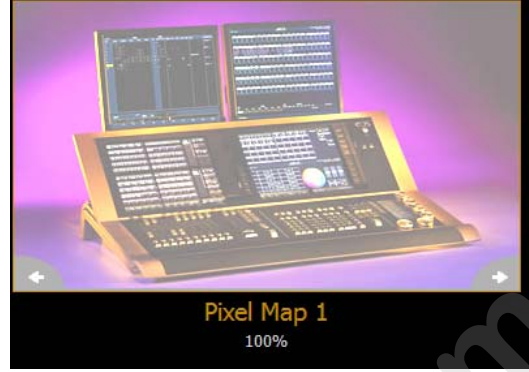

50% Brightness, Full Intensity

- **{Playback Mode 1}:**

- {Display Centered}
- {Display In Frame}
- {Display Out Frame}
- {Play Loop Forward}
- {Play Loop Reverse}
- {Play Once Forward}
- {Play Once Reverse}
- {Stop}

- **{Playback Speed}**

- **{In Point}** - determines where in the clip (frame number) you want to enter in.

- **{Out Point}** - determines where in the clip (frame number) you want to exit.





- **{Mix Modes}** - sets how the layers will interact. The following table shows the various mixer modes available. To illustrate the modes, the following layers were used:













Top Layer



Bottom Layer

Mode	Description	Result
{Over} (Default)	Top layer blended with bottom layer	
{In}	Top layer with opacity reduced by opacity of bottom layer	
{Out}	Top layer with opacity reduced by inverse opacity of bottom layer	
{Atop}	Top layer with opacity reduced by opacity of bottom layer and then blended with bottom layer	
{Add}	Top and bottom layers color and opacity added together	

Mode	Description	Result
{Subtract}	Top and bottom layers color and opacity subtracted from each other	
{Multiply}	Top and bottom layers color and opacity multiplied together	
{Screen}	Top and bottom layers colors inverted and then multiplied together	
{Overlay}	Does a multiply or screen effect based on the lightness or darkness of the bottom layer	
{Lighten}	Top layer's color merges with bottom layer's color, with the lighter color winning	

Mode	Description	Result
{Darken}	Top layer's color merges with the bottom layer's color, with the darker color winning	
{Dodge}	Bottom layer's color brightened to reflect top layer's color	
{Burn}	Bottom layer's color darkened to reflect the top layer's color	
{Hard Light}	Does a multiply or screen effect on the lightness or darkness of the top layer	
{Soft Light}	Darkens or lightens colors depending on the top layer	

Mode	Description	Result
{Xor}	Top layer with opacity reduced by inverse opacity of bottom layer, and then blended with the bottom layer with opacity reduced by the inverse opacity of the top layer	

- **{Library}** - selects the image library.
- **{File}** - selects the media file within the selected library.
- **{Mask On/Off}** - masks takes a lower layer and a higher layer, finds only the non-transparent pixels they have in common, and then displays the common pixels of the higher layer.
- **{FoView}** - perspective
- **{Scale}** - changes the scale of the content to either be larger or smaller than the standard content playback.
- **{Aspect Ratio}** - stretches or shrinks the content only along the X axis, making it wide or squished looking. Z Rotate can be used to modify the aspect ratio along the Y axis.
- **{XYZ Rotation Controls}**

Effect Layers

The Virtual Media Server allows you to use procedurally generated content. This is content that is created algorithmically in real time, instead of rendering file based media.

In order to use procedurally generated content, you must patch the pixel map layer as a virtual effect layer instead of a virtual media layer. Setting up the pixel map is the same as for using virtual media layers. There are two versions of the effect layer, **{Effect Layer Ver 1.0}** and **{Effect Layer Ver 1.1}**.

Types of Effects

There are three main effect types:

- Two color gradients - adjustable gradients with start and end colors
- Rainbow gradients - fixed gradient, full hue spectrum
- Perlin noise - good for animating random color effects, adjustable gradients

The effects are stored in file 1. File 1:0 is a home position of no effect. 1 - 3 are perlin noise effects, 4 is a perlin noise/rainbow gradient, 5-9 are rainbow gradients, and 10-19 are two color gradients.

Effects have various options of additional control.



Using Two Color Gradients

For the effects that use two color gradients (two color and perlin noise), there are several options for control of the gradients. The two colors are known as the start and end colors. Those options include:

- **{Intensity}** and **{Intensity 2}** - specifies the opacity of the start and end colors respectively for Virtual Effect Layer 1.0. If you want to fade a two color effect using this layer, you will need to fade both **{Intensity}** and **{Intensity 2}**.
- **{Intensity 2}** and **{Intensity 3}** - specifies the opacity of the start and end colors respectively. **{Intensity}** is a master opacity control for the entire layer. This is for Virtual Effect Layer 1.1. If you want to fade a two color effect using this layer, you can just fade the **{Intensity}**.
- **{Red}**, **{Green}**, **{Blue}** or **{Hue}** and **{Saturation}** - specifies the start color.
- **{Red 2}**, **{Blue 2}**, and **{Green 2}** - specifies the end color.
- **{In Point 1}** and **{Out Point 1}** - changes the distribution of the two colors in the gradient. In Point 1 moves the start color position closer to the end color. Out Point 1 moves the end color position closer to the start color.
- **{Playback Mode 1}** - basic animation, forward or reverse.
- **{Playback Speed 1}** - speed of animation.
- **{Layer Effect}** - adjusts the number of repeats in the gradient. Layer Effect has a range of -100% to 100%. At the home value of 0%, one full gradient is shown. Moving toward 0%, you will see less of the gradient and moving toward 100%, you will see up to four repetitions of the gradient.



Note: *The button **{Layer Effect 2}** is for use with perlin noise effects.*

Using Rainbow Gradients

For Rainbow Gradients, the colors cannot be adjusted. But the number of repeats can be adjusted by using **{Layer Effect}**. **{Playback Mode 1}** and **{Playback Speed 1}** work in the same way as for two color gradients.

Using Perlin Noise

For perlin noise effects, there are different options for control:

- **{Playback Mode 1}** - basic animation of noise, forward or reverse.
- **{Playback Speed 1}** - speed of animation.
- **{Layer Effect}** - adjusts the amount of noise. -100% equals very little noise, and 100% equals a lot of noise.
- **{Layer Effect 2}** - adjusts the horizontal scrolling speed. -100% equals a fast left scroll, 0% equals no scrolling, and 100% equals a fast right scroll.

Pixel Mapping in a Multi-Console System

When using file based media in a multi-console environment, the primary console should be used as the 'base' media archive.

Media can be imported to the primary, and the backup console and/or any other clients can then synchronize their own, local media archives with the primary. The backup must synchronize media with the primary in the event that the backup must take control as the master. For clients, synchronizing the media is optional but useful if you wish to see the media playing back in the Pixel Map Preview display.

Steps for Configuring a Multi-Console System

Once the Eos Family Pixel Mapping Installer has been installed on all consoles, follow these steps to configure your multi-console system:

Setting up the Primary

- Step 1: On the primary console, exit to the Eos Configuration Utility (ECU).
- Step 2: Press the **{Settings}** button.
- Step 3: Press **{General}** if needed.
- Step 4: Make sure that the **{Share Media Archive}** box is checked. This will allow for sharing of the primary's media archive. Copy the path name, you will need it to setup the backup and/or client.

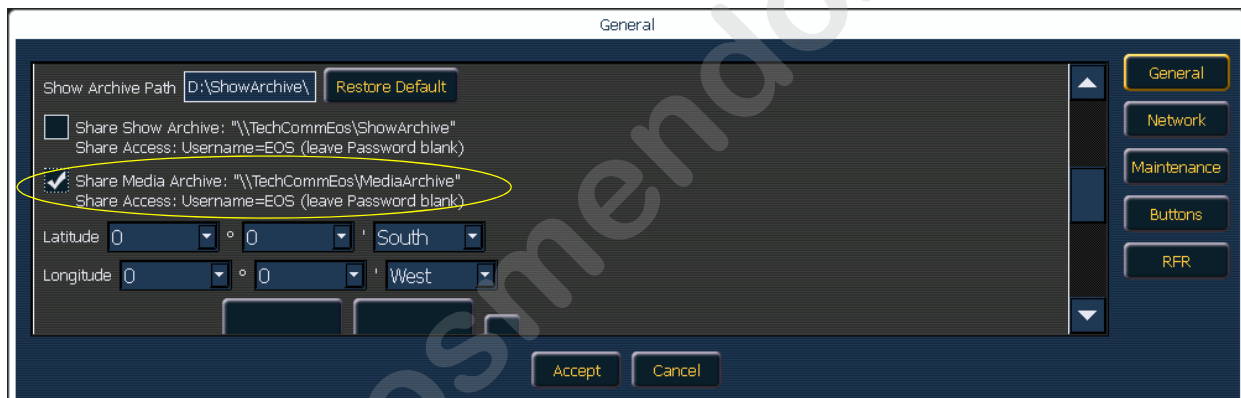

Setting up the Backup and Clients

- Step 5: On the backup or client, exit to the Eos Configuration Utility (ECU).
- Step 6: Press the **{Settings}** button.
- Step 7: Press **{Maintenance}**.
- Step 8: Press **{Network Drives}**.

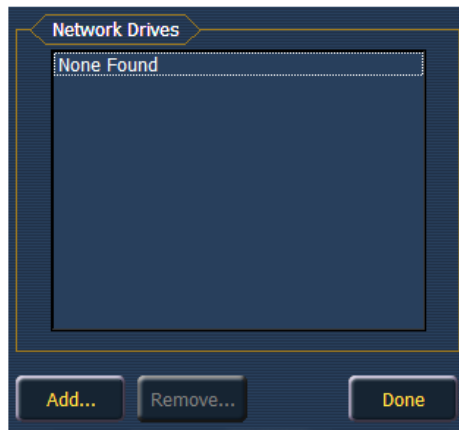

Step 9: In the Network Drives display, click the **{Add}** button.

Step 10: In the Add Network Drive display, choose a drive letter for **{Local Drive}**.

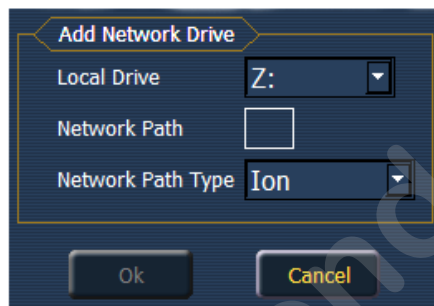

Step 11: Enter in the **{Network Path}**. The path name is listed next to the primary's **{Share Media Archive}** checkbox.

Step 12: Select the appropriate console type for the **{Network Path Type}**.

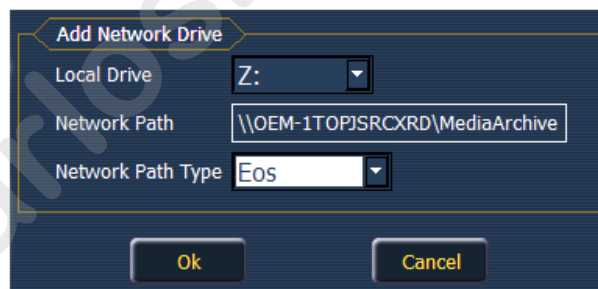

Step 13: Click **{Ok}**. You will now be able to access the primary's media archive from the backup or client. This new drive will appear in the browser like a USB drive.

Step 14: Click **{Done}** and launch the Ion application.

Synchronizing Media Archives

To view media playback in the Pixel Map Preview display, you will need to first import the required media into your backup and/or client's local media archive. This is done from the browser. There are two options for importing media:

- Import Show Pixel Map Media - This import function should be used by the backups and clients. It is the easiest way to ensure that your console will have all of the media required by

the current show file.

- Import All Pixel Map Media - This import function should be used by the primary to load the base media content and later to load media on the fly as required. This import function provides more complex options, like targeting which Library and File the media data will be imported into. See [“Importing Media Content” on page 312](#).

Steps for Synchronizing Show Pixel Map Media

Step 1: On the backup or client, navigate to the browser.

Step 2: Expand **File>Import>Import Pixel Map Media>Import Show Pixel Map Media**.

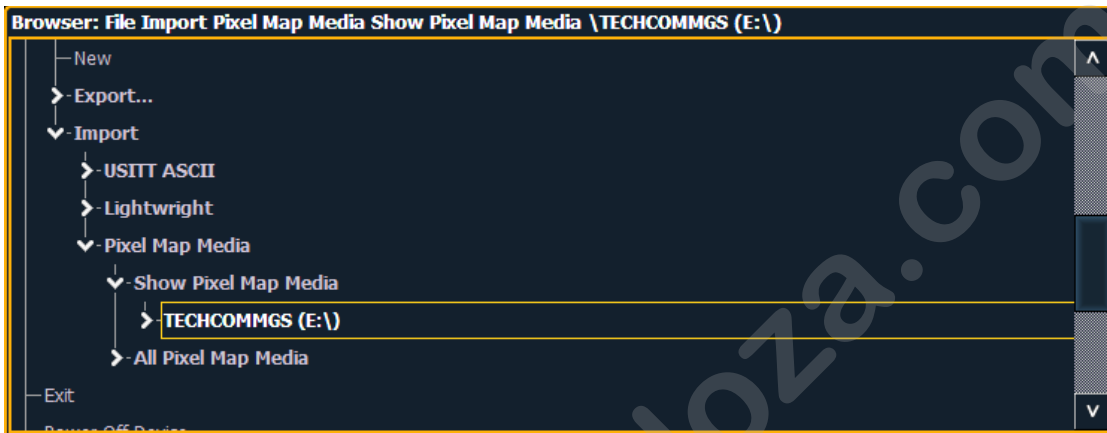

Step 3: Select the appropriate network drive.

Step 4: The Import Show Media display will open. Press the **{Start Import}** button.

Step 5: A progress bar will appear to indicate the status of the import process. When finished, click **{Done}**. You will now be able to see the media playing in the Pixel Map Preview display on the backup and/or clients.

Chapter 27

Multiple Users

Ion can be set to act as a separate user from other consoles on the Ion system, or it can be set to act as the same user as another console. This is done by changing the user ID.

This chapter contains the following sections:

- [About User ID](#)328
- [Assigning User ID](#)328

About User ID

When multiple users are on the Eos Family network, they can all act as one combined user, as all separate users, or any of the varying degrees between.

Any Ion console, RPU, Eos console, RVI or client PC can be a separate user on the Eos Family network. Certain Eos Family devices work well as independent users while others are intended to share a user ID with another device. For example, consoles and RPUs are likely candidates for working with a unique user ID while RVIs and client PCs can be useful sharing an ID with another device to track programming information from a second location.

Eos Family devices sharing User IDs will share certain data, while those with different IDs will not. Below are the differences in multi-console data depending on User ID.

Data shared between Eos Family devices with the same User ID

- command line
- null channels in live
- selected channels
- filters
- selected cue
- live/blind mode
- setup>desk settings

Data specific to the Eos Family device, regardless of User ID

- current slider page
- current encoder page
- focus on displays without command line
- display configuration (layout, format, visible parameters, flexichannel)
- paging without changing selected target or channels

Data identical between all Eos Family devices, regardless of User ID

- all stage levels and edits
- all data stored in the show file
- playback, sub and grandmaster contents and progress

The default User ID for any Eos Family device is 1. You may change this based on your preference to allow/restrict the functionality described above.

Assigning User ID

User ID can be defined in setup (see [{Displays}, page 107](#)).

When multiple programmers are working on an Ion system, partitioned control can be used to restrict a specific user's access to certain channels. This can help avoid overlapping control of channels by multiple programmers at once.

For more information on partitioned control, see [Using Partitioned Control, page 329](#).

Chapter 28

Using Partitioned Control

Partitioned control allows discrete control and programming of channels between multiple programmers. Partitions can restrict access to specific channels by a particular user.

This chapter contains the following sections:

- **About Partitioned Control** 330
- **Setting Up Partitioned Control** 330
- **Partition List** 330
- **Creating New Partitions** 331
- **Using Partitions** 332

About Partitioned Control

When multiple programmers are working on an Ion system, partitioned control can be used to restrict a specific user's access to certain channels. This can help avoid overlapping control of channels by multiple programmers at once.

Channels can be included in more than one partition.

Partitions only affect which channels a user has access to. They do not affect playback. As cue attributes are shared, in most instances programmers using different partitions will choose to store into different cue lists.

How to Use Partitions

The primary use of partitioned control is to allow more than one programmer to work on a show file at the same time without the risk of one user storing data for another user's partitioned channels.

The most common example of this situation is when one user is programming moving lights while another user programs conventional fixtures. Partitioned control allows these users to divide the channels between them so they may work simultaneously. If one user stores data using **[Record]** or **[Record Only]**, partitioned control will guarantee that only data for their partitioned channels will be stored. Data for channels not in the partition will be ignored when any store commands are performed.

Setting Up Partitioned Control

Partitioned control is enabled or disabled in show settings (see [Show Settings, page 96](#)). Partition defaults to "Disabled". Enabling or disabling partitioned control is a systemwide setting, so all consoles on the network will adhere to the setting.

Partition List

To view the partition list, click the **{Partitions}** button in Show Settings. This display lists all existing partitions. There are four pre-programmed partitions in Ion, they are:

- **Partition 0** - No channels and no fader control. This is the default for all users when partitioned control is enabled for the first time on a show. To gain control, you must select a different partition.
- **Partition 1** - All channels. Allows the user access to all channels.
- **Partition 2** - Single Parameter Channels. Allows the user access to only channels with a single parameter.
- **Partition 3** - Multiple Parameter Channels. Allows the user access to only channels with multiple parameters.

To select a partition in the list, enter it in the command line.

- **[Partition] [2] [Enter]**

If partitioned control is enabled, this will now be your assigned partition.

Creating New Partitions

To create a new partition, press:

- **{Partition} [x] [Enter]** - where “x” is a number that does not yet exist in the partition list.

This will create a new partition, highlight it in the list, and (if partition is enabled) assign it as your partition.

To assign channels to that partition, enter them in the command line:

- **[1] [Thru] [9] [6] [Enter]**

You can also use **[+]**, **[-]**, and **[Group]** to further modify the channels in the partition. When adding/subtracting channels to a partition, if you do not use **[+]** or **[-]** before channel numbers, the numbers will replace the channels in the partition, rather than adding to or subtracting from them. This overwriting does require a confirmation (if enabled in setup).

When you are finished, you can press **{Done}** to return to the setup screen.

Deleting Partitions

To delete any partition, simply type the syntax in the command line:

- **[Delete] {Partition} [5] [Enter] [Enter]** - deletes partition 5 from the list.

Preprogrammed partitions cannot be deleted.

Using Partitions

When partitions are enabled and a partition is selected, you may only record data for the channels included in the partition, with the exception of parking and unparking channel parameters or playing back cues. If you try to control a channel that is not in your partition, you must confirm that you want to control that channel. You will not, however, be able to store information for that channel.

If you select a range of channels and set them to a level and some of those channels are not included in the partition, you must confirm the command. After which, the command will be allowed on the channels not in the partition

When you record a target (cue, preset, palette), only those channels that are partitioned to you are recorded. Other programmers' record actions to the same target can add to it (they do not replace it) unless channels are shared. When shared, the last value provided at the point of the record action will be stored.

Partitions in Playback

In general, partitions do not affect playback. In Ion, how faders are configured and what is loaded to those faders is shared across all control devices.

When cues are played back from any console, regardless of partitions, that cue will be played back in its entirety. This ensures that while partitions are used, any user can activate a cue and all users will see that cue played back on the system.

To facilitate partitioned programming, Ion allows you to change the fader number of the master fader pair on any console. This allows you to have different cue lists on the master fader pair of any consoles on the network. Using this feature, programmers can work within their partitions, using the master fader pair for their specific cue list, without affecting the cue list that is loaded to the master fader of another console.

Flexichannel in Partitioned Control

When partitioning is enabled, a new flexi state, "Partitioned" is available as a softkey. When this is enabled, the flexi state is limited to only those channels defined in the current partition. This view may be further modified by use of the remaining flexi states.

Appendix A

Eos Configuration Utility

Overview

This appendix covers the Eos Configuration Utility (ECU) and its use. This is a component of the Eos Lighting Control System and is used for both system configuration and performing basic level test functions of your Ion desk. These instructions illustrate how to use the utility, but do not specify what changes to make as these are based on your preferences and can be changed to suit your control needs.



Ion uses the ECU for the same purposes as Eos. There is a section of the ECU dedicated solely to the Ion desk. It grants you the ability to configure the DMX, MIDI, contact closure, and relay ports on the back of the desk. For more information see [Local I/O, page 351](#).

What the Utility Does

Here is a brief list of some of the actions that can be performed from the ECU.

- Choose to boot the desk in Primary, Client, Backup or Offline mode
- Set the date, time and time zone
- Change the language the system uses
- Change the alphanumeric keyboard layout
- Configure external monitors
- Update software
- Configure Ethernet network settings and services
- Deep clear the system
- Save log files
- Perform a simple button and encoder response test
- Using the file manager

Eos Configuration Utility Reference

You can force the desk to boot into the utility instead of the main desk application. During the boot process, a countdown timer will appear. You will have 5 seconds to click the timer or to hold down “e”, “o” and “s” at the same time on the connected alphanumeric keyboard.

Otherwise, you can always enter the ECU from the Ion application by choosing **Browser>Exit**.

If you want the desk to always boot into the utility, make sure **{Open in Shell}** is checked. See [“Open in Shell” on page 337](#).

Starting Screen

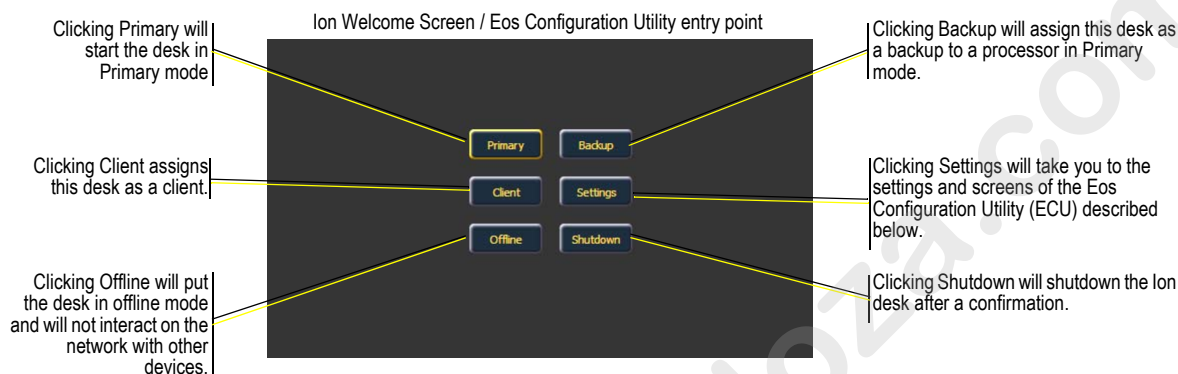

This is the starting screen of the utility. From here you can choose to boot the desk in one of several different modes, change various settings, or shutdown the desk.

Primary

This is the mode for using a single desk in non-networked or networked applications. On a system with multiple desks, the primary is the desk that client and backup desks synchronize with, making it the source of all information a client or backup desk sees on the network.

Primary mode can be run on Eos Ti, Eos, Gio, Ion and RPUs (Remote Processor Unit).

Backup

Backup mode requires a primary desk be online to synchronize. Once this is done, a backup desk intakes all show data for use in the event that it needs to assume control of the lighting system.

The main difference between backup and client modes is what happens in the event of primary processor failure. If the primary fails, a backup will ask if you want it to take control as the master of the system or if you want to troubleshoot the problem. You can set the backup to automatically take control. See [“Backup Automatically Takes Control” on page 343](#). When the primary remains in control, the backup will behave as a client would.

Backup mode can be run on Eos Ti, Eos, Gio, Ion, and RPUs. For more information on Ion backup systems, see [Multi-console and Synchronized Backup, page 357](#).

Client

A device set to client mode can act as a remote controller or remote video station for a system. A client device cannot output to the lighting system. Only a primary or backup processor can do this.

User ID determines some interaction between the client and the primary desk. If the client and the primary desk have the same User ID, they will act as one. If they have different User IDs, they will have separate command lines.

Client mode can run on Eos Ti, Eos, Gio, Ion, RPU, RVIs, and personal computers with the client dongle. Without a dongle, a client can connect in mirror mode. [See "Mirror Mode" on page 365.](#)



CAUTION: *ETC does not recommend the use of wireless for show critical functions.*

Offline

Offline mode puts the software in a state where there is no network activity, no control, no connections with other desks or any other network devices.

This mode is primarily intended for offline editing of a show file.

Offline mode can be run on Eos Ti, Eos, Gio, Ion, Element, RPU, RVIs, and personal desktop or portable computers.

General Settings



When you click on a field to change the entry, an appropriate keyboard (numbers only vs. full alphanumeric) will pop-up to provide a data-entry method even without a keyboard connected to the desk.

If you do have a USB keyboard attached, you can use either keyboard for the data-entry.



Device Name

This specifies the name the Ion desk will use to identify itself on the network to other devices. Examples might be Booth Desk and Tech Table.

Time

The time the desk is using. This can be set manually (direct data-entry) or via SNTP (Simple Network Time Protocol) time service. Please see [Network Settings, page 340](#) for more information.

The time is displayed in a 24-hour format as HH : MM : SS.

Date

The date the desk is using. This can be set manually (direct data-entry) or via SNTP (Simple Network Time Protocol) time service. Please see [Network Settings, page 340](#) for more information.

The time is displayed as MM / DD / YYYY.

Time Zone

The time zone the desk is using. This is an offset from Greenwich Mean Time (GMT). Each setting in the pull-down list displays the offset, the name of the time zone and a couple of cities in that time zone.

Language

Allows you to select the display language of Ion. Choices are English, Bulgarian, German, Spanish, French, Italian, Japanese, Korean, Russian, Chinese - simplified, and Chinese - traditional.

Keyboard

Allows you to select the language for the alphanumeric keyboard within Ion. A wide variety of keyboards are supported. The keyboard can also be changed in the application when the virtual keyboard is open.



Click on the flag icon to change the keyboard language.

Open in Shell

When this is checked, the Ion desk will boot into the Configuration Utility every time instead of booting directly into the main Ion application.

Automatically Update Software

When this is checked, the desk will receive software updates from the Primary if used in a multi-console system.

Show Archive Path

This is the default location to save show files. The full path must be typed in and specified in a legal Windows format. The default location is a folder on the D: drive.

If you decide to change this setting, it is recommended that you keep this location on the D: drive. This will keep show files safe during software updates that may include re-imaging the C: drive.

Share Show Archive

Checking this box will enable you to share the show archive folder on the desk with another desk or computer.

Share Media Archive

Checking this box will enable you to share the media archive folder on the desk with another desk.

Latitude

Allows you to select the latitude the desk is using.

Longitude

Allows you to select the longitude the desk is using.

Calibrate Elo External Touchscreens



Note:

Before you calibrate your external touchscreens, you may need to first use the External Monitor Arrangement display. See ["Monitor Arrangement" on page 338](#).

Allows you to calibrate an Elo touchscreen. With the touchscreen connected, press the **{Calibrate Elo External Touchscreen}**.

The first display will have you touch some targets, and the second will have you touch various parts of the display to make sure the cursor follows your finger. If that works fine, press the green checkbox. If you need to return to the previous display, press the blue arrow button. If your monitor requires additional calibration, see [Elo Touchscreen Settings, page 347](#).

Calibrate ETC External Touchscreens



Note: Before you calibrate your external touchscreens, you may need to first use the External Monitor Arrangement display. See “Monitor Arrangement” on page 338.

Allows you to calibrate an ETC touchscreen. With the touchscreen connected, press the **{Calibrate ETC External Touchscreen}**.

The first display will have you touch various parts of the display to make sure the cursor follows your finger and the second will have you touch some targets.

Monitor Arrangement

Ion allows for up to two monitors. The first time Ion boots with two monitors, it may not display output to both. You will need to configure the monitors in **{External Monitor Arrangement}** under **{General}** in the ECU.

The number on the monitors matches the number of the video port on the rear of the desk.

If monitor is displayed in gray, it is not currently enabled.

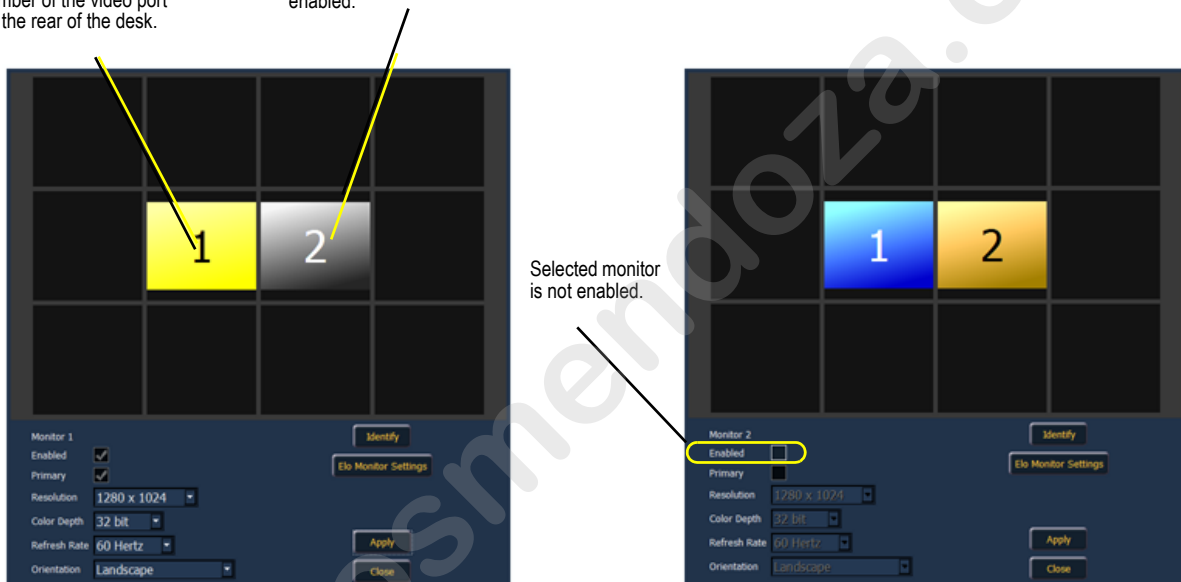

Note: The selected monitor will display in yellow. Monitors can be dragged to any of the surrounding black boxes to mimic actual monitor layout.

The Monitor Arrangement Tool will dictate how and where the pointer moves from one screen/monitor to another. Generally speaking, you will want the logical placement on this screen to match your physical placement.

Buttons available in the External Monitor Arrangement display are:

- **{Identify}** - displays the video port numbers that your monitors are connected to on the physical monitors to confirm where you have placed them.
- **{Enabled}** - When checked, the monitor is available for use. The desk will display the **{Enabled}** box checked for any monitors it recognizes.
- **{Elo Monitor Settings}** - See “Elo Touchscreen Settings” on page 347.
- **{Primary}** - selects which monitor will display the ECU and Central Information Area (CIA).
- **{Resolution}** - sets how many pixels the monitor will display.

- **{Color Depth}** - sets how many colors will be displayed.
- **{Refresh Rate}** - sets the number of times in a second the monitor refreshes.
- **{Orientation}** - sets the monitor layout.
- **{Apply}** - will save and use your settings. A window will open asking if you want to **{Keep Changes}** or **{Revert}** back to the defaults. **{Revert}** will be selected within 15 seconds if nothing else has been selected first.
- **{Close}** - will close the display. **{Close}** will not save any settings if **{Apply}** has not been used.



Note:

Only supported options will display. Monitor options may vary. While it is possible to assign a resolution lower than the minimum (1280x1024), it is recommended to be at 1280x1024 or higher.

Software Update

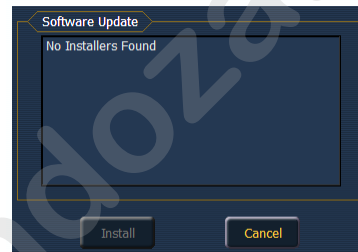
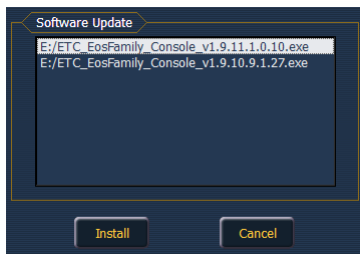

Software Update allows the installation of Eos Family Software and other ETC-approved software (GCE and NCE). Updating Eos Family Software does not affect or update the software in any other networked device such as a Net3 Gateway.

When you click on **{Software Update}**, the Ion desk looks at the root directory of any connected USB drive for an Ion desk software update file. You will be shown the names of any updater files found on the drive. Select the file you would like to install and click the **{Install}** button, or click **{Cancel}**. The software will first save to the hard drive before opening the installer.

You will also receive a message if no software update file can be found.

Network Settings

Console	Local Area Connection
Status	Online
Obtain an IP automatically	<input type="checkbox"/>
IP address	10.101.100.101
Subnet mask	255.255.0.0
Default gateway	10.101.100.101
Physical address	00-1c-c0-25-d3-5d
<input checked="" type="checkbox"/> Remote Startup	
<input checked="" type="checkbox"/> Remote Shutdown	
<input type="button" value="Ping..."/>	

Local Area Connection

These are the settings that determine the *method* to get an IP address and/or the *actual* IP address information that Ion uses for network communication.

Status

This reports if the port is “Online” (configured, connected to a network and operational). It reports as “Offline” if any one of the above conditions is not true.

Obtain an IP Automatically



Note: *ETC recommends the use of a static IP address for compatibility with other ETC devices, though the needs of your particular installation may vary.*

Clicking in the enable box will set Ion to get its IP address dynamically from a DHCP server. While the desk is starting, it will ask for an IP address from a DHCP server. If one responds, it will use the assigned IP address.

If no DHCP server is available, Ion will default to a self-generated link-local IP address in the range of 169.254.x.y. The IP address used by Ion in this configuration may change dynamically as needed. A change should typically only occur when there are changes to the network configuration or to resolve an IP address conflict.

Enabling or disabling the DHCP setting will require you to reboot Ion for the new setting to take affect.



Note: *You cannot set Ion to receive an IP address via DHCP and act as a DHCP server at the same time. It can either send dynamic addresses or receive them, but not both at the same time.*

IP Address

If DHCP is **disabled**, you set the Ion IP address here. This is a static IP address and will remain set until changed by a user. Ion defaults to an IP address of 10.101.100.101.

If DHCP is **enabled**, this field will display the IP address that is being used by the desk (whether it is served via DHCP or a self-generated link-local IP address).

Subnet Mask

If DHCP is **disabled**, you set the Ion subnet mask here. This is a static setting and will remain set until changed by a user. Ion's default subnet mask is 255.255.0.0.

If DHCP is **enabled**, this field will display the subnet mask that is being used by the desk (whether it is served via DHCP or a self-generated link-local IP address).

Gateway

If DHCP is **disabled**, you set the gateway IP address here. This is a static gateway IP address and will remain set until changed by a user. Ion's default gateway is 10.101.100.101.

If DHCP is **enabled**, this field will display the gateway IP address that is being used by the desk (whether it is served via DHCP or a self-generated link-local IP address).

Physical Address

The physical address is the MAC address. This address is a unique identifier and cannot be modified.

Enable Remote Power On/ Off

From Ion it is possible to remotely power on and off some devices, such as RPUs, RVIs, and other desks.

{Remote Power On} and **{Remote Power Off}** must be enabled on each device before it can receive the power on and off commands. The default setting for both is Disabled.

The Remote Power commands are sent from the browser. The command for Power On is sent from **Browser>Network>Power On MultiConsole System**, and the command for Power Off is from **Browser>Network>Power Off MultiConsole System**.



Note:

Only devices that synchronize with the Primary will be available for Remote Power On and Off.

Ping

Ping is used to test the network connection between two devices.



Output Protocols

This is for selecting which protocols the desk will output and which ones are included in the default.

Protocol	Enabled	Priority	Version	Subnet	Start	Universe
sACN	<input checked="" type="checkbox"/>	Priority: 100	Draft Version (v0.2)			
EDMX	<input type="checkbox"/>	Priority: 10				
AVAB UDP	<input type="checkbox"/>	HTP: 0	Directed Broadcast	Subnet: 0		
ArtNet	<input type="checkbox"/>	Directed Broadcast	Art-Net Start: 0		Sub-Net(0)	Universe(0)

Output to Visualizer from Offline
 Backup takes over at higher priority
 Backup automatically takes control

Allowed Output Addresses

From To
From To

sACN

This sets the control priority for sACN data from this desk. The valid range for this setting is 1 (lowest) to 200 (highest). This is the reverse of EDMX.

Ion and the Net3 Gateways support two versions of sACN, the draft version and the final ratified version. The ratified version is outputted by default unless this is selected.

Net2 - EDMX

This sets the control priority for EDMX data from this desk. The valid range for this setting is 20 (lowest) to 1 (highest). This is the reverse of sACN.

Avab UDP

This sets the subnet for Avab UDP data from this desk. The priority levels range from 0-200. The default is 0, which is no priority level. 1 is the lowest priority level and 200 is the highest. When set to no priority level (0), the data will merge according to HTP.

A backup desk will receive its Avab UDP priority level from the primary. The backup will then output at one priority higher than the primary, unless the primary was set to the highest priority of 200.

ArtNet

This sets the subnet for ArtNet data from this desk. The valid ArtNet Start range for this setting is 0-15.

Broadcast Type

- **Directed Broadcast** - Broadcast packets are directed to a subnet based on the IP address and subnet mask of the sender.
- **Limited Broadcast** - The limited broadcast address is 255.255.255.255. It is limited because routers will never forward datagrams with that destination address. This means that datagrams with the limited broadcast address are confined to the particular network segment on which they originate.

Output to Visualizer from Offline

Checking this box allows for output in offline mode for use with a visualization program.

Backup Takes Over At Higher Priority

This enables the backup device in a multiconsole system to take over at a higher priority than the master if the master goes offline.

Backup Automatically Takes Control

Switches to the backup automatically if the primary should go offline.

Allowed Output Addresses

A range or ranges of addresses that can be assigned to limit the number of output addresses. The default setting is to allow addresses 1 through 65536.

Interface Protocols

MultiConsole

Clicking in the enable box will allow for multiconsole communication on the selected port. See [“Multi-console and Synchronized Backup” on page 357](#).

Network Type

This setting adjusts the timeout period before a backup device will take control from the master.

- **Standard** - After five seconds of no response from the master, the backup will assume the master has disconnected and will then take control.
- **Engineered** - After 1.6 seconds of no response from the master, the backup will assume the master has disconnected and will then take control.

Sensor Feedback

Clicking in the enable box will allow Ion to receive feedback over the network from a Sensor rack. This option is “Enabled” by default. See [About Address, page 272](#) for more information.

RDM

Clicking in the enable box will allow Ion to perform RDM functionality including device discovery. See [{Patch} Display and Settings, page 76](#) and [About Address, page 272](#)



Note: *RDM requires use of a Net3 Gateway using version 5.1 or higher.*

FDX Feedback

Clicking in the enable box will allow Ion to receive FDX dimmer feedback over the network.

Broadcast Type

- **Directed Broadcast** - Broadcast packets are directed to a subnet based on the IP address and subnet mask of the sender.
- **Limited Broadcast** - The limited broadcast address is 255.255.255.255. It is limited because routers will never forward datagrams with that destination address. This means that datagrams with the limited broadcast address are confined to the particular network segment on which they originate.

WiFi Remote

Select to allow WiFi RFRs, like the iRFR or aRFR, to connect to Ion. For additional information, including setup, please visit the [iRFR Documentation Wiki](#) and [aRFR Documentation Wiki](#), www.etconnect.com/wiki.

UDP Strings

Clicking in the enable box will allow the selected port to send UDP strings.

DHCP Service

All settings in this section require a reboot of the desk before they will take effect. If this section is grayed out, or you are unable to change any settings, you don't have Net3 Services installed on your desk. Net3 Services are installed by the installer for ETC's Gateway Configuration Editor (GCE) software, which is available for download from the ETC website.

Ion can provide a DHCP (Dynamic Host Configuration Protocol) address server. DHCP is a TCP/IP protocol that dynamically assigns an IP address to a network device when it requests one.

This is a small and simple DHCP server that is intended to be used on non-routed networks. It will not serve IP addresses across a router.



CAUTION: *There should only be a single DHCP server active on a network. It is possible to start more than one DHCP server on a single network (nothing is built-in to DHCP servers to prevent this from happening). If this occurs, it will result in unstable conditions and possibly result in network communications failures.*

Clicking in the enable box will start the DHCP server in the Ion desk. It will use the settings below to determine which IP addresses it gives out.

- **First Address**- This sets the starting IP address of the range of IP addresses the DHCP server will give out.
- **Number of Addresses**- This sets how many IP addresses the DHCP server will give out. A setting of 500 means it will give out IP addresses to the first 500 devices that ask for an IP address.
- **Subnet Mask** - This sets the logical network size vs. the device address. ETC's default is 255.255.000.000 (class B). This is the subnet mask that the DHCP server will give to network devices.
- **Routed** - If checked, you can use the default gateway box, below, to specify the gateway you would like DHCP devices to use. If unchecked, the DHCP server will serve the same value for both the devices IP address and gateway, which is a suitable configuration for non-routed networks.
- **Default IP Gateway**- This specifies the IP address of a router if one is present on your network. This is the gateway IP address that the DHCP server will send to network devices to use.
If you are on a flat or non-routed network, the Gateway IP address should match the IP address of the device. In order to configure this DHCP server to send out matching gateway IP addresses, **configure this gateway IP address to match the IP Address Pool field**. Then the DHCP server will give out a gateway IP address that matches the IP address.

Learn Network Devices

Clicking this button will trigger the DHCP service to search the network for existing devices, and add them to its table of known addresses. If you have equipment with statically assigned IP addresses in your network, this will ensure the DHCP service does not serve out any IP addresses which conflict with those devices.

Update Service (TFTP)

Clicking in the enable box will start the TFTP (Trivial File Transfer Protocol) server.

- **Update File Path** - This sets the directory where files are to be served through TFTP. This must be the full path to the directory, including drive letter. For example: C:\etc\nodesbin

Time Service (SNTP)

Clicking in the enable box will start the SNTP (Simple Network Time Protocol) service. You determine if the service is running as a client (receiving time messages) or as a server (sending time messages) during the installation process.

- **Client/ Server** - When configured as a client, a desk will attempt to synchronize its time with the rest of the devices in the system, by listening for time information and altering its own clock. When configured as a server, a desk will serve out time to other devices on the network, acting as a time “master”
- **ETC Net2 time** - With ETC Net2 time enabled, the time server will periodically broadcast (as a server) or receive (as a client) the current time, which is required by devices running the ETCNet2 protocol, for example, Legacy Unison systems.
- **External Time Server** - The External Time Server option allows you to synchronize your desk to a third party time system at a specific IP address using the NTP or SNTP protocols. This allows use of a specific time clock for time sync. This requires a high accuracy time clock on your network.
- **External Server IP** - If External Time Server is enabled, you will need to specify the IP address of your external NTP or SNTP time server in this field.

Maintenance and Diagnostics



Deep Clear

{**Deep Clear...**} functions in much the same way that **New** does from the File menu or **Reset System** does from the Clear menu (both are found within the browser). A deep clear is automatically performed when new software is installed. Sometimes it is useful to perform a deep clear between updates.

The advantage of deep clear is that you can clear all desk data before reloading the desk's current state during boot. This is helpful if you are moving a new desk onto the network and don't want it to suddenly take control of a system or if you somehow end up with a corrupt show file that is causing issues upon boot.

It's worth noting that Deep Clear (like **Reset System** and **File>New**) does not reset any of the settings in the Eos Configuration Utility (ECU) like its operational mode or IP address settings. Everything in the ECU remains as it was last configured.

Save Logs...

Clicking on the **{Save Logs...}** button displays a dialog box prompting you to save the desk log files for troubleshooting purposes. By clicking on the **{Advanced}** button, you can select or deselect any of the various individual log files to be saved.

Clicking **{Next}** you will see a drop down menu to select the target export location from any available write-enabled removable media such as a USB drive.

If you experience software problems with your system that we are unable to reproduce, sending these log files to ETC Technical Services (see [Help from ETC Technical Services, page 3](#)) can help us isolate the issue.

Backup Show Archive

{Backup Show Archive...} allows you to either backup the most current version of each show file or every version of each file to a USB drive.

Restore Show Archive

{Restore Show Archive...} allows you to restore show files from a USB drive.

File Manager

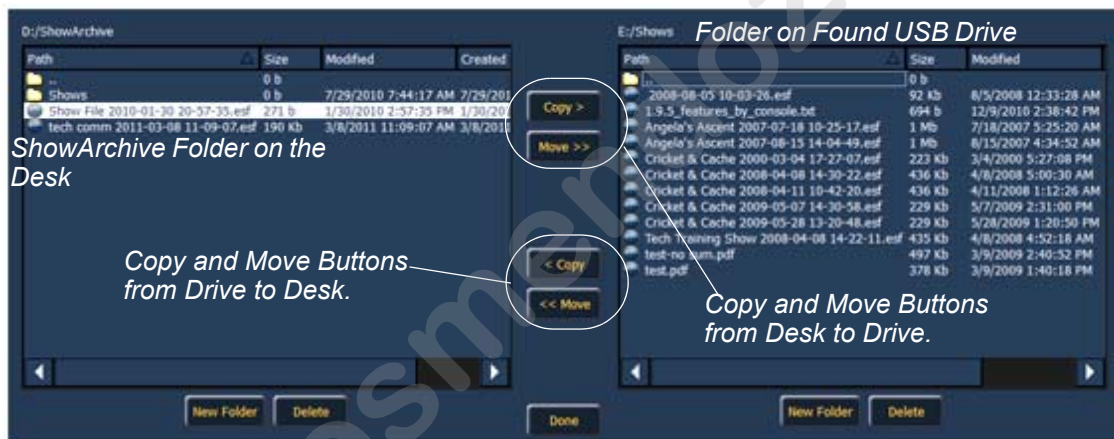

{File Manager} provides a way to manage show files. You can create and delete new folders, move, and copy files between the desk and USB drives.

The file manager display will show the ShowArchive folder on your desk as well as any external USB drives that are detected. The display is split into two windows, so you can see two different folders at the same time for copying or moving data between them.

Elo Touchscreen Settings

For basic calibration of your Elo touchscreen, see [Calibrate Elo External Touchscreens, page 337](#). For advanced calibration and settings, use the **{Elo Touchscreen Settings}** button.

Pressing **{Elo Touchscreen Settings}** will open the properties window for the monitor. This window has 5 tabs: general, mode, sound, properties 1, and about.

Upgrade Console

{Upgrade Console...} is used for upgrading the desk's outputs.

Upgrade I/O Firmware

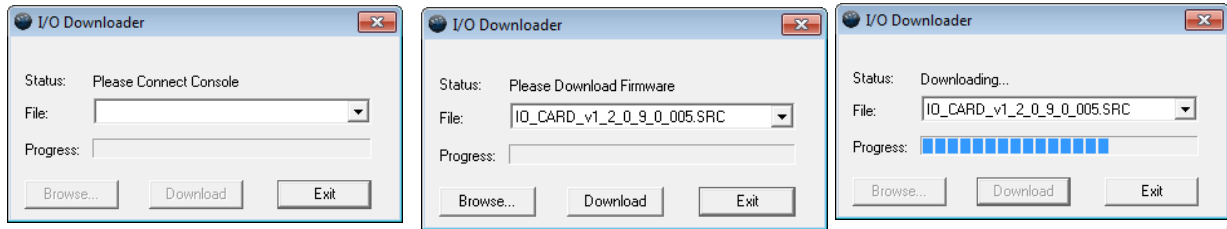

{Upgrade I/O Firmware} is used to upgrade the firmware in the desk's I/O card. When you first open the I/O Downloader, it will look for the connected console. This may take a second or two.

Once the console is found, the downloader will search for the needed files. If it finds the file, it will list it and you can click **{Download}**. If it doesn't find the file, you can use **{Browse}** to look for the needed file and selected it. Once finished, click **{Exit}**.

Network Drives

{Network Drives...} allows you to select an alternative show file storage location on another desk or computer. After setting this location, it will appear as an option within the save and open dialogs in Ion.

In the **{Network Drives...}** dialog box, there is a **{Add}** button for mapping a network drive. In the Add Network Drive dialog box, select the drive letter that is appropriate, the network path, and the path type. The network path can use either the IP Address or the Device Name. (Example: \\10.101.90.101\ShowArchive or \\YourDeviceName\ShowArchive) The network path type can be Eos, Gio, Ion, Element, Eos Ti, or Other. If Other is selected, you will have additional fields to fill out for Username and Password.

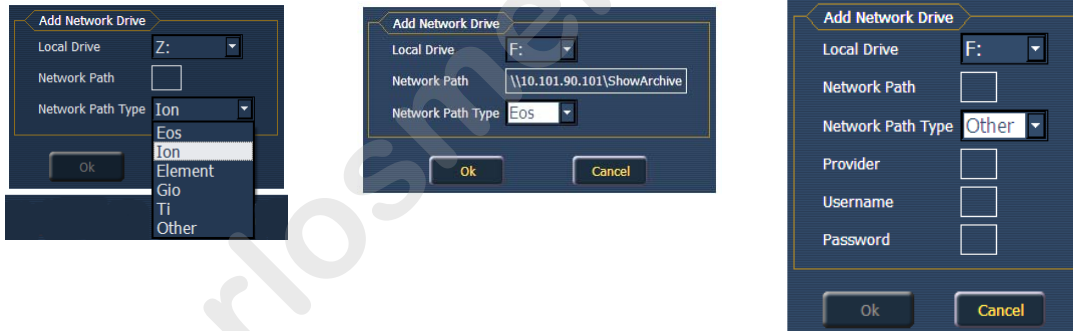

Shared Folders

{Shared Folders...} allows you to see if any folders are currently being shared by the desk. You can select the folder and click **{Don't Share}** if you no longer want to share the folder. By selecting **{Don't Share}** here, you will also uncheck the box for Share Show Archive in the General tab.

Log Off

This will log off the current user. This should only be done under the direction of ETC Technical Services for administrative purposes.

Firmware Update

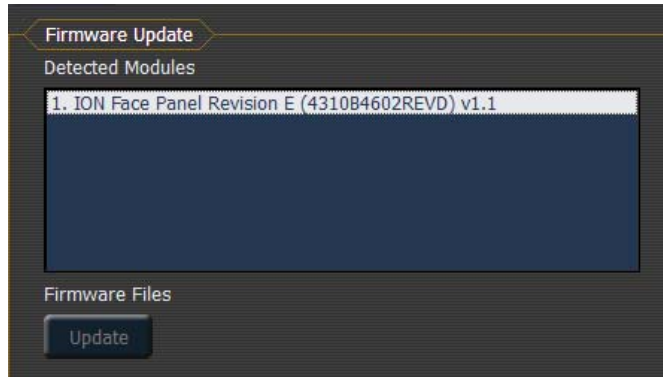

The firmware update window will display any detected devices that use firmware and may require an update. With the device selected, if an update is available, the **{Update}** button will be highlighted in yellow. If the button is grayed out, an update is not available

Face Panel Test

Face Panel Test provides a way to verify the functional state of all of the keys, encoders and sliders on the Ion desk. The screens are very straightforward. For field diagnostics, you shouldn't need more than the sections of Ion Keyboard.

Press/move every key and verify that those events register on the diagnostic test screen.

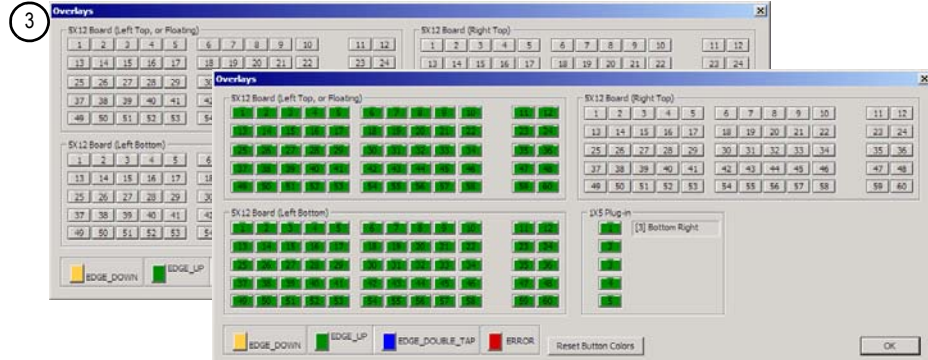
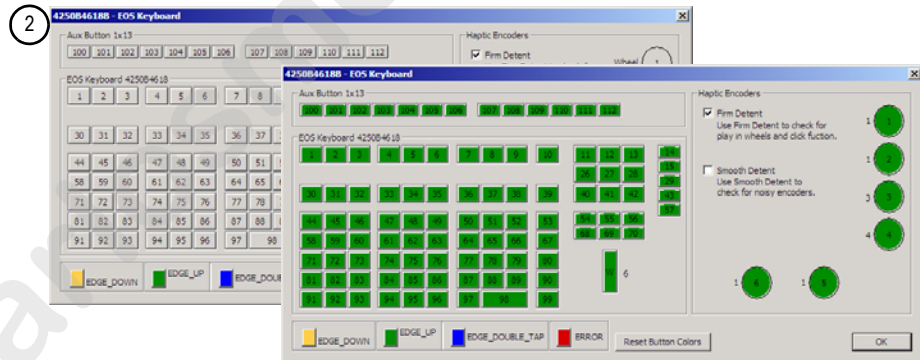
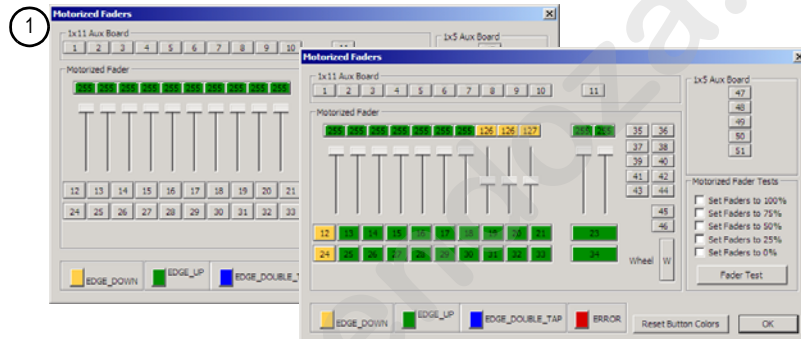
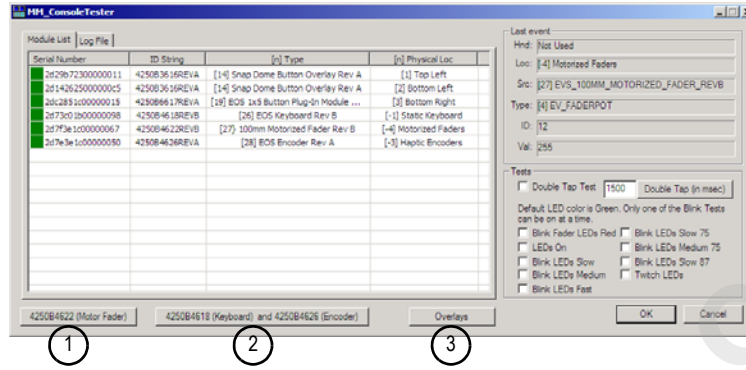

Buttons

RPU Face Panel Buttons

This area is for configuring the buttons on the front of a RPU or RVI. Clicking on a button will open a dialog window for selecting what type of button, macro, hardkey, or none, you wish to assign.

If hardkey is selected, a list of the various hardkeys on your desk will be available to select from. If macro is selected, a list of available macros will display. Selecting none will assign no action to the selected button.

{Import} allows you to import a RPU/RVI button configuration file. **{Export}** allows you to export a RPU/RVI button configuration file. **{Restore Defaults}** will restore the factory defaults for the RPU/RVI buttons.

For more information, [See "Software Configuration" on page 370.](#)

Local I/O

This screen allows you to configure the ports on the back of the Ion desk.

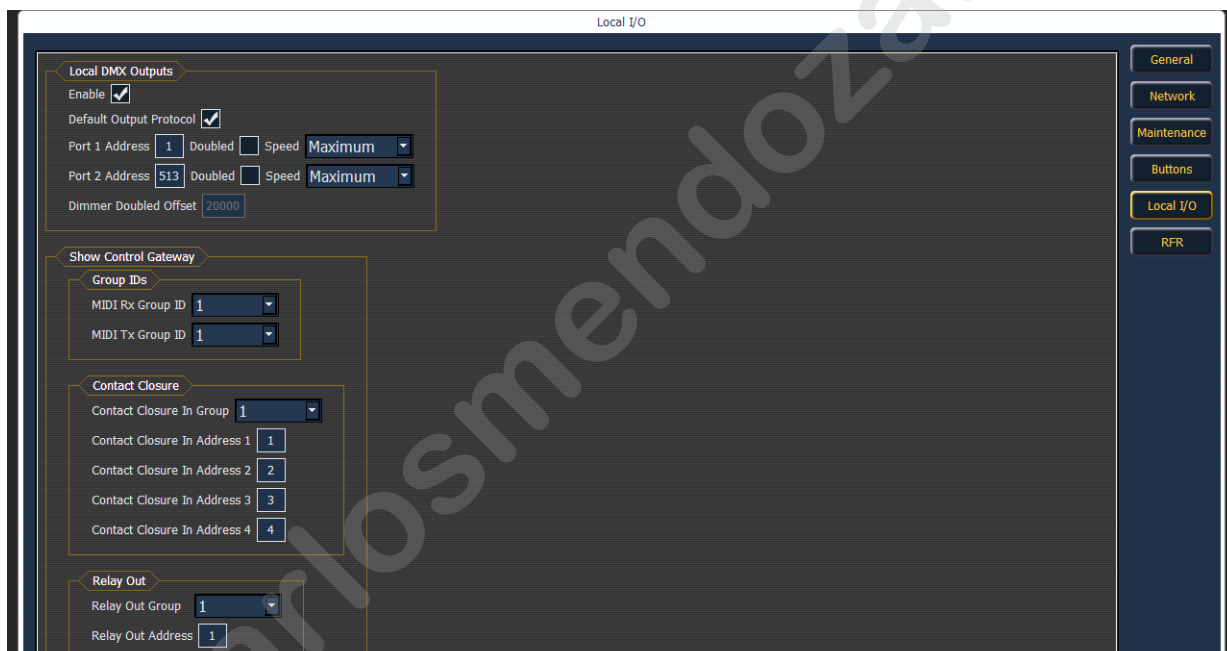

Local DMX Outputs

The following settings are available:

- **Enable** - enables DMX output from the local ports.
- **Default Output Protocol** - enables DMX as a default output.
- **Ports** - the settings for the two DMX ports.
 - **Address** - sets the starting address for the port.
 - **Doubled** - enables dimmer doubling on the port.
 - **Speed** - sets the speed for the ports. Options are: maximum, fast, medium, and slow. The speed may need to be adjusted for certain devices. The default speed is maximum.
- **Dimmer Doubled Offset** - this offset matches the default offset in CEM+ / CEM3 when configuring your Sensor dimmer rack for dimmer doubling. The default offset is 20,000.

Show Control Gateway



Note: To input RS-232 into an Ion desk, you will need to use a Net3 I/O Gateway.

Group IDs

Allows you to set the group number for the MIDI In and MIDI Out ports. Group numbers can be from 1-32. Default for both ports is 1.

Contact Closure (remote trigger connector)

Allows you to set the Group and Address In values for the remote trigger input on the back of Ion.

Relay Out (remote trigger connector)

Allows you to set the Group and Address In values for the remote trigger port on the back of Ion.

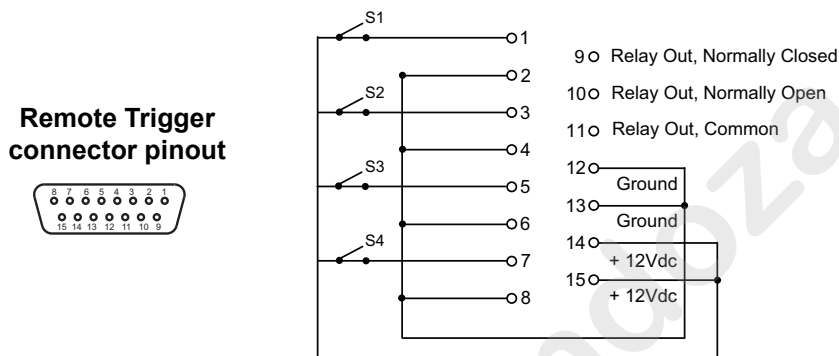

RFR

This screen is used for setting up the Radio Focus Remote (RFR) to work with Ion. For more information on RFR, see [Remote Control, page 377](#) For additional RFR settings, see [{RFR Settings}, page 109](#).

USB RFR Settings

These settings need to match between the desk and the RFR. For more information on changing the frequency and ID at the remote, see [Change Frequency and ID Setting, page 380](#).

High Frequency Channel

The frequency that the RFR is using. There are 1-12 channels.

Network ID

The Network ID is a separate digital channel on a single high frequency (HF) setting. There are 1-99 IDs available.

Appendix B

Facepanel Shortcuts

Overview

The following is a list of button pushes: single, maintained, or combined. It is highly recommended that you read and familiarize yourself with this list. For keyboard shortcuts, see the Eos Family v2.0 Hot Keys Quick Guide.

Facepanel and Displays

- **[Shift] & [Escape]** - locks and unlocks facepanel.
- **[Escape] & [Encoder Page Button]** - locks the encoders. Pressing any encoder page button unlocks.
- **[Encoder Page Keys] & [Number]** - pages to the desired encoder control page.
- **[Shift] & [Tab]** - closes all tabs except Live/Blind and the Playback Status display.
- **[Shift] & [Live/Blind]** - advances the displays to the next instance of live or blind.
- **[Live]** - when already in live, resyncs the selected cue to the most recently activated cue.
- **[Blind]** - when already in blind, resyncs to the active cue in live. (When blind cue has been changed, or when preserve blind cue has been enabled.)
- **[Flexi] & [Time]** - invokes flexi time view on displays.
- **[Flexi] & [Encoder Paging Keys]** - invokes flexi encoder states.
- **[Shift] & [Label]** (maintained press) - toggles the display between default view of referenced data and alternate view. Keep **[Shift]** depressed to page.
- **[Time]** (maintained press) - toggles the display to show discrete timing. Keep **[Time]** depressed to page.
- **[Data] & [Encoder Paging Keys]** - to expand/ suppress categories on displays.
- **[Displays] & Level Wheel** - dims the Littlites.
- **[Displays] [Displays]** - resets the CIA to the browser. (Unless another display is set to the favorite.)
- **[Data]** (maintained press) - toggles the display to show data living under referenced data. Keep **[Data]** depressed to page.
- **[Format] & Level Wheel** - zooms the display in focus.
- **[Shift] & [Load]** - removes content from a fader. Press again to unmap.
- **[Fader Controls] & [Bump Button]** - select a fader page on wings.
- **[Shift] & [Select]** - resets display columns.
- **[Shift] & [Up], [Shift] & [Down], [Shift] & Level Wheel** - resizes columns.
- **[Shift] & [Left], [Shift] & [Right]** - moves columns.

Operations

- **[At] [Enter]** - removes move information from selected channel/parameters. If done in live, posts the value from the previous cue (numeric) manually. If done in blind, allows the value from the previous cue to track in.
- **[Sneak] [Sneak]** - releases NPs of selected channels and self terminates.
- **[At] [At]** - set to level as defined in setup.
- **[Full] [Full]** - sets selected channels intensity to full and self terminates.
- **[Thru] [Thru]** - The **[Thru]** command accesses only the channels displayed in the current flexistate (unless the channel range specified is NOT in the current display). **[Thru] [Thru]** selects the range regardless of the flexi mode.
- **[Undo]** - clears an unterminated command line. Otherwise opens the undo controls.
- **[Shift] & [Clear]** - clears the command line.
- **[Copy To] [Copy To]** - posts 'move to' to the command line.
- **[Shift] & [Sneak]** - makes manual data "unmanual". It leaves the values as they are, but they are then no longer available for update or record only operations. When executed from an empty command line, this affects all manual data. When done with a channel selection, this affects only those channels.
- **[Shift] & [Full]** - flash on.
- **[Shift] & [Out]** - flash out.
- **[Shift] & [+]** - +%
- **[Shift] & [-]** - -%
- **[Shift] & [Update]** - shortcut to save.
- **[Timing Disable] & [Go]** - cuts the next cue.
- **[Timing Disable] & [Back]** - cuts the last cue.
- **[Recall From] [Recall From]** - posts recall from cue to the command line.
- **[Select Last] [Select Last]** - repeats last command line, unterminated.
- **[Shift] & [Last]** - repeats last command line, unterminated.
- **[Shift] & [At]** - recalls last channel(s) and parameters.
- **[Select Active] [Select Active]** - select active minus submaster contributions.
- **[Shift] & [Select Active]** - posts 'select non-sub active' on the command line.
- **[Shift] & [Select Last]** - posts additional channel selection options to the softkeys.
- **[Update] & [Bump Button]** - to update a specific submaster.
- **[Label] [Label]** - appended to a record target command, clears the current label, this includes show file labels.
- **[Shift] & restore manual channel faders** - resets faders to zero without asserting control.
- **[Shift] & [Delay]** - posts follow.
- **[Shift] & [Delay] [Delay]** - posts hang.
- **[Trace] [Trace]** - forces a previously inactive light to track its new intensity setting backwards.
- **[Shift] & [Encoder Page Key]** - posts the category to the command line

- **[Record] [Record]** - posts 'record only' to the command line.
- **[Shift] & [Fader Page]** – decrements the fader page by 1.
- **[Shift] & encoder toggle** - posts the parameter to the command line.
- **[Shift] & [Block]** - posts Intensity Block to the command line

www.carlosmendoza.com.mx

Appendix C

Multi-console and Synchronized Backup

Overview

This appendix outlines the procedures required to use multiple Eos Family control devices (such as an Ion console, Eos Ti console, Eos console, Gio console, Remote Processor Unit (RPU), Remote Video Interface (RVI), or PC or Mac with client dongle) simultaneously on a network. It outlines the setup, configuration, and behavior that is entailed in an Ion multi-console scenario.



Note: *Only Intel-based Macs can connect as a client. A Mac client will not support any external ETC USB devices, such as fader wings or the RFR. A Mac client will support use of the iRFR.*

Ion multi-console functionality is also used to provide synchronized backup of your show while running multiple Ion devices on the network.

Definition of terms

Familiarize yourself with these terms prior to setting up a multi-console system.



Note: *Ion consoles, Eos consoles, Gio console, RVIs, RPUs, or a computer running Eos with a client dongle may all be considered active units on an Ion network. For the sake of brevity, the term "Ion" is used to represent any and all of these options in the following descriptions.*

- **Primary** - When an Ion is configured as a primary, other Ion devices can connect and synchronize with it. If using a backup processor, the primary is the Ion that will be backed up. Only Ion/Eos/Eos Ti/Gio consoles and RPUs can be set to primary. By default, all Ion consoles will start up as a primary.
- **Backup** - This Ion is capable of taking control of the system if the primary fails. You may input data and run your show from a backup. There can only be one backup in an Ion network and you must specify which primary it is backing up. Only Ion/Eos/Eos Ti/Gio and RPUs can be set to backup.
- **Client** - Any online Ion that is not the primary or backup is a client. Client data is sent and received over the network, and clients will synchronize with a designated primary.
- **Offline** - Any Ion controller that is disconnected from the Ion network. Changes to show data performed on an offline Ion will not affect the rest of the Ion network or the lighting system.
- **Master** - The Ion that is currently sending control data to the lighting system is the master. In most circumstances this is also the primary. Should a primary fail and a backup takes control, then the backup will be acting as the master.
- **Tracking** - Any console that is synchronized with a master is tracking. Once a backup takes control it becomes a master and is no longer tracking.

- **User** - A user is an Ion defined by a user ID. If it has a unique user ID, the Ion will operate separate from other Ion devices on the network, but would still track show data. If it shares a user ID, Ion will synchronize with like IDs. See [User ID and multi-console features, page 360](#).
- **System** - One primary Ion, one backup Ion, and (if available) multiple clients synchronized together.
- **Mirror Mode** - A mode for mirroring the displays of another device. See [“Mirror Mode” on page 365](#).

Multi-console setup

When using multiple Ion consoles on the network, you should adjust some of the settings of your devices to ensure optimal functionality.

Additional requirements for multi-console setup include:

- Software versions must match exactly between all devices.
- The language settings in the ECU must match. See [“Language” on page 336](#).
- The keyboard language setting in the ECU must match. See [“Keyboard” on page 337](#).



Note:

*It is recommended that you perform the following setting changes **before** connecting your Ion device(s) to the network. After the changes are complete, connect to the network and reboot the device.*

Designate Primary

By default, all Ion devices will boot as a primary. When using multiple devices on the network, only one should be designated as a primary. Other devices should be configured as the backup (only one per system) or clients. There can be a maximum of 12 Ion devices connected to a master.

To change this setting, you must exit the Ion software (**Browser>Exit Ion**) and then designate the device as primary, backup, or client as described in the ECU appendix (see [Starting Screen, page 334](#)).

DHCP Server

DHCP server supplies IP addresses to network devices. Only one Ion device [typically the Primary] on the network is necessary to do this properly. Therefore you should disable the DHCP server on all devices except for the intended primary.

To disable the DHCP server on your device see [Local Area Connection, page 340](#).

Change Device Name

To easily identify your Ion on the network, change the device name to be representative of the device (such as “Booth Primary” or “Tech Backup”). This is done in [General Settings, page 336](#).

Backup Auto Switch

Switches to the backup automatically if the primary should go offline. This is enabled in [Backup Automatically Takes Control, page 343](#).

Backup at Higher Priority

This enables the backup device in a multi-console system to take over at one priority higher than the master if the master goes offline. This is enabled in [Backup Takes Over At Higher Priority, page 342](#).

Network Type

This setting adjusts the timeout period before a backup device will take control from the master.

- **Standard** - After five seconds of no response from the master, the backup will assume the master has disconnected and will then take control.
- **Engineered** - After 1.6 seconds of no response from the master, the backup will assume the master has disconnected and will then take control.

Change IP Address

All Ion consoles by default have the same static IP address. All Ion RPUs also, by default, have the same static IP address. A full list of ETC network IP address is available at www.etcconnect.com/wiki.

Default Ion Console IP Address: 10.101.100.101

Default Ion RPU IP Address: 10.101.95.101

Each Ion device on the network should be given a unique IP address. If running multiple devices of the same type (for example - two consoles, or two RPUs), you must alter the default static IP addresses to ensure proper functionality.

Changing the static IP address is done through the ECU (see [Network Settings, page 340](#)), on the “Network” page. Manually change the IP address of any non-primary Ion device by clicking in the IP Address field and entering the new number from the keyboard. When done, press **[Enter]**.

Console	Local Area Connection
Status	Online
Obtain an IP automatically	<input type="checkbox"/>
IP address	10.101.100.101
Subnet mask	255.255.0.0
Default gateway	10.101.100.101
Physical address	00-1c-c0-25-d3-5d
<input checked="" type="checkbox"/> Remote Startup	
<input checked="" type="checkbox"/> Remote Shutdown	
Ping...	



Note:

It is recommended that you alter the very last digit of the static IP address by an increment of one for each additional Ion device on the network. Therefore, if the master ends in “101”, change the backup to end in “102”, a client to end in “103” and so on.

User ID and multi-console features

Set in Setup (see [{Displays}, page 107](#)), User ID is an Ion/Eos-specific identifier that can be set uniquely for each Ion device or can be shared between multiple devices allowing for shared data between consoles. The user ID can be set anywhere from 1 to 99.

Ion devices sharing User IDs will share certain data, while those with different IDs will not. Below are the differences in multi-console data depending on User ID.

Data shared between Ion devices with the same User ID

- Command line
- Null channels in live
- Selected channels
- Filters
- Selected cue
- Live/blind mode
- Setup>desk settings

Data specific to the Ion device, regardless of User ID

- Current slider page
- Current encoder page
- Focus on displays without command line
- Display configuration (layout, format, visible parameters, flexichannel)
- Paging without changing selected target or channels

Data identical between all Ion devices, regardless of User ID

- All stage levels and edits
- All data stored in the show file
- Playback, submaster, and grandmaster contents and progress

The default User ID for any Ion device is 1. You may change this based on your preference to allow or restrict the functionality described above.



Note:

After you have completed the setting changes described above, connect your Ion device to the network and reboot the device.

Multi-console backup

Within an Ion system, you have the added bonus of show data backup. The backup on the system will receive all show data updates and stage levels so that, in the event of a primary failure, the backup will be capable of taking control of the system without a loss of show data or live output. Saving occurs across the whole network.

Synchronized Backup

Once you have changed settings to facilitate a multi-console system on the network, you may activate synchronized backup to ensure show data security.

Ion synchronized backup is designed so that during normal operation the primary console controls the lighting system and any console configured as backup or client synchronize with the primary. The following activities will synchronize between consoles when operating in a backup system:

- Playback
- Record operations
- Manually set data
- Show file and show data

Only Ion, EosTi, Eos, and Gio consoles, or RPUs can function as a primary or backup.

Setting up Synchronized Backup

Before backup is possible, you must have at least two Ion devices (consoles or RPUs only) connected to the network. One must be assigned as primary and one as a backup.

To assign a backup to a primary:

- Step 1: Exit the Ion environment (**Browser>Exit**) on the console you wish to act as the backup. This will send you to the ECU welcome screen.
- Step 2: Click on the **{Backup}** button in the welcome screen. The console will then startup the software, this time in backup mode. Ion will try to connect to a master console. The CIA will say “Waiting for Master. One moment please...”.
- Step 3: If the backup doesn't connect after a few moments, click the **{Troubleshoot}** button in the CIA. This will open the network configure screen in the CIA.



Note:

*If this is the first time that a backup is connecting to this master, you will need to press **{Troubleshoot}** and select the master.*

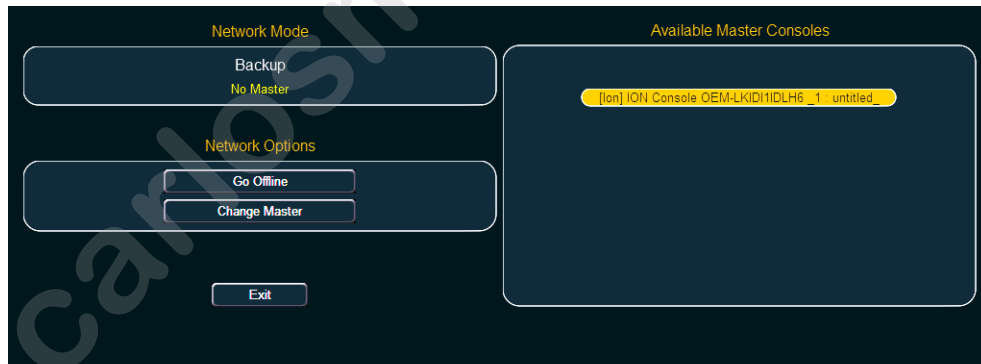

Step 4: Select a master console from the list on the right. If no masters are available in the list, a master console is not connected to the network.

Step 5: Press **{Change Master}**. The backup Ion will synchronize with the master.



In the CIA you will see the current status of the backup.

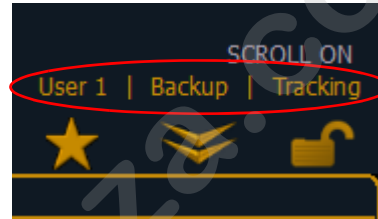
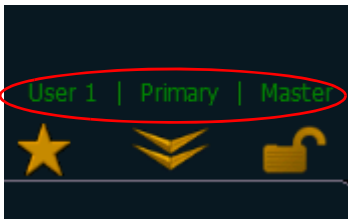

If the primary goes offline for any reason, the backup will automatically takeover as the master if backup auto switch has been enabled, [See “Backup Automatically Takes Control” on page 343.](#) Whenever master control changes between the primary and the backup, there will be a dialog window that will be displayed that much be dismissed by the user.

When master control moves between the primary and backup devices, any clients in the system will automatically connect to the current master. Clients will also display a message, but the message will be dismissed after a short period of time. The device status above the CIA will also change.



Note:

A client may take up to 30 seconds to determine that connection with the master has been lost.

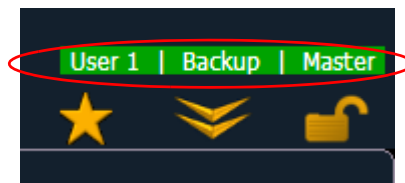
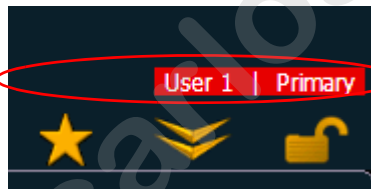

If you enter the **Network>Configure** screen, it will have changed to the following.



Your backup is now acting as the master and is controlling the lighting system.



Note:

*If the primary comes back online, it will **not** retake control of the lighting system. The primary will wait until it is redesignated as the master and the backup is reassigned to it.*

*You can force the backup to release control back to the primary by going to **Browser>Network>Configuration** and pressing the **{Release Control}** button.*

*You can also force the primary to take control away from a backup by going to **Browser>Network>Configuration** and pressing the **{Take Control}** button.*

Backup Scenarios

Console and console

Two consoles can be used to provide backup. Either can be configured as the primary or the backup. If the primary console fails, the second console will take control with full show data intact.

This is a useful scenario for touring multi-user applications.

RPU and console

One RPU and one console can be used as a backup option. In this configuration, it is recommended that you set the RPU as the primary and the console as the backup. In this scenario, should the RPU go offline, you will still have the full functionality of the console user-interface at your disposal.

RPU and RPU

Two RPUs may serve as primary and backup also. A backup system of this type can support many client consoles at once, which you may turn on and off as needed without the need to reset to a different master each time.

This application is ideal for permanent installations requiring synchronized backup.

Remote Software Installation

Within a multi-console system, you can now remotely install software to all devices.



Note: *All devices **must** be upgraded to version 1.9 before remote software installation is available.*

In the ECU, go to **Setting> General> Automatically Update Software** to enable. Once enabled, the devices can be remotely updated with the next version of software. Devices will receive the software update from the Primary. When you install software on the Primary, the software will first be copied to its hard drive.

With the devices synchronized with the Primary, install the new version of software onto the Primary. All devices will lose their connection with the Primary at that time. When the Primary comes back online after installing the software, all the connected devices will be forced to update their software before they can reconnect with the Primary.

Remote Power On/Off

In a multi-console system, it is possible to power on and off devices remotely. Remote Power On and Remote Power Off must be enabled on each device before it can receive the power on and off commands. In the ECU go to **Settings> Network> Enable Remote Power Off and Enable Remote Power On**. The default setting for both is “Disabled”.



Note: *Eos desks cannot be remotely powered on.*

The Remote Power commands are sent from the browser. The command for Power On is sent from **Browser> Network> Power On MultiConsole System**, and the command for Power Off is from **Browser> Network> Power Off MultiConsole System**.



Note: *Only devices that synchronize with the Primary will be available for Remote Power On and Off.*

Mirror Mode

Mirror Mode is used to mirror the displays of another device. When a device is in mirror mode, the only action allowed from that device is paging via the page keys and shut down/start up. When a device in mirror mode pages, it also pages the host.

Mirror mode is intended primarily to allow a designer or assistant to see the exact same displays as a programmer on the system. It can be used on any device on the network, including the primary processor. Any device being mirrored is referred to as the Host.

There is no limit to the number of mirrored devices a host can have. But a console currently in mirror mode cannot be mirrored.

Using Mirror Mode on a Client without a Dongle

A client without a dongle can connect to the network. When this is done, the client can only operate in mirror mode, and it will always connect to the primary processor. No other options will be available.

Configuring Mirror Mode

Configuring a device to connect in Mirror mode is done from the Displays menu in the Browser. When **[Displays]** is pressed, a **{Mirror}** softkey will be displayed. Pressing **{Mirror}** will open up a list of potential hosts in the CIA.

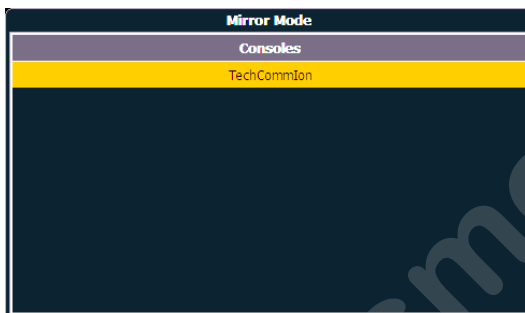

Display Prior to Being in Mirror Mode.

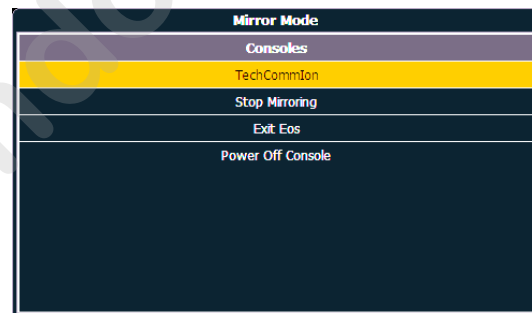

Display While in Mirror Mode

The mirror display can be navigated using the arrow keys or a mouse. When the required host is highlighted, press **[Enter]** or double click with a mouse to confirm the selection. This display can also be opened with the keyboard shortcut of ALT + M.



Note:

While in Mirror mode, the display will also have options for exiting and powering off the device.

Displays

When a device is placed in mirror mode, monitor 1 on the mirroring device matches external monitor 1 on the host, and monitor 2 matches external monitor 2 on the host. A client will mirror as many monitors as it has available.

All formats used on the host device are shown on the mirroring device including flexichannel states, column widths, chosen parameters, and pages.



Note: *Desk settings are not mirrored.*

The CIA will open on monitor 1. The CIA on the device in mirror mode can be locked open or closed. When left unlocked, the CIA will expand and close as normal. Not all CIA displays shown on the device in mirror mode. The following CIA displays are synchronized:

- About
- Effects
- Effects Status
- Color Picker
- Curves
- Undo

The CIA can be completely hidden when locked by pressing the **[Displays]** key. Pressing **[Displays]** again will display and unlock the CIA.

Exiting Mirror Mode

Exiting mirror mode can be done by selecting **{Stop Mirroring}** in the mirror display or using the keyboard shortcut ALT + X. When exiting mirror mode, the device will return to its normal, working state.



Note: *Clients without a dongle cannot exit mirror mode.*

Shutdown/Start Up in Mirror Mode

When a device is shut down in mirror mode, it will restart in mirror mode mirroring the same host as before. If the host has changed settings, mirror mode will need to be reselected on startup.

Macros

Macros can be created to configure a device for mirror mode and to exit the mode. The RPU/RVI face panel configuration utility allows the face panel buttons to be populated with these macros.



Note: *An alphanumeric keyboard will be needed to create this macro.*

To create a macro to place a device in mirror mode:

- Step 1: Set the User ID of all devices to match the Primary.
- Step 2: Press ALT + M to open the mirror mode display.
- Step 3: Highlight the device to mirror.
- Step 4: Press **[Learn] [x] [Enter]** to record the macro.

To create a macro to exit mirror mode:

- Step 5: With the console in mirror mode, press **[Learn] [x] [Enter]**
- Step 6: Press ALT + X
- Step 7: Press **[Learn]** to finish recording the macro.

Once the macros are created, you should save the show and set all User IDs back.

Appendix D

Using the RPU and RVI

This appendix outlines the setup and configuration of your Ion [Remote Processor Unit \(RPU\)](#), [Remote Video Interface 3 \(RVI3\)](#), and [Remote Video Interface \(RVI\)](#).

RPU Overview

The Ion RPU can be used as a primary, backup, or client processor in an Eos Family system. It can also be used for independent playback applications. For more information on multi-console terms such as “Primary” or “Backup”, please see [Multi-console and Synchronized Backup, page 357](#).

Ion RPU ships with the following:

- Remote Processor Unit
- USB Keyboard
- USB Mouse
- Rack Mount Hardware Kit
- IEC Power cords with varying connectors
- Label Sets

Remote Processor Unit (RPU)

Hardware Setup

Rear Panel

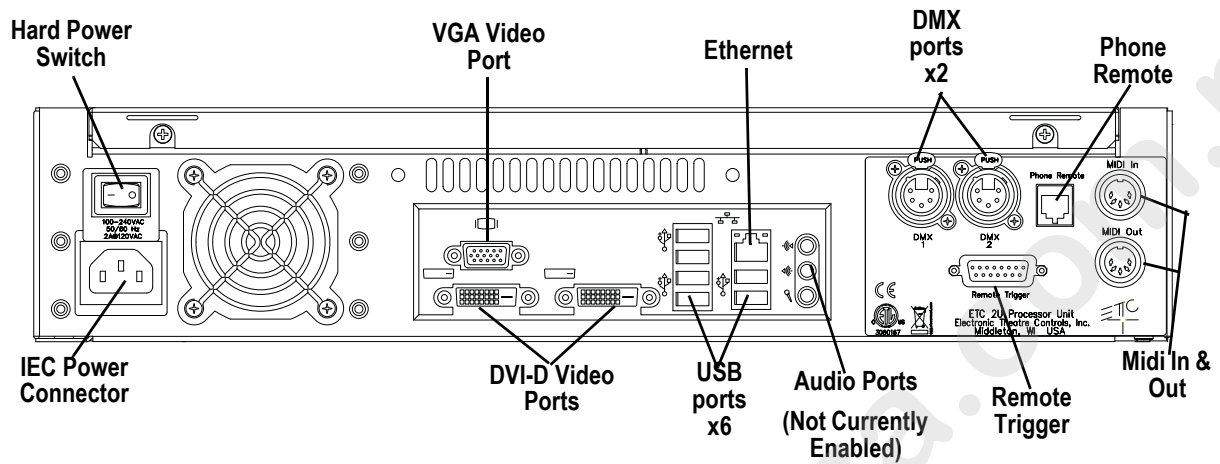

Step 1: Attach the appropriate IEC power cord to the power connector.

Step 2: Connect any monitors to the proper ports on the back of the RPU.



Note:

The Ion RPU can support up to two monitors, either two DVI monitors or one VGA and one DVI. The minimum screen resolution must be at least 1280x1024 by 32bit color.

Step 3: Connect the USB mouse and keyboard to the USB connectors.

Step 4: Attach a network ethernet cable to the ethernet port.

Step 5: Once all accessories and optional cables have been connected, switch the hard power switch on.

Front Panel

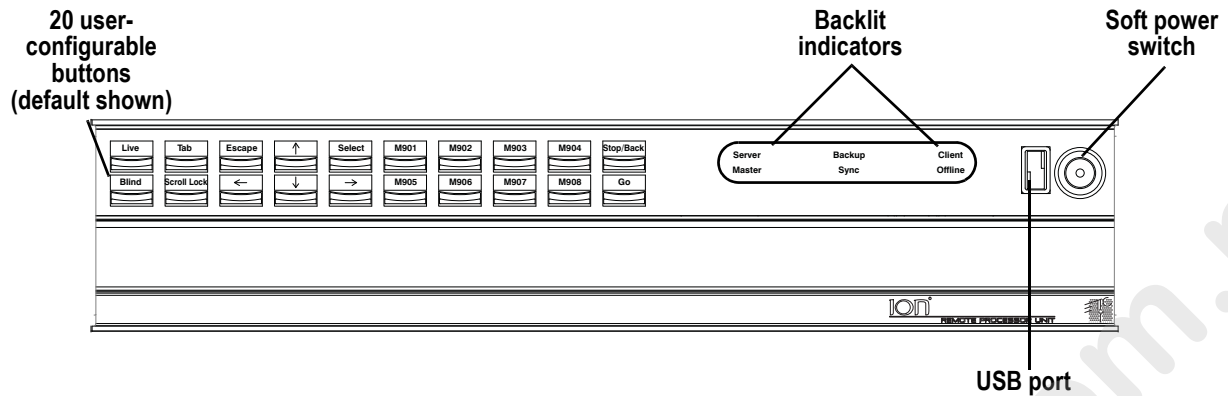

- Step 1: Press the soft power switch to activate the RPU (check rear panel to ensure power is connected and hard power switch is on).
- Step 2: The backlit indicators will identify the operating status (master, backup, client, and so on) of the unit.
- Step 3: USB port is provided for easy show loading to or from a USB storage device.
- Step 4: 20 buttons are configurable from the Eos Configuration Utility (ECU). They are set to a default configuration. The label strips for these buttons are removable and reversible. Any changes to the button configuration can be written on the opposite side in pencil.

Start Up

After connecting power to the unit, press the soft power button on the front of the console.

By default, the RPU will boot into the Ion environment as a primary. If you wish to designate your RPU as something other than a primary, you must exit the Ion environment and choose a different designation from the Eos Configuration Utility welcome screen.

For more information on multi-console terms such as primary or backup, please see [Multi-console and Synchronized Backup, page 357](#).

Software Configuration

Settings for the RPU can be altered in the Eos Configuration Utility (ECU). The 20 buttons on the front panel of the RPU are configurable from the **{RPU}** section of the ECU.



Note: *The buttons section of the ECU has two different areas, the RPU face panel buttons and the Gio face panel buttons. You will want to make sure that you are in the RPU face panel buttons area.*

To configure the RPU buttons:

- Step 1: In the Ion browser, select **File>Exit** and confirm the selection. Ion will close and you will enter the Ion welcome screen.
- Step 2: Click on the **{Settings}** button. This will open the ECU.
- Step 3: On the right side of the screen, click on **{Buttons}** to enter the RPU button setup. A virtual display of the RPU buttons is displayed with the current button settings labeled on each button.
- Step 4: Click on a button you wish to alter. A button popup window will open.
- Step 5: Click on the type of button you want it to be (Macro or Hard Key).
 - **If Macro** - Click on the Macro # box and enter the desired macro number from the keyboard and press enter. Then click **{Accept}**.
 - **If Hardkey** - Click on the **{HardKey}** drop down menu and select the hard key you wish to use. Then click **{Accept}**.
- Step 6: Repeat this process for any other buttons you wish to reconfigure.
- Step 7: To restore the default buttons at any time, click the **{Restore Defaults}** button.

To import a button configuration:

You may import an RPU button configuration file from a USB device.

- Step 1: Click the **{Import}** button in the RPU area of the buttons section of the ECU. The RPU will search for valid RPU button file.
- Step 2: If a valid file is found, the ECU will ask you if you want to import the settings. Click **{Yes}**. The settings will be imported.
- Step 3: Click **{Ok}**.

To export a button configuration:

You may export your RPU button configuration to a USB device.

- Step 1: Click the **{Export}** button in the RPU area of the buttons section of the ECU.
- Step 2: If a USB drive is available, the ECU will ask you to choose the desired drive from the drop down menu. Click on the desired USB drive.
- Step 3: Click **{Accept}**. The button configuration will be saved to the USB drive.
- Step 4: Click **{Ok}**.

For more information on settings in the ECU, please see [Eos Configuration Utility, page 333](#), and [RPU Face Panel Buttons, page 351](#).

Basic Use Guidelines

Displays

The RPU can be used with either one or two DVI monitors, or one VGA and one DVI. You can collapse or expand the CIA on the displays by engaging the scroll lock and pressing **F5**. If you are using one monitor, you may find this feature useful in increasing the efficiency of your available display area.

Net3 Services

By default, both Ion and the Ion RPU ship with all Net3 services enabled.

When used in a multi-console backup system, you must disabled Net3 services for the intended backup device. If the RPU is the intended primary (recommended, see [Backup Scenarios, page 363](#)), some Net3 services must be disabled on the intended backup device (console or RPU).

You must disable the DHCP server and TFTP server. You must also change the SNTP server to “client” to enable time synchronization between Ion devices. All of this is done using the Eos Configuration Utility (See [Network Settings, page 340](#) and [Local Area Connection, page 340](#)).

RVI3 and RVI Overview

The RVI functions as a remote user interface to access and modify the contents of an entire Ion show file. You may configure the RVI to run Ion software in “Client” or “Offline” mode.

This appendix outlines the setup and simple configuration of your Remote Video Interface (RVI) for use with an Ion Control System.

Net3 RVI 3 ships with the following:

- Remote Video Interface
- USB Keyboard
- USB Mouse
- Rack Mount Hardware Kit
- IEC Power cord
- Label Set

Remote Video Interface 3 (RVI3)

Hardware Setup

Rear Panel

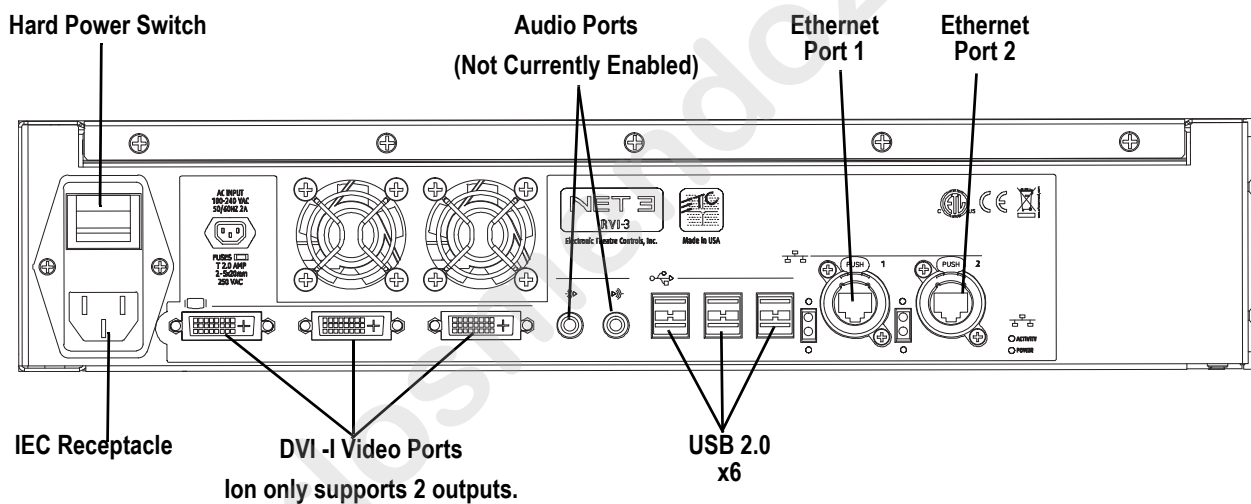

- Step 1: Attach the IEC power cord to the power connector, then to the IEC receptacle.
- Step 2: Connect any monitors to the proper ports on the back of the RVI 3.

Note:

The RVI 3 with Ion support up to two monitors. Any of the monitors can be DVI or VGA. The connectors are DVI-I. DVI-I to VGA adapters are required for VGA monitors. The adapters are not included.

The minimum screen resolution is 1280x1024.

- Step 3: Connect the mouse and keyboard to the USB connectors.
- Step 4: Attach a network ethernet cable to the Ethernet port. All communications to the associated control console are made over this Ethernet connection.
 - Connection to the console may be made either directly using a Cat5 or better null-modem cable or through an Ethernet hub or Ethernet switch using standard Cat5 or better patch cables.
- Step 5: When all connections are made, switch on the hard power switch
- Step 6: Press the soft power switch, on the front of the unit, to power up the RVI 3.



Note:

If the unit does not power up, check the hard power switch, on the rear panel, to ensure it is switched on.

Front Panel

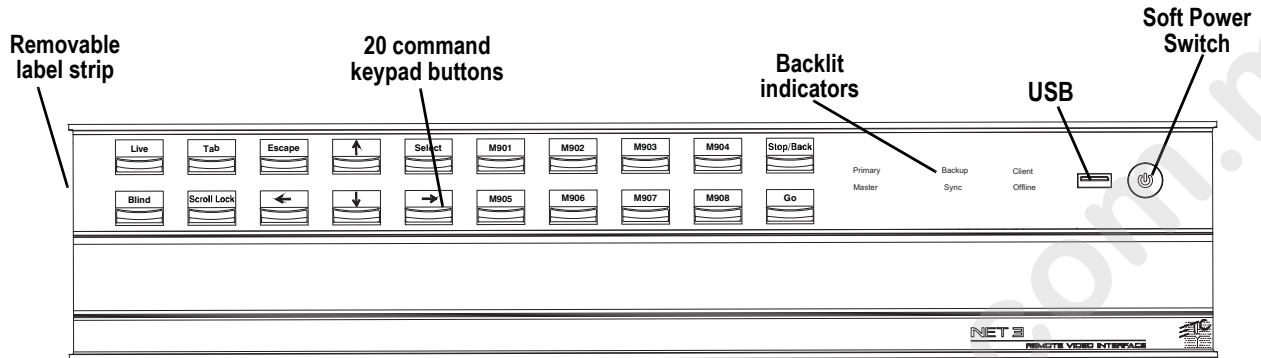

- Step 1: Press the soft power switch to activate the RVI 3 (check rear panel to ensure power is connected and hard power switch is on).
- Step 2: Backlit indicators identify the operating status (client, offline, in sync) of the unit.
- Step 3: USB port is provided for easy show loading to or from a USB storage device.
- Step 4: 20 buttons are configurable from the Eos Configuration Utility (ECU). They are set to a default configuration. The label strips for these buttons are removable and reversible. Any changes to the button configuration can be written on the opposite side in pencil.

RVI3 Start Up

At startup, the RVI will open in the Ion application or the ECU, based on the setup option. The default setting is to open in the ECU.

Remote Video Interface (RVI)



Electrical Specification

- Operating voltage 100-240 VAC, 50-60Hz (2 amps at 120 VAC).
- Ambient temperature and humidity 0 - 35° C, 95% non-condensing humidity, maximum.
- Storage temperature and humidity 0 - 35° C, 95% non-condensing humidity
- CE and ETL Compliant.
- Installation Category II, indoor use only.
- May operate up to 2000 meters altitude.

Hardware Setup



Note: Older versions of the RVI hardware will vary from the images shown here.

Rear Panel

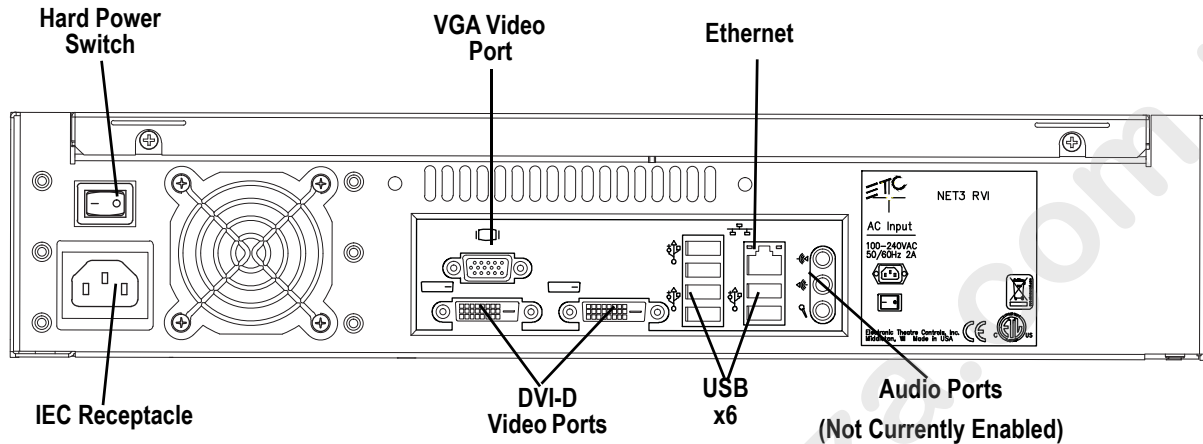

Step 1: Attach the appropriate IEC power cord to the power connector, then to the IEC receptacle.

Step 2: Connect any monitors to the proper ports on the back of the RVI.



Note: The RVI supports up to two monitors, either two DVI monitors, or one DVI and one VGA.

The minimum screen resolution must be at least 1280x1024 with 32bit color.

Step 3: Connect the USB mouse and keyboard to the USB connectors.

Step 4: Attach a network ethernet cable to the Ethernet port. All communications to the associated control console are made over this Ethernet connection.

- Connection to the console may be made either directly using a Cat5 or better null-modem cable or through an Ethernet hub or Ethernet switch using standard Cat5 or better patch cables.

Step 5: When all connections are made, switch on the hard power switch.

Step 6: Press the soft power switch, on the front of the unit, to power up the RVI.



Note: If the unit does not power up, check the hard power switch on the rear panel, to ensure it is switched on.

Front Panel

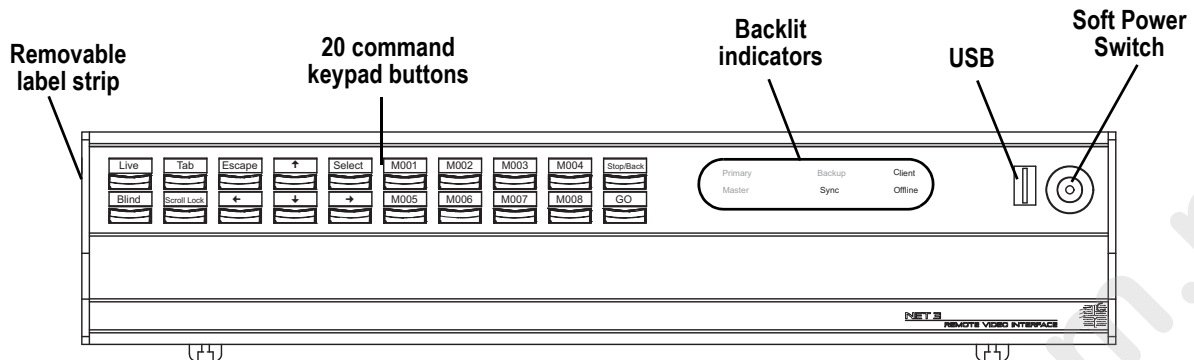

- Press the soft power switch to activate the RVI (check rear panel to ensure power is connected and hard power switch is on).
- Backlit indicators identify the operating status (master, backup, client, and so on) of the unit.
- USB port is provided for easy show loading to or from a USB storage device.
- 20 buttons are configurable from the Eos Configuration Utility (ECU). They are set to a default configuration. The label strips for these buttons are removable and reversible. Any changes to the button configuration can be written on the opposite side in pencil.

RVI Start Up

At initial startup, the RVI will display the Eos and the Congo logos. Use the mouse to select the Eos Family operating system. The RVI will initialize to the Eos environment each time the power is cycled, unless you choose to change the operating system in the related settings menu (see “Switch to Congo from Eos Operating Mode,” in the *Net3 Remote Video Interface Setup Guide*, page 3).



CAUTION: If you **{Exit}** and enter the ECU, do not select the “Primary” or “Backup” buttons that are displayed in the ECU welcome screen.
The Net3 RVI will only function as a “Client” on the Eos network or “Offline”.

Basic Use Guidelines for RVI3 and RVI

Displays

The RVI can be used with either one or two DVI monitors, or one DVI and one VGA. You can collapse/expand the CIA on the displays by engaging the scroll lock and pressing **F5**. If you are using one monitor, you may find this feature useful in increasing the efficiency of your available display area.

Button Configuration

Settings for the RVI can be altered in the Eos Configuration Utility (ECU). The 20 buttons on the front panel of the RVI are configurable from the Button section of the ECU.

Note: The buttons section of the ECU has two different areas, the RPU/RVI face panel buttons and the Gio face panel buttons. You will want to make sure that you are in the RPU face panel buttons area.

To configure the RVI buttons:

- Step 1: In the browser, select **File>Exit** and confirm the selection. Ion will close and you will enter the Ion welcome screen.
- Step 2: Click on the **{Settings}** button. This will open the ECU.
- Step 3: On the right side of the screen, click on **{Buttons}** to enter the RPU/RVI button setup. A virtual display of the RPU/RVI buttons is displayed with the current button settings labeled on each button.
- Step 4: Click on a button you wish to alter. A button popup window will open.
- Step 5: Click on the type of button you want it to be (Macro or Hard Key).
 - **If Macro** - Click on the Macro # box and enter the desired macro number from the keyboard and press enter. Then click **{Accept}**.
 - **If Hard Key** - Click on the **{HardKey}** drop down menu and select the hard key you wish to use. Then click **{Accept}**.
- Step 6: Repeat this process for any other buttons you wish to reconfigure.
- Step 7: To restore the default buttons at any time, click the **{Restore Defaults}** button.



Note: *RVI and RPU button configurations are interchangeable. Therefore you can import button configurations from one to the other.*

To import a button configuration:

You may import an RVI button configuration file from a USB device.

- Step 1: Click the **{Import}** button in the RPU/RVI area of the Buttons section of the ECU. The RVI will search for valid RVI/RPU button files.
- Step 2: If a valid file is found, the ECU will ask you if you want to import the settings. Click **{Yes}**. The settings will be imported.
- Step 3: Click **{Ok}**.

For more information, see [RPU Face Panel Buttons, page 351](#).

To export a button configuration:

You may export your RPI button configuration to a USB device.

- Step 1: Click the **{Export}** button in the RPU/RVI area of the Buttons section of the ECU.
- Step 2: If a USB drive is available, the ECU will ask you to choose the desired drive from the drop down menu. Click on the desired USB drive.
- Step 3: Click **{Accept}**. The button configuration will be saved to the USB drive.
- Step 4: Click **{Ok}**.

For more information on settings in the ECU, please see [Eos Configuration Utility, page 333](#).

Appendix E

Remote Control

Remotes Overview

Three different remotes are available for controlling Ion; the phone remote, the radio focus remote (RFR), and the iRFR/aRFR.

Phone Remote

The phone remote allows for remote control of the Ion console by using a wireless phone. The base station for the phone connects directly to the phone remote jack on the rear of your console. See [“Console Geography” on page 12](#). The numeric keypad of the phone is used to control channels and levels.

Phone Remote Functions

The numeric keypad of the phone is mapped as following:

1	2	3
+	Thru	-
4	5	6
Last	Macro	@
7	8	9
Next	Address	Full
*/Shift	0	#/Enter
Clear CL	Chan Check	Sneak

To use the commands in gray, first hit the **[*]** button followed by the number or symbol above the gray command. For example, to place a **[+]** on the command line, press **[*] [1]**.

Pressing **[*] [*]** will clear the command. Commands entered from the phone remote will appear on the command line for the console.

Phone Remote Connector

The pin outs for the phone remote RJ11 connector are:

- Pin 4 - Data +
- Pin 5 - Data -

Radio Focus Remote (RFR)

The Net3 Radio Focus Remote (RFR) provides remote access to frequently used console features such as dimmer and channel checks as well as update and record functions.

The RFR handheld remote and receiver unit features a high frequency (HF) link for bi-directional communication with a connected console. During operation, the system status can be viewed on the LCD of the remote.

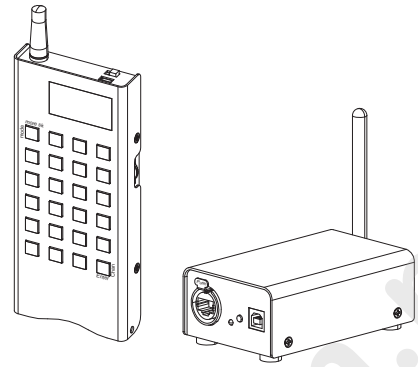

Note:

This appendix covers only RFR operation with the Eos Family control system. For information on using the RFR with Congo™ or Congo jr consoles, see the “Congo/ Congo jr User Manual” or the “Net3 Radio Focus Remote Setup Guide” for more information.

Handheld Remote

The RFR handheld unit features 24 backlit buttons and two push-button thumb wheels, one on either side for scrolling to desired targets and selecting them for interaction. The top side of the remote has an on/off power switch, a high frequency antenna and a USB Mini-B port. The USB Mini-B connection is used to supply power for the internal rechargeable NiMH AA batteries.

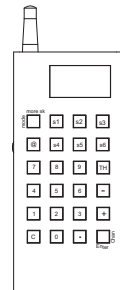

Base Station Receiver

The receiver includes a USB type B connector and an Ethernet connector (IEEE 802.3af) on the front of the unit for connection to the console (USB) or to a switch in your Net3 network

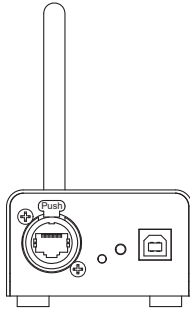

USB

When the base station is connected directly to a console by USB type B, the RFR is powered by and controls only the console the base station is connected to. ETC supplies a 1.8m (6 ft.) USB cable for base station connection to a console or USB hub. The maximum distance between products is 5m (16 ft.).

When the base station is connected to Eos/Ion using USB, the RFR remote will automatically connect to that console when powered.

Ethernet

For use with the Ion console, the base station will need to be plugged into an ethernet switch. If the switch is not power over ethernet, the base station can receive power via USB from the console.



Note:

For single base station use, no configuration is needed if defaults are used. For multiple base stations, custom configurations, and connection issues, further configuration will be needed.



CAUTION:

You may use either the ethernet connection or the USB connection for data to the console, but not both.

Console Section Mode

Holding down [.] while the remote is booting up will take you to the console selection list. This mode is used to select between Direct USB mode, Base USB mode, or available host consoles for networking.

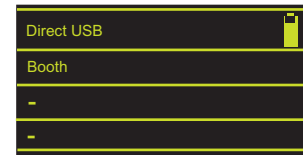

Note:

If multiple RFR units are to be used separately within a range of each other's receiver units, change the frequency and/or ID settings to avoid conflicts. Reference [Change Frequency and ID Setting](#) below for more information.

For optimal operation, set the base stations apart by at least 5m (16 ft.) to ensure the two units do not interfere with each other's operation.

Change Frequency and ID Setting

A network ID is a separate digital channel on a single high frequency (HF) setting. Changing an ID setting from the default "1" is useful when multiple systems are utilizing the same frequency.



Note: *If you change the frequency and ID settings in the handheld remote you must also change the frequency and ID settings to match in the base station.*

To change the radio settings on your remote:

- Step 1: With the remote power off, press and hold the **[C]** button. Continue pressing it and power up the unit. The display window will show the HF Channel selection screen.
- Step 2: Choose an HF Channel (1 - 12) by spinning either thumb wheel.
- While setting the HF Channel, the RFR scans each available channel for traffic which may interfere with the RFR. This feature is used to determine what frequency to use in your venue.
 - In the "Available:" field the RFR will display ***, **, * or "used". The asterisks indicate the quality of the signal at that channel. *** is best. "Used" indicates that other traffic is detected on that channel, but the RFR may still function properly.
- Step 3: Press **{Next} ([S2])**.
- Step 4: Choose a network ID by moving either thumbwheel. Allowed range is from 1 to 99.
- Step 5: Press **{Next} ([S2])**.
- Step 6: Set the HF power level. This allows you to alter the strength of the transmission signal from the remote. Allowed range is from +10 dBm to +18 dBm.
- A higher value indicates a stronger signal, but shortened battery life. A lower value indicates a weaker signal and an extended battery life.
- Step 7: Press **{Save} ([S3])**.
- Step 8: You must cycle the power to apply the new settings.



Note: *Default [S4] will reset remote settings to their default values. No confirmation is required.*



Note: *Configuration over the network must be done using the Gateway Configuration Editor (GCE).*

To change the frequency and network ID in your base station receiver using USB:

- Step 1: In the browser menu, select **File<Exit**. A dialog box opens asking you to confirm.
- Step 2: Confirm this command by pressing **{Yes}**. The Ion application will close and the Eos Configuration Utility (ECU) will display.
- Step 3: Press **{Settings}** button. A new settings dialog box will display.
- Step 4: Press the **{RFR}** button. A RFR dialog box will display.
- Step 5: Choose the appropriate High Frequency Channel setting from the drop down box (must be from 1-12, matched with the remote).
- Step 6: Choose the appropriate Network ID setting from the drop down box (must be from 1-99).
- Step 7: Accept the changes by pressing the **{Accept}** button. To cancel changes press **{Cancel}**. The next time you start the Ion application, Ion will automatically send the new settings to any base station that is connected to the console.
- Step 8: If you have any difficulty, reset the base station by disconnecting the USB cable from the console and then reconnect it. This cycles power to the unit.

Basic Use Guidelines

Keypad Function

The keypad illuminates while the keys are in use and remains illuminated while the unit is transmitting data. After a key is released, the keypad will dim the backlight until the next button press or transmission.

Most of the buttons on the handheld remote function exactly as they work on the Ion console. A select few of the buttons require additional explanation.

- **[More SK / Mode]** - When this button is pressed and released, the soft keys will change to the next page of softkeys (if there is more than one page available). Press and hold the **[More SK / Mode]** button to display the available RFR modes.
- **[Enter / Chan]** - When the RFR is connected for use with an Ion console, this button functions as **[Enter]**, which terminates the command line.
- **[@]** - The first press of this button is “at”. The second consecutive press is “at level”. The third press is “at Out”.
- **[S1 - S6]** - These six buttons are softkeys, defined by the operating mode and identified in the bottom portion of the LCD (see below).
- **[.]** - The first press of this button is “.”. The second consecutive press is “/”.

LCD General Layout

Details of current target 		
Command Line		
S1	S2	S3
S4	S5	S6

The handheld remote LCD is divided into four sections. The top section displays status for the selected target. The middle section displays the command line. This section scrolls to accommodate viewing long command syntax. The next section displays the console’s mode status and error status (if any). The bottom section displays the current function of the soft keys (it also displays the various modes when **[Mode/More SK]** is pressed and held).

Thumbwheels

The two thumbwheels on the RFR (one left, one right) have varying functionality depending on the selected mode (see [RFR Operation Modes, page 383](#)). Generally speaking, the left thumbwheel acts as a level wheel. It increases or decreases intensity for selected channels. The right thumbwheel behaves as next and last for scrolling through data lists.

Recharge the Handheld Battery

A battery level indicator is found in the upper right corner of the handheld LCD. When the battery is near to a complete drain, the indicator will flash. When charging, the indicator will depict increasing power to verify that it is charging.

When the remote is not in use, set the switch to the “Off” position to guard against accidental key presses and to conserve battery power.

Charge the battery using the USB Mini-B cable that shipped with your RFR. Connect the USB Mini-B connector to the handheld remote and the other end to the USB charger adapter supplied with your RFR. You may also attach the USB cable to a powered USB-hub, personal computer, or your console. A full recharge may take up to 12 hours.

Provided there is enough battery charge, you may use the remote while charging.



CAUTION: *If you choose to charge the remote from the Ion console, you should unplug the base station before doing so.*

The remote will be functional once it is connected directly to the console. If the base station is still connected and a command is entered on the remote, multiple iterations of the command may register and this may create errors in the Ion command line.

Remotes Enabled/Disable

Remotes must be enabled before using. For more information, see [{RFR Settings}, page 109](#) and [RFR, page 352](#).

Remotes Enabled/Disable Via a Macro

A macro can be used to enable or disable all remote control (RFR, WFR, iRFR, aRFR) connections. The macro can either be a toggle between enable or disable, or it can have an absolute action of either enabling or disabling remote connections using the **{Enable}** and **{Disable}** softkeys un the Macro Editor. See [“Macro Editor Display” on page 290](#).

RFR Operation Modes

The Ion RFR defaults to opening in Channel Check mode the first time. The next time it is connected, the RFR will return to the last mode it was in. There are other modes available in the RFR, however. To switch modes, hold down the **[Mode/More SK]** button and then select the desired mode from those available by pressing the appropriate softkey. Mode options are: Channel Check, Park, Live, Playback, and Patch.

Channel Check Mode

This mode allows you to perform channel and address checks. The default is Channel. Check will automatically be placed at the end of every command while in this mode.

Softkeys

The following softkeys are available for Channel Check mode:

- Address
- Last
- Full
- Next

The right thumbwheel acts as next/last buttons. The left thumbwheel doesn't have a function in this mode.

Park Mode

This mode is used for parking channels and also for "channel check" and "address check" functions.

Softkeys

The following softkeys are available in park mode:

- Address
- Channel
- Last
- Full
- Out
- Next

{Address} and **{Channel}** are used to select addresses or channels for parking.

- **<Channel> [7] [@] [5] [Enter]** - Parks channel 7 at 50%.
- **{Address} [8] {Full}** - Parks address 8 at full.

{Full} and **{Out}** are used to set those levels for channels or addresses. **{Out}** parks the channel or address at 0.

- **[9] [@] [Enter]** - un parks channel 8.

Live Mode

Live mode is used for modifying levels and recording or updating cues. This mode is intended to allow you to make basic adjustments to show data. Buttons and softkeys function as they do within Eos/lon.

The command line is displayed in the LCD to verify the commands you enter. It also displays details for the currently selected channel or the current cue (if no channels are selected).

Softkeys

The following softkeys are available on page one of live mode:

- Group
- Rem Dim
- Sneak
- Full
- Out
- Macro

The following softkeys are available on page two of live mode:

- Rec
- Update
- Time
- Cue Only/Track (shown as “Qoly/Tk”)
- Address

{Macro} allows you to execute a macro.

- **{Macro} [3] [Enter]**

In live mode, the left thumbwheel controls the level of the selected channels. The right thumbwheel acts as next and last buttons, defaulting to next or last cue selection for the currently selected cue list.

Playback Mode

Softkeys

The following softkeys are available in playback mode:

- Sub
- Load Q
- Stop/Bk
- Out
- Goto Q
- Go

{Sub} is used to set the level of a submaster.

- **{Sub} [5] [@] [7] [Enter]** - sets submaster 5 to 70%.

{Load Q} allows you to load a cue into the pending file *for the master playback fader pair only*.

- **{Load Q} [5] [Enter]** - Loads cue 5 of the master playback fader to the pending file for that fader. Pressing **{Go}** will execute this cue.

{Go} and **{Stop/Bk}** are duplicates of the **[Go]** and **[Stop/Back]** buttons for the Eos/Ion master fader pair.

{Goto Q} allows you to jump to any cue in the show.

- **{Goto Q} [6] [Enter]** - plays back cue 6 for the master playback fader pair.
- **{Goto Q} [4] [.] [.] [2] [Enter]** - plays back cue 2 from cue list 4. To play back cues from any other list than the one loaded to the master playback fader pair *requires* you to specify the cue list in the command line.

The left thumbwheel controls intensity of a selected submaster. The right thumbwheel acts as next or last for the most recently selected cue list.

Patch Mode

In patch mode, the LCD displays the channel, address and type for the currently selected channel(s).

Softkeys

The following softkeys are available in patch mode:

- Address
- A
- B
- /
- Fixture Controls (shown as: FixCtrl)

{Address} allows you to change the address of the selected channel.

- **[1] {Address} [1] [Enter]** - addresses channel 1 to output 1.

{A} and **{B}** are used for patching dimmer doublers.

- **[9] [7] [Th] [1] [0] [2] {Address} [1] {B} [Enter]** - patches channels 97-102 to outputs 1B-6B (for dimmer doubling).

{/} is used to patch the port and offset.

- **[2] {Address} [3] [/] [1] [Enter]** - patches channel 2 to port 3 offset 1 or address 1025.

{FixCtrl} is used to display the fixture controls for a channel (if available).

- **[6] {FixCtrl}** - displays fixture controls for channel 2.

The thumbwheel will scroll through the available fixture controls. Press the thumbwheel to activate the fixture control.

Technical Specifications

Handheld Transmitter

Output U.S.A. - Default HF:1 (2.410 MHz) with 11 additional HF: channels available (2.410 - 2.465 GHz). 99 groups available per channel.

Antenna - Helical, fixed.

Connections - Integral USB Mini-B connector for charging the unit.

Working range - 90m (300 ft) indoor, 200m (656 ft) in free field.

Power - 2x NiMH rechargeable battery. (Recharge using the USB connection.)

Size - 160mm(4.5") x 72mm (2.6") x 20mm (.8") excludes antenna.

Weight - 400g (14 oz.) includes antenna.

Base Station Receiver

Data - USB type B. Ethernet.

Connections - Integral USB connector to console or RPU. Ethernet 802.3af.

Power - USB or Power over Ethernet (PoE).

Maximum USB cable length - 5m (16.5') from power source using USB.

Size - 112mm(4.4") x 71mm (2.7") x 45mm (.7") excludes antenna.

Weight - 380g (13 oz.) includes antenna.

iRFR

The iRFR is a software application that runs on an Apple iPhone® or iPod Touch. The application can be downloaded from the Apple Application Store, search for iRFR. The iRFR offers the same functionality of the RFR. A closed wireless network is needed.

For additional information on the iRFR, including setup, please visit the www.etconnect.com/wiki.

aRFR

The aRFR is an application that runs on Android devices. The application can be downloaded from the Android Marketplace, search for aRFR. The aRFR offers the same functionality of the RFR. A closed wireless network is needed.

For additional information on the aRFR, including setup, please visit the www.etconnect.com/wiki

Appendix F

Universal Fader Wings

Overview

Universal fader wings can be used in conjunction with your Ion console to facilitate the use of submasters and playbacks. The wings are available in 2x10 or 2x20 or 1x20 configurations.

The fader wings are designed to physically attach to your Ion console, thereby receiving power from the console and eliminating the need for the external power supply. Or you may connect wings to Ion using a USB cable and provide power using an external power supply.

1 x 20 Setup

The 1 x 20 fader wing is specifically designed to be physically attached to your console. A USB cable connection is required.

To install the 1 x 20 on your Ion console, follow the instructions that were included with the 1 x 20 wing. Be sure to connect the wing to Ion using the USB cable that was included with the wing.

2 x 10 and 2 x 20 Setup

2x10 and 2x20 Universal Fader Wings may be attached together and then physically attached to Ion consoles.

Wings may also be connected to an Ion console, RPUs, or RVIs using a USB cable. When connecting fader wings with a USB cable, one external power supply must also be used.

Rules of Connection

Rule One

Your entire system is limited to a total of 300 faders per processor (Ion, RPU, RVI).

Rule Two

No more than three fader wings may be physically attached to each other. This means:

- A maximum of three fader wings may be directly attached to either side of a console (3 per side).
- A maximum of three fader wings may be connected using a USB cable to form an external array using an external power supply.



Note:

Only one wing (2 x 10 or 2 x 20) may be used with Eos Family offline software running on a personal computer. The Mac OS is not supported.

Connecting Wings to Ion

Up to three Universal Fader Wings may be attached together and then connected to Ion using a USB cable only or by physically attaching them to the Ion console. Both sides of Ion may have up to three wings attached.

The best way to attach wings together is to attach them in order from left to right.

Attach Universal Fader Wings

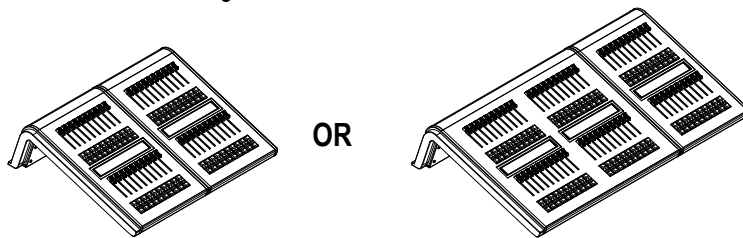

Step 1: Using a #1 Phillips head screwdriver, on the underside of the wing(s) remove the two screws securing the bumpers that will be removed from the appropriate side or sides of the wings. The bumpers will be removed in a later step.

- a: Carefully turn the wing over and place it faders-down on a clear, flat work surface.



CAUTION:

Do not set the wing on the connector side (rear panel). Instead, place it face down on the faders.

- b: Remove and save the two screws securing the bumper to the side of the wing.

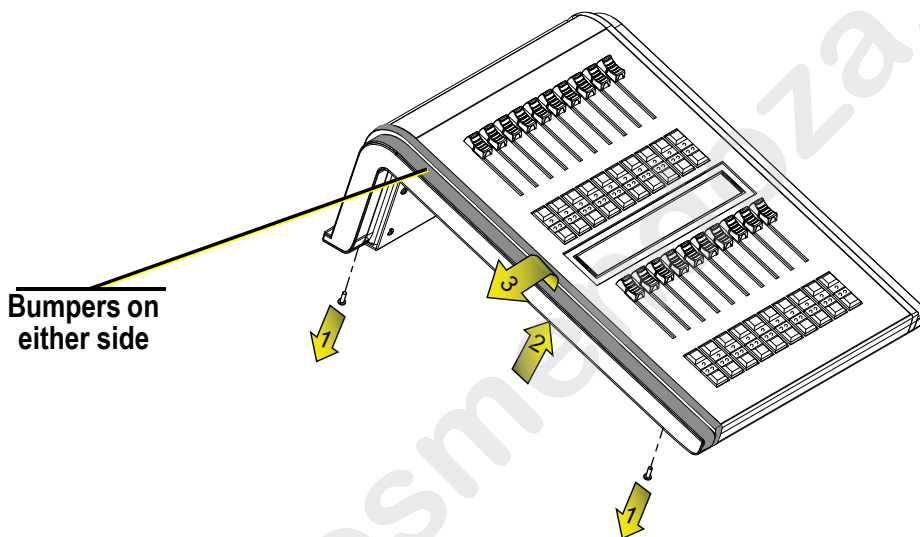

Step 2: Turn the wing over to return it to its upright position.

Step 3: Remove the bumper(s) from the wing.

- a: **Right Side** - Gently pull the bumper up until it is flush with the facepanel.
Left Side - Gently push the bumper down until it loosens from the facepanel.
- b: Pull the bumper away from the facepanel until it is free from the wing.

Step 4: Repeat steps 2 and 3 for each side of each wing that needs to be exposed.

Step 5: Align the two wings. Lift the wing on the right and place it gently on the hooks provided on the wing on the left. Check that the two wings are aligned properly front and back,

then press down gently on the right wing until it is fully seated. This should be a smooth connection but may require a little force.

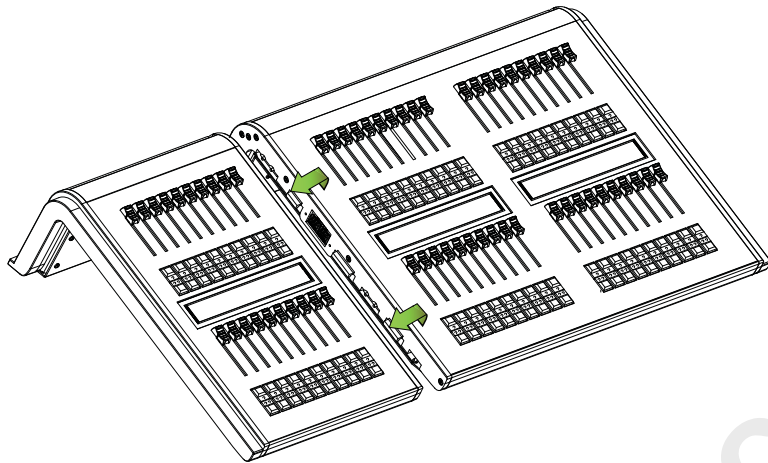

- Step 6: Repeat above procedure to connect another wing to the right end of the pair, if desired.
- Step 7: Re-insert screws to secure wings together and secure the bumpers to the sides of the wings.

Attach fader wing array to Ion

Once all of the desired wings are attached (within the limits above), you may use the same procedure above to attach the wings to Ion.

Connect Universal Fader Wing(s) to Console with USB Cable

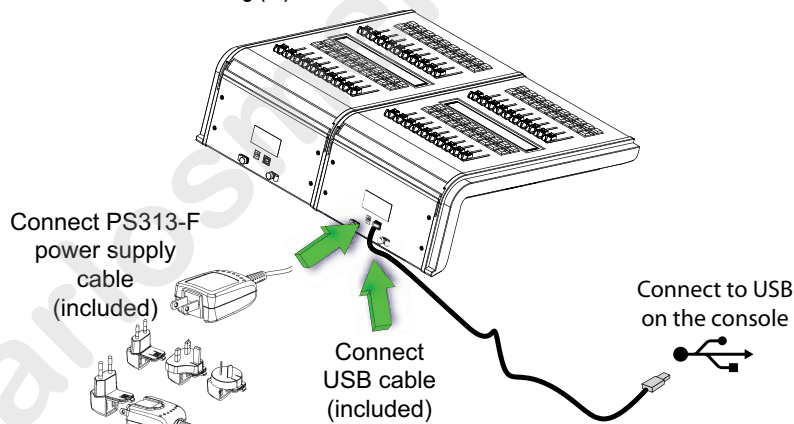

- Step 1: With the console power off, connect the USB A to B cable (provided) between the console and one wing as shown above. If multiple wings are joined, only one power and one USB connection is required for all joined wings.
- Step 2: Using the power supply adaptor kit, connect the fader wing to a power source.
- Step 3: It is recommended that you run the power and USB cables through the strain relief included on the back of the wings.
- Step 4: Turn the console on.

User Guidelines for Fader Wings

Fader Wing Interaction With Ion

1x20

When connected with a USB cable, the 1 x 20 will automatically be populated with the faders 1-20. Any other fader wings will then be populated with successive fader pages.

2x10 or 2x20

Ion will automatically recognize the fader wings and their configuration (2 x 10 or 2 x 20) once they are connected to the console. The system will configure the faders according to the configuration in fader wing configuration screen, for more information see [{Fader Wing Config}, page 108](#). The left most fader will be fader 1 on page 1, next will be fader 2 on page 1, and so on.

Multiple wings connected

If multiple wings are used in conjunction with each other, configuration will automatically adhere to the following logic.

1x20

Anytime a 1x20 is attached to Ion, it will automatically load the first 20 faders. Other wings will then be populated, starting with the 21st fader.

2x10 and 2x20

When 2x fader wings are attached to each other, the faders will populate continuously across the attached array according to the configuration in fader wing configuration screen. The top row of all wings will be successive from one wing to the next. The bottom row will start where the entire top row left off and then will also be successive from one wing to the next.

Therefore, when fader wings are attached to each other:

Top Row Faders	1 - 10	11 thru 30	31 - 40
Bottom Row Faders	41 - 50	51 thru 70	71 - 80
	2x10	2x20	2x10

LCD

The display at the center of the fader wing shows information about the faders.

For submasters the sub number, label, and current value (0-100%) of the fader are shown. When the page is changed, the current value will display the necessary percentage the fader must be set at to match the required level of the submaster.

For playbacks the cue list number will be shown preceded by an "L" {for example "L3" = cue list 3}. Beneath this the current pending cue is displayed in an oval shape.

For Grandmasters, a "GM" is displayed and the current output percentage is shown (100% - blackout).

Using the Buttons

Each fader is equipped with two buttons beneath the potentiometer. When used with submasters, the bottom button is the bump key. The top button can be used in two ways. When pressed in conjunction with the bump button it will act as a “Load” button for that fader and can be used to load submasters. When pressed individually, it will act as a group select button for all channels in that submaster. Pressing it in this instance is the same as entering **[Group] [Sub] [x]** on the command line.

For playbacks, the bottom button acts as a **[Go]** button and the top button acts as a **[Stop/Back]** button, similar to the buttons beneath the master fader pair on Ion.

When pressed together, these buttons act as a **[Load]** button for that fader which can be used to load faders or to use any of the fader controls such as **{Release}** or **{Stop Effect}**.

Loading Faders

To load a submaster or playback onto an unmapped fader, specify the desired submaster or cue list on the command line and press **[Enter]**. Then press both fader buttons (which equals **[Load]**).

To load contents to a fader that is already mapped, you may have to release the fader by pressing and holding **[Fader Controls]**, pressing **{Release}**, and then pressing both fader buttons (**[Load]**).

To assign a fader as a Grandmaster, you must do so in the fader configurator in setup.

Holding down the **[Fader Control]** button while a fader wing is attached will cause the last button on the wing to toggle between Channel and Fader modes.

Fader Wing Paging

The fader wing is paged using the **[Fader Controls]** button on the Ion console. Fader pages are delineated in 10 fader increments. If you advance to the next fader page, your entire fader wing array will advance by a total of 10 faders.



Note: *On a 2x10 fader wing, you can only access the first 19 pages of faders.*

To change the fader page of a fader wing:

- Step 1: Press and hold the **[Fader Controls]** button on the Ion console. The LCD on the fader wing will display the available pages beneath the fader bump buttons.
- Step 2: Press the bump button corresponding to the page you wish to display on the fader wing. The fader wing will display those faders after your selection is made.

Using the Faders

When the page is changed, the fader wing LCD will display information for any mapped submaster or loaded playback. Unmapped faders will display no information.

Submaster LEDs will illuminate in the color of the new submaster loaded on the page (green for additive and red for inhibitive). Fader wing submasters are not motorized, therefore when you change pages you may have to manually reset the fader to the proper location to reflect its current output level. If a submaster setting must be matched to gain control, the LED will flash quickly in the appropriate color. The LED will stop flashing and illuminate normally once the fader has been moved to the required location.

When loaded with a playback, you may use the fader to interrupt a fade in progress and switch the fade to manual timing. First press **[Go]** and while the fade is in progress, drop the fader to zero and then raise the fader at the desired rate. Once it is raised fully, the fade will complete and control will be returned to the buttons.

Index

Symbols

-%	126
+%	126

A

about	
about	268
channel	270, 272
cue	275
curves	276
effects	276
groups	275
palettes	275
presets	275
system	269
absolute data	
with palettes	147
absolute effects	248
absolute palette	
<i>description</i>	140
accessories	
patching	75
active cue list	
changing	206
<i>Address</i>	
in live	131
address	
parking in live	237
allfade	177, 206
aRFR	343, 388
assert	
and load	224
at channel level	205
at cue level	205
cue list	224
flags	177
using with cue lists	204
assign	
virtual faders	220
At //	116
At Enter	179
AutoMark	192
allowing live moves	192
timing	192

B

back (key)	221
background (softkey)	
in cue list index	210
backup	357–363
backup console	357
client	357
master	357
offline console	357
primary	357
backup console	
<i>definition</i>	357
basic manual control	111
beam palette	
<i>description</i>	140
blackout	221
blind	
channel display	147
display indicators	31
editing cues in	186
editing palettes in	147
editing presets in	157
recording cues in	186
spreadsheet view	41
edit palettes in	148
storing multipart cues in	214
text indicators	33
using encoders in	188
block	176
channels/parameters	176
cues	176
browser	22
clear	27
file	
save as	57
<i>Image</i>	24
navigating within	24
virtual keyboard	24
bump button	
timing	265
buttons	
configuration	351
by type palette	
<i>description</i>	140
by type palettes	150

C

calibrate scroller	72	color palette	
capture	233	<i>description</i>	140
Central Information Area (CIA)	22	color picker	
browser	22	<i>description</i>	121
favorite display	23	command history	234
locking	23	command line	
parameter display	22	about	22
parameter display in	115	syntax structure	4
unlocking	23	configuration utility	333–348
virtual keyboard	24	configure	
channel		gateways	14
delete	66	grandmaster	98
faders	112	Ion DMX ports	351
swapping	66	nodes	14
unpatching	66	show control ports	352
channel check	131	console	
channels		capacities	15
asserting	205	cleaning	14
display conventions	31	geography	12
homing	123	playback controls	216
moving	65	conventional fixtures	
multiple intensity	124	display conventions	31
ordered with groups	134	copy	
selecting	112	fixture	92
using about	270, 272	copy to	228
CIA. <i>See Central Information Area</i>		create	
cleaning Ion	14	cue	165
clear		cue list	204
cue attributes	175	curve	279
filters	201	fixture in patch	88
patch	87	group	134
submaster	264	macro	
clear functions	27	using editor display	292
clear patch	27	new fixture	88
clear show	27	palette	142
reset patch	27	preset	152
reset system	27	submaster	258
client console		cue	
<i>definition</i>	357	recording an effect	253
close		selected, the	217
displays	28	in blind	217
color control		in live	217
from encoders	120	cue level timing	
color effects	251	setting	169
color indicators		cue list	
in live/blind	32	out of sequence sync	178
		cue list index	208
		{Background}	210

{edit}	210	from summary view	187
{HTP/LTP}	209	from table view	187
{independent}	209	using {At} {Enter}	179
{Solo Mode}	210	using {move to}	
opening	208	in blind	188
cue lists		in live	180
{assert} & {load}	224	using {Record Only}	180
active list, changing the	206	using {Record}	179
attributes	209	using {Replace With}	188
manual master	226	using {Update}	181
new, recording to		modifying in live	179
using {Record Only}	204	multipart	
using {Record}	204	about	211
recording to new	204	changing to	214
using assert	204	changing to a standard cue	214
Cue Only mode		deleting a part	214
deleting cues in	189	setting part attributes	213
cue playback	215	numbering	164
cue settings		out of sequence	218
in setup	99	using go to cue	218
cues		part. See <i>cues - multipart</i>	
{At} {Enter}	179	recording	
about	164	using {Record Only}	166
applying curves to	281	using {Record}	165
asserting	205	recording in blind	186
attributes	173	recording in live	165
clearing	175	recording multiparts in live	212
follow/hang	173	settings	
label	175	in setup	99
link/loop	174	storing	
rate	175	selective	167
basic programming	164	using {Cue Only/Track}	
block	176	in Cue Only mode	168
cue list index	208	in Track mode	168
opening	208	storing multiparts in blind	214
deleting	189	timing	169
in Cue Only mode	189	delay	173
in Track mode	189	discrete	172
editing in blind	186	manual	170
external links	178	parameter category	170
flags	176	setting	169
allfade	177	updating	
assert	177	to references	182
block	176	without references	182
mark	177	updating multiparts in live	213
preheat	177	using {About}	275
go to cue	218	using {Allfade}	206
manual control during playback	222	curve	
modifying		delete	281
from spreadsheet view	187	in patch	78
		curves	
		about	278

applying	
to channels in patch	281
to cues	281
creating	279
editing	280
scroller fan	71
using about	276
custom fixture	92

D

data (navigation key)	35
database settings, in patch	80
delay	
effects	255
delay timing	173
delete	
channel	66
cues	189
curves	281
groups	135
macros	294
palettes	149
parts from multipart cues	214
presets	158
show file	58
snapshots	285
submasters	264
delete a channel	66
desk lamps	14
dimming	14
desk setup	103
dimmer	
<i>See address.</i>	
dimmer check	
<i>See {Address}</i>	
dimmer doubling	
in patch	65
direct selects	
flexi mode	26
opening	25
organizing	26
selecting channels with	25
discrete timing	172
display	
indicators	
mark	194
display indicators	31

displays	
attribute, in patch	78
blind channel	147
changing format	39
close	28
color indicators	32
controlling	28
conventions	31
database, in patch	80
effect status	244
expanding	30, 31
macro editor	290
moving	29
navigating	28
open	28
from the browser	28
from the hardkeys	28
from the softkeys	28
parameter	22
park	
parking from	238
patch	
opening	61
settings	76
playback status	
color indicators	37
<i>Image</i>	42
indicators in	37
text indicators	37
scrolling within	29
selecting	29
spreadsheet view	41
summary data view	39
table view	40
zooming	30

DMX

outputting	14
from Ion	351

E

edit (softkey)	
in cue list index	210
editing	
cues in blind	186
curves	280
effect	
live	253
from submaster list	266
groups	

from group list index	136	description	117
groups in live	135	form control	119
macros	293	<i>Image of</i>	117
palettes in blind	147	locking	45
palettes in live	146	navigating	45
palettes in spreadsheet view	148	setting non-intensity parameters	116
parameters in new fixture	88	shutter control	120
presets	155	using in blind	188
in spreadsheet view	158	enter (key)	
in table view	157	using in syntax	5
presets in blind	157	ETC locations	3
ranges for new fixture	91	ETC Technical Services	3
scroller in patch	71	expanded timeline format	42
snapshots	285	expanding displays	30, 31
wheel in patch	71	export	
effect		.csv	58
delaying	255	ASCII	58
effects		Fast Focus Pro	58
about	240	show file	58
absolute	248	external links	178
programming	249	F	
applying an existing	253	facepanel	
color	251	locking	23
cue	253	Facepanel Shortcuts	353
editing		fader	
live	253	manual master	226
focus	250	fader control (hardkey)	221
linear	251	fader pages	220
multiple intensity HTP	250	faders	
relative	250	assigning	220
color	251	auto playback enabled	220
defining a pattern	252	manually	220
focus	250	changing pages	220
linear	251	channel	112
programming	252	configuration in setup	98
status display	244	fader control (hardkey)	221
step	245	intensity master	210
programming	246	manual master	210
stopping	253	playback	215
submasters	254	playback controls	221–225
using {Stop Effect}	225	go	221
using about	276	stop/back	221
encoders		proportional	210
about	45	rate override	225
blind	45	release	225
color control	120	slider module	25
flexi	45	virtual	220
image control	120		
LCD			

assigning	220
virtual <i>See Slider module</i>	25
fan	160
file	
create new show	50
filters	
about	199
partial filters	201
record filters	200
storing data with	201
removing	201
using with palettes	144
fixture creator	88
opening	88
update library	92
fixture library	
updating in show file	92
flags	176
allfade	177
block	176
channels/parameters	176
cues	176
mark	177
flash	132
flash off	132
flash on	132
flexichannel	
<i>description</i>	36
partitioned	332
patch views	62
flip	131
focus effects	250
focus palette	
<i>description</i>	140
follow/hang	173
form control	119
group list index	
using	136
format	
changing	39
summary data view	39
freeze	224
G	
gateways	14
go (key)	221
in playback	221

go to cue	218
timing	218
with multiple cue lists	207
go to cue 0	
& {Load}	221
command line	207
playback button	221
go to cue out	207
grandmaster	
configuring	98
Graphical User Interface (GUI)	
display conventions	31
group list index	136
editing from	136
opening	136
groups	
about	133
deleting	135
editing	
from the group list index	136
editing in live	135
group list index	
opening	136
numeric view	136
ordered channels	134
ordered view	136
recalling	135
recording in live	134
recording with offset	135
selecting	135
updating in live	135
using about	275
GUI. <i>See Graphical User Interface</i>	

H

hang	173
help system	
<i>description</i>	8
high <i>See highlight</i>	
highlight	128
rem dim	129
home (hardkey)	123
HTP	7
in cue list index	209

I

image control	
---------------	--

from encoders	120	opening	156
import		submaster	
ASCII	57	editing from	266
custom fixture	92	opening	266
Lightwright	57	Littlites	14
show file	57	dimming	14
in	136	live	
independent		{Address}	131
in cue list index	209	display indicators	31
indicators		editing effects in	253
in playback status display	37	editing groups in	135
indicators in live/blind	31	editing palettes in	146
intensity		editing presets in	155
manual override in playback	223	modifying cues in	179
set with level wheel	114	park	236
setting	114	parking addresses in	237
-%	126	recording cues in	165
+%	126	recording multipart cues in	212
intensity master	210	storing macros in	288
intensity palettes		storing presets in	152
<i>description</i>	140	text indicators	33
Ion User Forums	8	updating groups in	135
iRFR	343, 388	updating multipart cues in	213
K		load	
keypad		partial show	51
selecting channels with	112	submaster	263
setting parameters with	116	lock icon	23
keywords		locked palette	
adding in patch	80	<i>description</i>	141
L		locking	
label		facepanel	23
cue	175	loop	174
lamp controls	125	low <i>See lowlight</i>	
last (key)	113	lowlight	128
learn (key)	288	LTP	7
LEDs		in cue list index	209
patching	75	M	
level wheel		macro editor display	290
setting intensity with	114	macros	
linear effects	251	about	287
link/loop	174	create new	
list view		using editor display	292
group	136	deleting	294
palettes	148	editing	293
presets	156	editor display	290
		modes	291

playing	294	highlight	128
stopping	294	home (hardkey)	123
storing in live	288	lowlight	128
using {Learn}	288	make manual	231
magic sheets		make null	230
about	296	offset	113
array	302	remainder dim	127
backgrounds	305	selecting channels	112
creating	300	setting intensity	114
display	297	setting lamp controls	125
display tools	298	settings <i>see setup</i> .	
editing	300	sneak	130
editing objects	308	submasters	265
examples of	309	timing	
fixture symbols	305	manual, for cues	170
importing fixture symbols	305	manual master	226
importing icons	305	manual override (key)	223
importing images	305	in playback	223
keyboard shortcuts	299	mark	
layout tools	301	about	191
list	298	allowing live moves	192
multi-touch gestures	299	AutoMark	192
navigating	299	AutoMark timing	192
object library	303	display indicators	194
object properties	307	flag	177
objects	303	referenced marks	193
quick save	300	removing referenced marks	194
targets	307	setting referenced mark flags	193
make manual		timing, referenced marks	197
about	231	mark time	97, 197
with multiple cue lists	204	master console	
make null		<i>definition</i>	357
about	230	merge	
managing show files	49	.esf	54
manual control		show file	54
{last}	113	MIDI	
{next}	113	ports	
advanced	227	configuring	352
capture	233	setup	100
copy to	228	mirror mode	365
recall from	229	ML Controls	46
channel check	131	virtual control	46
controlling non-intensity parameters (NPs)	115	move to	
during playback	222	in patch	65
encoder LCD	117	move to (softkey)	
flash	132	about	132
flip	131	with cues in blind	188
		with cues in live	180

moving displays	29
Moving Light Control	46
moving lights	
display conventions	31
patching	75
multiconsole	357–360
features of	360
multipart cues	211
about	211
attributes	
setting	213
changing into standard cues	214
changing standard cues into	214
recording in live	212
storing in blind	214
updating in live	213
multiple intensity channels	124
multiple intensity HTP effects	250
multiple users	311, 327

N

navigating	
encoders	45
navigation keys	
{data}	35
{time}	35
next (key)	113
nodes	14
non-intensity parameters (NPs)	
controlling	115
setting	
-	116
-%	126
+	116
+%	126
setting with encoders	116
NPs. <i>See non-intensity parameters</i>	
numbering	
cues	164
numeric view	
groups	136

O

offline console	
<i>definition</i>	357
offset	113
channels in groups	135

in patch	67
online forums	
register for	8
OOS Sync	178
open	
direct selects	25
displays	28
from the browser	28
from the hardkeys	28
from the softkeys	28
fixture creator	88
partial show	51
slider module	25
ordered channels	134
ordered view	
groups	136
out	
go to cue	207
out of sequence cues	218
using go to cue	218
out of sequence sync	178
output DMX	14
from Ion	351

P

paging	
encoders	45
faders	220
softkeys	47
palettes	
about	139
absolute	140
as absolute data	147
beam	140
by type	140, 150
color	140
deleting	149
editing in blind	147
spreadsheet view	148
editing in live	146
filters	144
focus	140
intensity	140
list view	148
locked	141
options	140
recalling	145
rerecording	146

selective storing		editing	
using {Record}	143	scrollers	68
storing	142	wheels	68
using {Record only}	143	editor	69
using {Record}	142	fixture creator	88
types of	140	LEDs	75
updating	146	move to	65
using about	275	moving channels	65
parameter category timing		moving light	75
setting	170	offset, using	67
parameter display		picker	68
about	115	preheat	78
parameters		reset	87
display	22	scroller picker	68
display in CIA	115	settings	76
homing	123	swapping channels	66
setting		unpatch a channel	66
keypad, using	116	wheel picker	68
snap	93	phone remote	377
park		playback	
about	236	fader controls	
addresses in live	237	assert	224
display		freeze	224
parking from	238	Go	221
in live	236	manual override	223
scaled	237	rate override	225
part. <i>See multipart cues</i>		release	225
partial filters	201	stop effect	225
partial show loading	51	Stop/Back	221
partitioned control	329	timing disable	224
about	330	intensity	
create partitions	331	manual override	223
partition list	330	manual control during	222
selecting partitions	330	out of sequence cues	218
setup	330	using {Go}	221
using partitions	332	using {stop/back}	221
patch	59	using go to cue	218
accessories	75	playback faders	
adding keywords	80	about	215
applying curves in	281	playback status display	43
assigning curves in	78	color indicators	37
attribute display	78	expanded timeline format	42
clear	87	<i>Image</i>	42
database display	80	indicators	37
deleting a channel	66	text indicators	37
dimmer doubling	65	playing macros	294
display	61	power	
<i>Image</i>	76	powering down	19
		powering up	19

preheat	
cue flag	177
in patch	78
presets	
about	151
absolute	153
deleting	158
editing in blind	157
spreadsheet view	158
table view	157
editing in live	155
list view	156
opening	156
locked	153
options	153
recalling	154
removing channels from	149, 158
rerecording	155
storing	
using {Record Only}	153
using {Record}	152
storing in live	152
updating	155
using about	275
primary console	
<i>definition</i>	357
print	
show file	55
proportional fader	210
protocols	342
ACN	342
ArtNet	342
Avab UDP	342
Q	
query	
adding keywords to channels	80
quick save	
magic sheets	300
R	
Radio Focus Remote (RFR)	377
basic use	381
keypad	381
LCD	381
recharging	382
thumbwheels	381
changing frequency	380
in ECU	352
in System Overview	10
operation modes	383
address check	383
channel check	383
dimmer check	383
live	384
park	383
patch	386
playback	385
overview	
base station receiver	379
handheld remote	378
recharging	382
technical specifications	387
USB settings	352
WiFi	
iRFR	343
range editing new fixtures	91
rate	
cue attribute	175
rate override	225
RDM	
device details	274
enable	343
recall from	229
record	
cue list	204
using {Record Only}	204
using {Record}	204
cues	
in live	165
using {Record Only}	166
using {Record}	165
cues in blind	186
filters, with	200
groups live	134
multipart cues	212
attributes	213
new cue list	204
using {Record Only}	204
using {Record}	204
palettes	142
with selective store	143
partial filters, with	201
presets	152
snapshots	284
submasters	258
record defaults	
setting	103

record filters	
storing data with	201
referenced marks	193
setting flags	193
timing	197
register your Ion	3
relative effects.	250
release	225
Release. <i>See Sneak</i>	
rem dim. <i>See remainder dim</i>	
remainder dim.	127
highlight	129
Remote	377
remote	
aRFR	388
iRFR.	388
phone	377
connector	377
functions	377
radio focus (RFR).	378
Remote Device Management	
<i>See RDM.</i>	
remote power off.	364
remote power on.	364
Remote Processor Unit (RPU)	
button configuration	351, 370
hardware setup	
front panel	369
rear panel.	368
in System Overview	10
start up.	369
remote software installation	364
Remote Video Interface (RVI)	
button configuration	351, 375
hardware setup	
front panel	375
rear panel.	374
in System Overview	10
start up.	375
remove	
channels	
from presets.	149, 158
referenced mark	194
replace	64
replace with.	188
rerecord palettes.	146
reset	
patch	87
RFR. <i>See Radio Focus Remote.</i>	
S	
save as.	57
saving	
existing show file	57
quick	57
scaled park.	237
scroller	
calibrating	72
calibration column	73
editing in patch	71
fan curves	71
scroller fans	
applying curves to	281
scroller picker.	68
scrolling displays	29
select channels	
keypad	112
select last	123
selecting	
displays	29
selective store	
negative	167
positive	167
with cues	167
Sensor feedback	
enable	343
Services	
ETC Technical.	3
settings	
attribute, in patch.	78
database, in patch.	80
patch	76
setup	95
desk settings	103
Displays.	107
Face Panel	105
manual control	
record defaults	103
MIDI	
show control	100
time code.	100
opening	96
show	96
show control	100
show settings.	96
cue settings.	99

fader configuration	98	spreadsheet view	41
SMPTTE	100	editing palettes in	148
show control		editing presets in	158
configure ports	352	modifying cues from	187
settings	100	modifying using {move to}	188
show control <i>See also the Eos Family</i>		modifying using {replace with}	188
<i>Show Control User Guide</i>		step effects	245
show file		stop effect	225
create	50	stop/back (key)	221
deleting	58	storing	
exporting	58	palettes	
importing	57	using {Record Only}	143
loading parts of	51	using {Record}	142
merging	54	presets	
name		using {Record Only}	153
bold	50	using {Record}	152
normal	50	using record filters	201
new	50	submaster	
open existing	50	additive	259
print	55	background state	261
quick save	57	effect	259
save as	57	exclusive	260
saving existing	57	HTP	260
show setup	96	independent	260
{show settings}	96	inhibitive	259
shutter control		intensity master	259
from encoders	120	LTP	260
slider module		priority	
opening	25	independent	260
with playbacks	220	shield	260
SMPTTE		proportional	259
setup	100	restore modes	261
snap parameters	93	shield	261
snapshots		submasters	
about	284	about	258
delete	285	bump button timing with	265
edit	285	clearing	264
recall	285	deleting	264
record	284	effects	254
sneak		list	266
<i>description</i>	130	editing from	266
softkeys		loading	263
about	47	manual control	265
changing pages	47	recording	258
context sensitive	47	updating	264
solo mode (softkey)		summary view	39
in cue list index	210	modifying cues from	187
split	43	swapping channels	66

synchronized backup	361
setup	361
syntax	
structure	4
using enter	5
system	
using about	269
System Components	10
T	
table view	40
editing presets in	157
modifying cues from	187
technical services	3
text indicators	
in live/blind	33
in playback status display	37
time	
bump buttons	265
cue	
setting	169
cues	169
delay	171, 173
disable in playback	224
discrete	172
go to cue	218
manual control of, in playback	222
setting for parameter categories	170
time /	171
time (navigation key)	35
time code	
MIDI	100
SMPTE	100
timing disable	
in playback	224
touchscreens	
Elo touchscreens	
calibrate	337
settings	347
ETC touchscreens	
calibrate	338
trace	
with update	184
Track mode	
deleting cues in	189
trackball	119

U

undo	
command history	234
using	234
unpatch a channel	66
break nested references	
with	181
update	181
cues	
using {Cue Only/Track}	183
without references	182
current cue	184
default modes	182
dialogue box	181
fixture library in show file	92
groups in live	135
inactive cues	184
modifiers	181
options	181
palette	146
presets	155
references	
in cues	182
source cue	184
styles	181
submasters	264
using trace	184
update dialogue box	181
user	
data between different IDs	328
ID	
about	328
assigning	328
relation to data sharing	328
multiple	311, 327
user ID	
relation to data sharing	360
with multiconsole	360

V

view	
spreadsheet, in blind	41
table	40
virtual faders	
assigning	220
virtual faders <i>See slider module</i>	25
virtual keyboard	24

virtual media server	312
media content.	312
patching	314
pixel map	315
pixel mapping in a multi-console system.	324
working with	317

W

web site.	3
wheel picker	68
working with a single cue list	163
working with multiple cue lists.	203





Corporate Headquarters ■ 3031 Pleasant View Road, P.O. Box 620979, Middleton, Wisconsin 53562-0979 USA ■ Tel +608 831 4116 ■ Fax +608 836 1736
London, UK ■ Unit 26-28, Victoria Industrial Estate, Victoria Road, London W3 6UU, UK ■ Tel +44 (0)20 8896 1000 ■ Fax +44 (0)20 8896 2000
Rome, IT ■ Via Pieve Torina, 48, 00156 Rome, Italy ■ Tel +39 (06) 32 111 683 ■ Fax +44 (0) 20 8752 8486
Holzkirchen, DE ■ Ohmstrasse 3, 83607 Holzkirchen, Germany ■ Tel +49 (80 24) 47 00-0 ■ Fax +49 (80 24) 47 00-3 00
Hong Kong ■ Rm 1801, 18/F, Tower 1 Phase 1, Enterprise Square, 9 Sheung Yuet Road, Kowloon Bay, Kowloon, Hong Kong ■ Tel +852 2799 1220 ■ Fax +852 2799 9325
Service: (Americas) service@etcconnect.com ■ (UK) service@etc europe.com ■ (DE) techserv-hoki@etcconnect.com ■ (Asia) service@etcasia.com
Web: www.etcconnect.com ■ Copyright © 2013 ETC. All Rights Reserved. ■ Product information and specifications subject to change.
4310M1210-2.0.0 ■ Rev A ■ Released 2013-03